

Project Gutenberg's Introduction to Infinitesimal Analysis  
by Oswald Veblen and N. J. Lennes

This eBook is for the use of anyone anywhere at no cost and with almost no restrictions whatsoever. You may copy it, give it away or re-use it under the terms of the Project Gutenberg License included with this eBook or online at [www.gutenberg.net](http://www.gutenberg.net)

Title: Introduction to Infinitesimal Analysis  
Functions of one real variable

Author: Oswald Veblen and N. J. Lennes

Release Date: July 2, 2006 [EBook #18741]

Language: English

Character set encoding: TeX

\*\*\* START OF THIS PROJECT GUTENBERG EBOOK INFINITESIMAL ANALYSIS \*\*\*

Produced by K.F. Greiner, Joshua Hutchinson, Laura Wisewell, Owen Whitby and the Online Distributed Proofreading Team at <http://www.pgdp.net> (This file was produced from images generously made available by Cornell University Digital Collections.)



### Transcriber's Notes.

A large number of printer errors have been corrected. These are shaded like this, and details can be found in the source code in the syntax `\correction{corrected}{original}`. In addition, the formatting of a few lemmas, corollaries etc. has been made consistent with the others.

The unusual inequality sign  $\overline{>}$  used a few times in the book in addition to  $\geq$  has been preserved, although it may reflect the printing rather than the author's intention. The notation  $\overline{a b}$  for intervals is not in common use today, and the reader able to run  $\text{\LaTeX}$  will find it easy to redefine this macro to give a modern equivalent. Similarly, the original did not mark the ends of proofs in any way and so nor does this version, but the reader who wishes can easily redefine `\qedsymbol` in the source.



INTRODUCTION  
TO  
INFINITESIMAL ANALYSIS  
FUNCTIONS OF ONE REAL VARIABLE

BY  
OSWALD VEBLER  
*Preceptor in Mathematics, Princeton University*  
AND  
N. J. LENNES  
*Instructor in Mathematics in the Wendell Phillips High School, Chicago*

*FIRST EDITION*  
FIRST THOUSAND

NEW YORK  
JOHN WILEY & SONS  
LONDON: CHAPMAN & HALL, LIMITED  
1907

Copyright, 1907  
BY  
OSWALD VEBLEN AND N. J. LENNES

ROBERT DRUMMOND, PRINTER, NEW YORK

# PREFACE

A course dealing with the fundamental theorems of infinitesimal calculus in a rigorous manner is now recognized as an essential part of the training of a mathematician. It appears in the curriculum of nearly every university, and is taken by students as “Advanced Calculus” in their last collegiate year, or as part of “Theory of Functions” in the first year of graduate work. This little volume is designed as a convenient reference book for such courses; the examples which may be considered necessary being supplied from other sources. The book may also be used as a basis for a rather short theoretical course on real functions, such as is now given from time to time in some of our universities.

The general aim has been to obtain rigor of logic with a minimum of elaborate machinery. It is hoped that the systematic use of the Heine-Borel theorem has helped materially toward this end, since by means of this theorem it is possible to avoid almost entirely the sequential division or “pinching” process so common in discussions of this kind. The definition of a limit by means of the notion “value approached” has simplified the proofs of theorems, such as those giving necessary and sufficient conditions for the existence of limits, and in general has largely decreased the number of  $\varepsilon$ 's and  $\delta$ 's. The theory of limits is developed for multiple-valued functions, which gives certain advantages in the treatment of the definite integral.

In each chapter the more abstract subjects and those which can be omitted on a first reading are placed in the concluding sections. The last chapter of the book is more advanced in character than the other chapters and is intended as an introduction to the study of a special subject. The index at the end of the book contains references to the pages where technical terms are first defined.

When this work was undertaken there was no convenient source in English containing a rigorous and systematic treatment of the body of theorems usually included in even an elementary course on real functions, and it was necessary to refer to the French and German treatises. Since then one treatise, at least, has appeared in English on the Theory of Functions of Real Variables. Nevertheless it is hoped that the present volume, on account of its conciseness, will supply a real want.

The authors are much indebted to Professor E. H. Moore of the University of Chicago for many helpful criticisms and suggestions; to Mr. E. B. Morrow of Princeton University for reading the manuscript and helping prepare the cuts; and to Professor G. A. Bliss of Princeton, who has suggested several desirable changes while reading the proof-sheets.





# Contents

<b>1</b>	<b>THE SYSTEM OF REAL NUMBERS.</b>	<b>1</b>
§ 1	Rational and Irrational Numbers. . . . .	1
§ 2	Axiom of Continuity. . . . .	2
§ 3	Addition and Multiplication of Irrationals. . . . .	6
§ 4	General Remarks on the Number System. . . . .	8
§ 5	Axioms for the Real Number System. . . . .	9
§ 6	The Number $e$ . . . . .	11
§ 7	Algebraic and Transcendental Numbers. . . . .	14
§ 8	The Transcendence of $e$ . . . . .	14
§ 9	The Transcendence of $\pi$ . . . . .	18
<b>2</b>	<b>SETS OF POINTS AND OF SEGMENTS.</b>	<b>23</b>
§ 1	Correspondence of Numbers and Points. . . . .	23
§ 2	Segments and Intervals. Theorem of Borel. . . . .	24
§ 3	Limit Points. Theorem of Weierstrass. . . . .	28
§ 4	Second Proof of Theorem 15. . . . .	31
<b>3</b>	<b>FUNCTIONS IN GENERAL. SPECIAL CLASSES OF FUNCTIONS.</b>	<b>33</b>
§ 1	Definition of a Function. . . . .	33
§ 2	Bounded Functions. . . . .	35
§ 3	Monotonic Functions; Inverse Functions. . . . .	36
§ 4	Rational, Exponential, and Logarithmic Functions. . . . .	41
<b>4</b>	<b>THEORY OF LIMITS.</b>	<b>47</b>
§ 1	Definitions. Limits of Monotonic Functions. . . . .	47
§ 2	The Existence of Limits. . . . .	51
§ 3	Application to Infinite Series. . . . .	55
§ 4	Infinitesimals. Computation of Limits. . . . .	58
§ 5	Further Theorems on Limits. . . . .	64
§ 6	Bounds of Indetermination. Oscillation. . . . .	65

<b>5</b>	<b>CONTINUOUS FUNCTIONS.</b>	<b>69</b>
§ 1	Continuity at a Point. . . . .	69
§ 2	Continuity of a Function on an Interval. . . . .	70
§ 3	Functions Continuous on an Everywhere Dense Set. . . . .	74
§ 4	The Exponential Function. . . . .	76
<b>6</b>	<b>INFINITESIMALS AND INFINITES.</b>	<b>81</b>
§ 1	The Order of a Function at a Point. . . . .	81
§ 2	The Limit of a Quotient. . . . .	84
§ 3	Indeterminate Forms . . . . .	86
§ 4	Rank of Infinitesimals and Infinites. . . . .	91
<b>7</b>	<b>DERIVATIVES AND DIFFERENTIALS.</b>	<b>93</b>
§ 1	Definition and Illustration of Derivatives. . . . .	93
§ 2	Formulas of Differentiation. . . . .	95
§ 3	Differential Notations. . . . .	102
§ 4	Mean-value Theorems. . . . .	104
§ 5	Taylor's Series. . . . .	107
§ 6	Indeterminate Forms. . . . .	111
§ 7	General Theorems on Derivatives. . . . .	115
<b>8</b>	<b>DEFINITE INTEGRALS.</b>	<b>121</b>
§ 1	Definition of the Definite Integral. . . . .	121
§ 2	Integrability of Functions. . . . .	124
§ 3	Computation of Definite Integrals. . . . .	128
§ 4	Elementary Properties of Definite Integrals. . . . .	132
§ 5	The Definite Integral as a Function of the Limits of Integration. . . . .	138
§ 6	Integration by Parts and by Substitution. . . . .	141
§ 7	General Conditions for Integrability. . . . .	143
<b>9</b>	<b>IMPROPER DEFINITE INTEGRALS.</b>	<b>153</b>
§ 1	The Improper Definite Integral on a Finite Interval. . . . .	153
§ 2	The Definite Integral on an Infinite Interval. . . . .	161
§ 3	Properties of the Simple Improper Definite Integral. . . . .	164
§ 4	A More General Improper Integral. . . . .	168
§ 5	Existence of Improper Definite Integrals on a Finite Interval . . . . .	174
§ 6	Existence of Improper Definite Integrals on the Infinite Interval . . . . .	178

# Chapter 1

## THE SYSTEM OF REAL NUMBERS.

### § 1 Rational and Irrational Numbers.

The real number system may be classified as follows:

- (1) All integral numbers, both positive and negative, including zero.
- (2) All numbers  $\frac{m}{n}$ , where  $m$  and  $n$  are integers ( $n \neq 0$ ).
- (3) Numbers not included in either of the above classes, such as  $\sqrt{2}$  and  $\pi$ .<sup>1</sup>

Numbers of classes (1) and (2) are called rational or commensurable numbers, while the numbers of class (3) are called irrational or incommensurable numbers.

As an illustration of an irrational number consider the square root of 2. One ordinarily says that  $\sqrt{2}$  is 1.4+, or 1.41+, or 1.414+, etc. The exact meaning of these statements is expressed by the following inequalities:<sup>2</sup>

$$\begin{aligned}(1.4)^2 &< 2 < (1.5)^2, \\(1.41)^2 &< 2 < (1.42)^2, \\(1.414)^2 &< 2 < (1.415)^2, \\&\text{etc.}\end{aligned}$$

Moreover, by the foot-note above no terminating decimal is equal to the square root of 2. Hence Horner's Method, or the usual algorithm for extracting the square root, leads to an

---

<sup>1</sup>It is clear that there is no number  $\frac{m}{n}$  such that  $\frac{m^2}{n^2} = 2$ , for if  $\frac{m^2}{n^2} = 2$ , then  $m^2 = 2n^2$ , where  $m^2$  and  $2n^2$  are integral numbers, and  $2n^2$  is the square of the integral number  $m$ . Since in the square of an integral number every prime factor occurs an even number of times, the factor 2 must occur an even number of times both in  $n^2$  and  $2n^2$ , which is impossible because of the theorem that an integral number has only one set of prime factors.

<sup>2</sup> $a < b$  signifies that  $a$  is less than  $b$ .  $a > b$  signifies that  $a$  is greater than  $b$ .

infinite sequence of rational numbers which may be denoted by  $a_1, a_2, a_3, \dots, a_n, \dots$  (where  $a_1 = 1.4, a_2 = 1.41$ , etc.), and which has the property that for every positive integral value of  $n$

$$a_n \leq a_{n+1}, \quad a_n^2 < 2 < \left(a_n + \frac{1}{10^n}\right)^2.$$

Suppose, now, that there is a *least* number  $a$  greater than every  $a_n$ . We easily see that if the ordinary laws of arithmetic as to equality and inequality and addition, subtraction, and multiplication hold for  $a$  and  $a^2$ , then  $a^2$  is the rational number 2. For if  $a^2 < 2$ , let  $2 - a^2 = \varepsilon$ , whence  $2 = a^2 + \varepsilon$ . If  $n$  were so taken that  $\frac{1}{10^n} < \frac{\varepsilon}{5}$ , we should have from the last inequality<sup>3</sup>

$$2 < \left(a_n + \frac{1}{10^n}\right)^2 = a_n^2 + 2a_n \cdot \frac{1}{10^n} + \left(\frac{1}{10^n}\right)^2 < a_n^2 + 4\frac{\varepsilon}{5} + \frac{\varepsilon}{5} < a^2 + \varepsilon,$$

so that we should have both  $2 = a^2 + \varepsilon$  and  $2 < a^2 + \varepsilon$ . On the other hand, if  $a^2 > 2$ , let  $a^2 - 2 = \varepsilon'$  or  $2 + \varepsilon' = a^2$ . Taking  $n$  such that  $\frac{1}{10^n} < \frac{\varepsilon'}{5}$ , we should have

$$\left(a_n + \frac{1}{10^n}\right)^2 < (a_n^2) + \varepsilon' < 2 + \varepsilon' < a^2;$$

and since  $a_n + \frac{1}{10^n}$  is greater than  $a_k$  for all values of  $k$ , this would contradict the hypothesis that  $a$  is the *least* number greater than every number of the sequence  $a_1, a_2, a_3, \dots$ . We also see without difficulty that  $a$  is the only number such that  $a^2 = 2$ .

## § 2 Axiom of Continuity.

The essential step in passing from ordinary rational numbers to the number corresponding to the symbol  $\sqrt{2}$  is thus made to depend upon an assumption of the existence of a number  $a$  bearing the unique relation just described to the sequence  $a_1, a_2, a_3, \dots$ . In order to state this hypothesis in general form we introduce the following definitions:

**Definition.**—The notation  $[x]$  denotes a *set*,<sup>4</sup> any element of which is denoted by  $x$  alone, with or without an index or subscript.

A set of numbers  $[x]$  is said to have an *upper bound*,  $M$ , if there exists a number  $M$  such that there is no number of the set greater than  $M$ . This may be denoted by  $M \geq [x]$ .

A set of numbers  $[x]$  is said to have a *lower bound*,  $m$ , if there exists a number  $m$  such that no number of the set is less than  $m$ . This we denote by  $m \leq [x]$ .

<sup>3</sup>This involves the assumption that for every number,  $\varepsilon$ , however small there is a positive integer  $n$  such that  $\frac{1}{10^n} < \frac{\varepsilon}{5}$ . This is of course obvious when  $\varepsilon$  is a rational number. If  $\varepsilon$  is an irrational number, however, the statement will have a definite meaning only after the irrational number has been fully defined.

<sup>4</sup>Synonyms of set are class, aggregate, collection, assemblage, etc.

Following are examples of sets of numbers:

- (1) 1, 2, 3.
- (2) 2, 4, 6, ..., 2*k*, ...
- (3) 1/2, 1/2<sup>2</sup>, 1/2<sup>3</sup>, ..., 1/2<sup>*n*</sup>, ...
- (4) All rational numbers less than 1.
- (5) All rational numbers whose squares are less than 2.

Of the first set 1, or any smaller number, is a lower bound and 3, or any larger number, is an upper bound. The second set has no upper bound, but 2, or any smaller number, is a lower bound. The number 3 is the least upper bound of the first set, that is, the smallest number which is an upper bound. The least upper and the greatest lower bounds of a set of numbers  $[x]$  are called by some writers the upper and lower limits respectively. We shall denote them by  $\overline{B}[x]$  and  $\underline{B}[x]$  respectively. By what precedes, the set (5) would have no least upper bound unless  $\sqrt{2}$  were counted as a number.

We now state our hypothesis of continuity in the following form:

**Axiom K.**—*If a set  $[r]$  of rational numbers having an upper bound has no rational least upper bound, then there exists one and only one number  $\overline{B}[r]$  such that*

- (a)  $\overline{B}[r] > r'$ , where  $r'$  is any number of  $[r]$  or any rational number less than some number of  $[r]$ .
- (b)  $\overline{B}[r] < r''$ , where  $r''$  is any rational upper bound of  $[r]$ .<sup>5</sup>

**Definition.**—The number  $\overline{B}[r]$  of [axiom K](#) is called the least upper bound of  $[r]$ , and as it cannot be a rational number it is called an *irrational* number. The set of all rational and irrational numbers so defined is called the *continuous real number system*. It is also called *the linear continuum*. The set of all real numbers between any two real numbers is likewise called a linear continuum.

**Theorem 1.** *If two sets of rational numbers  $[r]$  and  $[s]$ , having upper bounds, are such that no  $r$  is greater than every  $s$  and no  $s$  greater than every  $r$ , then  $\overline{B}[r]$  and  $\overline{B}[s]$  are the same; that is, in symbols,*

$$\overline{B}[r] = \overline{B}[s].$$

**Proof.** If  $\overline{B}[r]$  is rational, it is evident, and if  $\overline{B}[r]$  is irrational, it is a consequence of [Axiom K](#) that

$$\overline{B}[r] > s',$$

---

<sup>5</sup>This axiom implies that the new (irrational) numbers have relations of order with all the rational numbers, but does not explicitly state relations of order among the irrational numbers themselves. Cf. [Theorem 2](#).

where  $s'$  is any rational number not an upper bound of  $[s]$ . Moreover, if  $s''$  is rational and greater than every  $s$ , it is greater than every  $r$ . Hence

$$\overline{B}[r] < s'',$$

where  $s''$  is any rational upper bound of  $[s]$ . Then, by the definition of  $\overline{B}[s]$ ,

$$\overline{B}[r] = \overline{B}[s],$$

**Definition.**—If a number  $x$  (in particular an irrational number) is the least upper bound of a set of rational numbers  $[r]$ , then the set  $[r]$  is said to *determine* the number  $x$ .

*Corollary 1.* The irrational numbers  $i$  and  $i'$  determined by the two sets  $[r]$  and  $[r']$  are equal if and only if there is no number in either set greater than every number in the other set.

*Corollary 2.* Every irrational number is determined by some set of rational numbers.

**Definition.**—If  $i$  and  $i'$  are two irrational numbers determined respectively by sets of rational numbers  $[r]$  and  $[r']$  and if some number of  $[r]$  is greater than every number of  $[r']$ , then

$$i > i' \text{ and } i' < i.$$

From these definitions and the order relations among the rational numbers we prove the following theorem:

**Theorem 2.** *If  $a$  and  $b$  are any two distinct real numbers, then  $a < b$  or  $b < a$ ; if  $a < b$ , then not  $b < a$ ; if  $a < b$  and  $b < c$ , then  $a < c$ .*

**Proof.** Let  $a, b, c$  all be irrational and let  $[x], [y], [z]$  be sets of rational numbers determining  $a, b, c$ . In the two sets  $[x]$  and  $[y]$  there is either a number in one set greater than every number of the other or there is not. If there is no number in either set greater than every number in the other, then, by Theorem 1,  $a = b$ . If there is a number in  $[x]$  greater than every number in  $[y]$ , then no number in  $[y]$  is greater than every number in  $[x]$ . Hence the first part of the theorem is proved, that is, either  $a = b$  or  $a < b$  or  $b < a$ , and if one of these, then neither of the other two. If a number  $y_1$  of  $[y]$  is greater than every number of  $[x]$ , and a number  $z_1$  of  $[z]$  is greater than every number of  $[y]$ , then  $z_1$  is greater than every number of  $[x]$ . Therefore if  $a < b$  and  $b < c$ , then  $a < c$ .

We leave to the reader the proof in case one or two of the numbers  $a, b$ , and  $c$  are rational.

**Lemma.**—*If  $[r]$  is a set of rational numbers determining an irrational number, then there is no number  $r_1$  of the set  $[r]$  which is greater than every other number of the set.*

This is an immediate consequence of [axiom K](#).

**Theorem 3.** *If  $a$  and  $b$  are any two distinct numbers, then there exists a rational number  $c$  such that  $a < c$  and  $c < b$ , or  $b < c$  and  $c < a$ .*

**Proof.** Suppose  $a < b$ . When  $a$  and  $b$  are both rational  $\frac{b-a}{2}$  is a number of the required type. If  $a$  is rational and  $b$  irrational, then the theorem follows from the lemma and Corollary 2, page 4. If  $a$  and  $b$  are both irrational, it follows from Corollary 1, page 4. If  $a$  is irrational and  $b$  rational, then there are rational numbers less than  $b$  and greater than every number of the set  $[x]$  which determines  $a$ , since otherwise  $b$  would be the smallest rational number which is an upper bound of  $[x]$ , whereas by definition there is no least upper bound of  $[x]$  in the set of rational numbers.

*Corollary.*—A rational number  $r$  is the least upper bound of the set of all numbers which are less than  $r$ , as well as of the set of all rational numbers less than  $r$ .

**Theorem 4.** *Every set of numbers  $[x]$  which has an upper bound, has a least upper bound.*

**Proof.** Let  $[r]$  be the set of all rational numbers such that no number of the set  $[r]$  is greater than every number of the set  $[x]$ . Then  $\overline{B}[r]$  is an upper bound of  $[x]$ , since if there were a number  $x_1$  of  $[x]$  greater than  $\overline{B}[r]$ , then, by Theorem 3, there would be a rational number less than  $x_1$  and greater than  $\overline{B}[r]$ , which would be contrary to the definition of  $[r]$  and  $\overline{B}[r]$ . Further,  $\overline{B}[r]$  is the *least* upper bound of  $[x]$ , since if a number  $N$  less than  $\overline{B}[r]$  were an upper bound of  $[x]$ , then by Theorem 3 there would be rational numbers greater than  $N$  and less than  $\overline{B}[r]$ , which again is contrary to the definition of  $[r]$ .

**Theorem 5.** *Every set  $[x]$  of numbers which has a lower bound has a greatest lower bound.*

**Proof.** The proof may be made by considering the least upper bound of the set  $[y]$  of all numbers, such that every number of  $[y]$  is less than every number of  $[x]$ . The details are left to the reader.

**Theorem 6.** *If all numbers are divided into two sets  $[x]$  and  $[y]$  such that  $x < y$  for every  $x$  and  $y$  of  $[x]$  and  $[y]$ , then there is a greatest  $x$  or a least  $y$ , but not both.*

**Proof.** The proof is left to the reader.

The proofs of the above theorems are very simple, but experience has shown that not only the beginner in this kind of reasoning but even the expert mathematician is likely to make mistakes. The beginner is advised to write out for himself every detail which is omitted from the text.

Theorem 4 is a form of the continuity axiom due to Weierstrass, and 6 is the so-called *Dedekind Cut Axiom*. Each of Theorems 4, 5, and 6 expresses the *continuity* of the real number system.

### § 3 Addition and Multiplication of Irrationals.

It now remains to show how to perform the operations of addition, subtraction, multiplication, and division on these numbers. A definition of addition of irrational numbers is suggested by the following theorem: "If  $a$  and  $b$  are rational numbers and  $[x]$  is the set of all rational numbers less than  $a$ , and  $[y]$  the set of all rational numbers less than  $b$ , then  $[x + y]$  is the set of all rational numbers less than  $a + b$ ." The proof of this theorem is left to the reader.

**Definition.**—If  $a$  and  $b$  are not both rational and  $[x]$  is the set of all rationals less than  $a$  and  $[y]$  the set of all rationals less than  $b$ , then  $a + b$  is the least upper bound of  $[x + y]$ , and is called *the sum* of  $a$  and  $b$ .

It is clear that if  $b$  is rational,  $[x + b]$  is the same set as  $[x + y]$ ; for a given  $x + b$  is equal to  $x' + (b - (x' - x)) = x' + y'$ , where  $x'$  is any rational number such that  $x < x' < a$ ; and conversely, any  $x + y$  is equal to  $(x - b + y) + b = x'' + b$ . It is also clear that  $a + b = b + a$ , since  $[x + y]$  is the same set as  $[y + x]$ . Likewise  $(a + b) + c = a + (b + c)$ , since  $[(x + y) + z]$  is the same as  $[x + (y + z)]$ . Furthermore, in case  $b < a$ ,  $c = \overline{B}[x' - y']$ , where  $a < x' < b$  and  $a < y' < b$ , is such that  $b + c = a$ , and in case  $b < a$ ,  $c = \underline{B}[x' - y']$  is such that  $b + c = a$ ;  $c$  is denoted by  $a - b$  and called the *difference* between  $a$  and  $b$ . The *negative* of  $a$ , or  $-a$ , is simply  $0 - a$ . We leave the reader to verify that if  $a > 0$ , then  $a + b > b$ , and that if  $a < 0$ , then  $a + b < b$  for irrational numbers as well as for rationals.

The theorems just proved justify the usual method of adding infinite decimals. For example:  $\pi$  is the least upper bound of decimals like 3.1415, 3.14159, etc. Therefore  $\pi + 2$  is the least upper bound of such numbers as 5.1415, 5.14159, etc. Also  $e$  is the least upper bound of 2.7182818, etc. Therefore  $\pi + e$  is the least upper bound of 5, 5.8, 5.85, 5.859, etc.

The definition of multiplication is suggested by the following theorem, the proof of which is also left to the reader.

Let  $a$  and  $b$  be rational numbers not zero and let  $[x]$  be the set of all rational numbers between 0 and  $a$ , and  $[y]$  be the set of all rationals between 0 and  $b$ . Then if

$$\begin{array}{llll} a > 0, b > 0, & \text{it follows that} & ab = \overline{B}[xy]; \\ a < 0, b < 0, & \text{“ “ “} & ab = \overline{B}[xy]; \\ a < 0, b > 0, & \text{“ “ “} & ab = \underline{B}[xy]; \\ a > 0, b < 0, & \text{“ “ “} & ab = \underline{B}[xy]. \end{array}$$

**Definition.**—If  $a$  and  $b$  are not both rational and  $[x]$  is the set of all rational numbers between 0 and  $a$ , and  $[y]$  the set of all rationals between 0 and  $b$ , then if  $a > 0, b > 0$ ,  $ab$  means  $\overline{B}[xy]$ ; if  $a < 0, b < 0$ ,  $ab$  means  $\overline{B}[xy]$ ; if  $a < 0, b > 0$ ,  $ab$  means  $\underline{B}[xy]$ ; if  $a > 0, b < 0$ ,  $ab$  means  $\underline{B}[xy]$ . If  $a$  or  $b$  is zero, then  $ab = 0$ .

It is proved, just as in the case of addition, that  $ab = ba$ , that  $a(bc) = (ab)c$ , that if  $a$  is rational  $[ay]$  is the same set as  $[xy]$ , that if  $a > 0, b > 0, ab > 0$ . Likewise the quotient  $\frac{a}{b}$



is defined as a number  $c$  such that  $ac = b$ , and it is proved that in case  $a > 0$ ,  $b > 0$ , then  $c = \overline{B}\left[\frac{x}{y'}\right]$ , where  $[y']$  is the set of all rationals greater than  $b$ . Similarly for the other cases. Moreover, the same sort of reasoning as before justifies the usual method of multiplying non-terminated decimals.

To complete the rules of operation we have to prove what is known as the distributive law, namely, that

$$a(b + c) = ab + ac.$$

To prove this we consider several cases according as  $a$ ,  $b$ , and  $c$  are positive or negative. We shall give in detail only the case where all the numbers are positive, leaving the other cases to be proved by the reader. In the first place we easily see that for positive numbers  $e$  and  $f$ , if  $[t]$  is the set of all the rationals between 0 and  $e$ , and  $[T]$  the set of all rationals less than  $e$ , while  $[u]$  and  $[U]$  are the corresponding sets for  $f$ , then

$$e + f = \overline{B}[T + U] = \overline{B}[t + u].$$

Hence if  $[x]$  is the set of all rationals between 0 and  $a$ ,  $[y]$  between 0 and  $b$ ,  $[z]$  between 0 and  $c$ ,

$$b + c = \overline{B}[y + z] \quad \text{and hence} \quad a(b + c) = \overline{B}[x(y + z)].$$

On the other hand  $ab = \overline{B}[xy]$ ,  $ac = \overline{B}[xz]$ , and therefore  $ab + ac = \overline{B}[(xy + xz)]$ . But since the distributive law is true for rationals,  $x(y + z) = xy + xz$ . Hence  $\overline{B}[x(y + z)] = \overline{B}[(xy + xz)]$  and hence

$$a(b + c) = ab + ac.$$

We have now proved that the system of rational and irrational numbers is not only continuous, but also is such that we may perform with these numbers all the operations of arithmetic. We have indicated the method, and the reader may detail that every rational number may be represented by a terminated decimal,

$$a_k 10^k + a_{k-1} 10^{k-1} + \dots + a_0 + \frac{a_{-1}}{10} + \dots + \frac{a_{-n}}{10^n} = a_k a_{k-1} \dots a_0 a_{-1} a_{-2} \dots a_{-n},$$

or by a circulating decimal,

$$a_k a_{k-1} \dots a_0 a_{-1} a_{-2} \dots a_{-i} \dots a_{-j} a_{-i} \dots a_{-j} \dots,$$

where  $i$  and  $j$  are any positive integers such that  $i < j$ ; whereas every irrational number may be represented by a non-repeating infinite decimal,

$$a_k a_{k-1} \dots a_0 a_{-1} a_{-2} \dots a_{-n} \dots$$

The operations of raising to a power or extracting a root on irrational numbers will be considered in a later chapter (see page 41). An example of elementary reasoning with the symbol  $\overline{B}[x]$  is to be found on pages 12 and 14. For the present we need only that  $x^n$ , where  $n$  is an integer, means the number obtained by multiplying  $x$  by itself  $n$  times.

It should be observed that the essential parts of the definitions and arguments of this section are based on the assumption of continuity which was made at the outset. A clear understanding of the irrational number and its relations to the rational number was first reached during the latter half of the last century, and then only after protracted study and much discussion. We have sketched only in brief outline the usual treatment, since it is believed that the importance and difficulty of a full discussion of such subjects will appear more clearly after reading the following chapters.

Among the good discussions of the irrational number in the English language are: H. P. MANNING, *Irrational Numbers and their Representation by Sequences and Series*, Wiley & Sons, New York; H. B. FINE, *College Algebra*, Part I, Ginn & Co., Boston; DEDEKIND, *Essays on the Theory of Number* (translated from the German), Open Court Pub. Co., Chicago; J. PIERPONT, *Theory of Functions of Real Variables*, Chapters I and II, Ginn & Co., Boston.

## § 4 General Remarks on the Number System.

Various modes of treatment of the problem of the number system as a whole are possible. Perhaps the most elegant is the following: Assume the existence and defining properties of the positive integers by means of a set of postulates or axioms. From these postulates it is not possible to argue that if  $p$  and  $q$  are prime there exists a number  $a$  such that  $a \cdot p = q$  or  $a = \frac{q}{p}$ , i.e., in the field of positive integers the operation of division is not always possible. The set of all pairs of integers  $\{m, n\}$ , if  $\{mk, nk\}$  ( $k$  being an integer) is regarded as the same as  $\{m, n\}$ , form an example of a set of objects which can be added, subtracted, and multiplied according to the laws holding for positive integers, provided addition, subtraction, and multiplication are defined by the equations,<sup>6</sup>

$$\begin{aligned}\{m, n\} \otimes \{p, q\} &= \{mp, nq\} \\ \{m, n\} \oplus \{p, q\} &= \{mq + np, nq\}.\end{aligned}$$

The operations with the subset of pairs  $\{m, 1\}$  are exactly the same as the operations with the integers.

This example shows that no contradiction will be introduced by adding a further axiom to the effect that besides the integers there are numbers, called fractions, such that in the extended system division is possible. Such an axiom is added and the order relations among the fractions are defined as follows:

$$\frac{p}{q} < \frac{m}{n} \quad \text{if} \quad pn < qm.$$

By an analogous example<sup>7</sup> the possibility of negative numbers is shown and an axiom

---

<sup>6</sup>The details needed to show that these integer pairs satisfy the algebraic laws of operation are to be found in Chapter I, pages 5–12, of PIERPONT'S *Theory of Real Functions*. PIERPONT'S exposition differs from that indicated above, in that he says that the integer pairs actually *are* the fractions.

<sup>7</sup>Cf. PIERPONT, loc. cit., pages 12–19.

assuming their existence is justified. This completes the rational number system and brings the discussion to the point where this book begins.

Our [Axiom K](#), which completes the real number system, assuming that every bounded set has a least upper bound, should, as in the previous cases, be accompanied by an example to show that no contradiction with previous axioms is introduced by [Axiom K](#). Such an example is the set of all lower segments, a lower segment,  $S$ , being defined as any bounded set of rational numbers such that if  $x$  is a number of  $S$ , every rational number less than  $x$  is in  $S$ . For instance, the set of all rational numbers less than a rational number  $a$  is a lower segment. Of two lower segments one is always a subset of the other. We may denote that  $S$  is a subset of  $S'$  by the symbol

$$S \oplus S'.$$

According to the order relation,  $\oplus$ , every bounded set of lower segments  $[S]$  has a least upper bound, namely the lower segment, consisting of every number in any  $S$  of  $[S]$ . If  $S$  and  $T$  are lower segments whose least upper bounds are  $s$  and  $t$ , we may define

$$S \oplus T$$

and

$$S \otimes T$$

as those lower segments whose least upper bounds are  $s + t$  and  $s \times t$  respectively. It is now easy to see that the set of lower segments contains a subset that satisfies the same conditions as the rational numbers, and that the set as a whole satisfies [axiom K](#). The legitimacy of [axiom K](#) from the logical point of view is thus established, since our example shows that it cannot contradict any previous theorem of arithmetic.

Further axioms might now be added, if desired, to postulate the existence of imaginary numbers, e.g. of a number  $x$  for each triad of real numbers  $a, b, c$ , such that  $ax^2 + bx + c = 0$ . These axioms are to be justified by an example to show that they are not in contradiction with previous assumptions. The theory of the complex variable is, however, beyond the scope of this book.

## § 5 Axioms for the Real Number System.

A somewhat more summary way of dealing with the problem is to set down at the outset a set of postulates for the system of real numbers as a whole without distinguishing directly between the rational and the irrational number. Several sets of postulates of this kind have been published by E. V. HUNTINGTON in the 3d, 4th, and 5th volumes of the Transactions of the American Mathematical Society. The following set is due to HUNTINGTON.<sup>8</sup>

The system of real numbers is a set of elements related to one another by the rules of addition (+), multiplication ( $\times$ ), and magnitude or order (<) specified below.

---

<sup>8</sup>Bulletin of the American Mathematical Society, Vol. XII, page 228.

- A 1. Every two elements  $a$  and  $b$  determine uniquely an element  $a + b$  called their *sum*.
- A 2.  $(a + b) + c = a + (b + c)$ .
- A 3.  $(a + b) = (b + a)$ .
- A 4. If  $a + x = a + y$ , then  $x = y$ .
- A 5. There is an element  $z$ , such that  $z + z = z$ . (This element  $z$  proves to be unique, and is called 0.)
- A 6. For every element  $a$  there is an element  $a'$ , such that  $a + a' = 0$ .
- M 1. Every two elements  $a$  and  $b$  determine uniquely an element  $ab$  called their *product*; and if  $a \neq 0$  and  $b \neq 0$ , then  $ab \neq 0$ .<sup>9</sup>
- M 2.  $(ab)c = a(bc)$ .
- M 3.  $ab = ba$ .
- M 4. If  $ax = ay$ , and  $a \neq 0$ , then  $x = y$ .
- M 5. There is an element  $u$ , different from 0, such that  $uu = u$ . This element proves to be uniquely determined, and is called 1.
- M 6. For every element  $a$ , not 0, there is an element  $a''$ , such that  $aa'' = 1$ .
- A M 1.  $a(b + c) = ab + ac$ .
- O 1. If  $a \neq b$ , then either  $a < b$  or  $b < a$ .
- O 2. If  $a < b$ , then  $a \neq b$ .
- O 3. If  $a < b$  and  $b < c$ , then  $a < c$ .
- O 4. (Continuity.) If  $[x]$  is any set of elements such that for a certain element  $b$  and every  $x$ ,  $x < b$ , then there exists an element  $\bar{B}$  such that—
- (1) For every  $x$  of  $[x]$ ,  $x < \bar{B}$ ;
- (2) If  $y < \bar{B}$ , then there is an  $x_1$  of  $x$  such that  $y < x_1$ .
- A O 1. If  $x < y$ , then  $a + x < a + y$ .
- M O 1. If  $a > 0$  and  $b > 0$ , then  $ab > 0$ .

---

<sup>9</sup>The latter part of M 1 may be omitted from the list of axioms, since it can be proved as a theorem from A 4 and A M 1.

These postulates may be regarded as summarizing the properties of the real number system. Every theorem of real analysis is a logical consequence of them. For convenience of reference later on we summarize also the rules of operation with the symbol  $|x|$ , which indicates the “numerical” or “absolute” value of  $x$ . That is, if  $x$  is positive,  $|x| = x$ , and if  $x$  is negative,  $|x| = -x$ .

$$|x| + |y| \geq |x + y|. \quad (1)$$

$$\therefore \sum_{k=1}^n |x_k| \geq \left| \sum_{k=1}^n x_k \right|, \quad (2)$$

where  $\sum_{k=1}^n x_k = x_1 + x_2 + \dots + x_n$ .

$$||x| - |y|| \leq |x - y| = |y - x| \leq |x| + |y|. \quad (3)$$

$$|x \cdot y| = |x| \cdot |y|. \quad (4)$$

$$\frac{|x|}{|y|} = \left| \frac{x}{y} \right|. \quad (5)$$

$$\text{If } |x - y| < e_1, |y - z| < e_2, \text{ then } |x - z| < e_1 + e_2. \quad (6)$$

If  $[x]$  is any bounded set,

$$\overline{B}[x] - \underline{B}[x] = \overline{B}[x_1 - x_2]. \quad (7)$$

## § 6 The Number $e$ .

In the theory of the exponential and logarithmic functions (see page 76) the irrational number  $e$  plays an important rôle. This number may be defined as follows:

$$e = \overline{B}[E_n], \quad (1)$$

where

$$E_n = 1 + \frac{1}{1!} + \frac{1}{2!} + \dots + \frac{1}{n!},$$

where  $[n]$  is the set of all positive integers, and

$$n! = 1 \cdot 2 \cdot 3 \dots n.$$

It is obvious that (1) defines a finite number and not infinity, since

$$E_n = 1 + \frac{1}{1!} + \frac{1}{2!} + \dots + \frac{1}{n!} < 1 + 1 + \frac{1}{2} + \frac{1}{2^2} + \dots + \frac{1}{2^{n-1}} = 3 - \frac{1}{2^{n-1}}.$$

The number  $e$  may very easily be computed to any number of decimal places, as follows:

$$\begin{aligned}
 E_0 &= 1 \\
 \frac{1}{1!} &= 1 \\
 \frac{1}{2!} &= .5 \\
 \frac{1}{3!} &= .166666+ \\
 \frac{1}{4!} &= .041666+ \\
 \frac{1}{5!} &= .008333+ \\
 \frac{1}{6!} &= .001388+ \\
 \frac{1}{7!} &= .000198+ \\
 \frac{1}{8!} &= .000024+ \\
 \frac{1}{9!} &= .000002+ \\
 \hline
 E_9 &= 2.7182\dots
 \end{aligned}$$

**Lemma.**—If  $k > e$ , then  $E_k > e - \frac{1}{k!}$ .

**Proof.** From the definitions of  $e$  and  $E_n$  it follows that

$$e - E_k = \bar{B} \left[ \frac{1}{(k+1)!} + \frac{1}{(k+2)!} + \dots + \frac{1}{(k+l)!} \right],$$

where  $[l]$  is the set of all positive integers. Hence

$$e - E_k = \frac{1}{(k+1)!} \cdot \bar{B} \left[ 1 + \frac{1}{k+2} + \frac{1}{(k+2)(k+3)} + \dots + \frac{1}{(k+2)\dots(k+l)} \right],$$

or

$$e - E_k < \frac{1}{(k+1)!} \cdot e.$$

If  $k > e$ , this gives

$$E_k > e - \frac{1}{k!}.$$

**Theorem 7.**

$$e = \bar{B} \left[ \left( 1 + \frac{1}{n} \right)^n \right],$$

where  $[n]$  is the set of all positive integers.

**Proof.** By the binomial theorem for positive integers

$$\left(1 + \frac{1}{n}\right)^n = 1 + n \binom{n}{1} \frac{1}{n} + \frac{n(n-1)}{2!} \cdot \left(\frac{1}{n}\right)^2 + \dots + \left(\frac{1}{n}\right)^n.$$

Hence

$$\begin{aligned} E_n - \left(1 + \frac{1}{n}\right)^n &= \sum_{k=2}^n \left( \frac{1}{k!} - \frac{n(n-1)\dots(n-k+1)}{k! n^k} \right) \\ &= \sum_{k=2}^n \frac{n^k - n(n-1)\dots(n-k+1)}{k! n^k}, \\ &< \sum_{k=2}^n \frac{n^k - (n-k+1)^k}{k! n^k}. \end{aligned} \tag{a}$$

Hence by factoring

$$\begin{aligned} E_n - \left(1 + \frac{1}{n}\right)^n &< \sum_{k=2}^n \frac{(k-1)(n^{k-1} + n^{k-2}(n-k+1) + \dots + (n-k+1)^{k-1})}{k! n^k} \\ &< \sum_{k=2}^n \frac{(k-1)kn^{k-1}}{k! n^k} \\ &< \frac{1}{n} \sum_{k=2}^n \frac{(k-1)k}{k!} \end{aligned}$$

i.e.,

$$E_n - \left(1 + \frac{1}{n}\right)^n < \frac{1}{n} \left(1 + \sum_{l=1}^{n-2} \frac{1}{l!}\right) < \frac{e}{n}. \tag{b}$$

From (a)

$$E_n > \left(1 + \frac{1}{n}\right)^n \tag{1}$$

and from (b)

$$\left(1 + \frac{1}{n}\right)^n > E_n - \frac{e}{n}, \tag{2}$$

whence by the lemma

$$\left(1 + \frac{1}{n}\right)^n > e - \frac{1}{n!} - \frac{e}{n}. \tag{3}$$

From (1) it follows that  $e$  is an upper bound of

$$\left[ \left(1 + \frac{1}{n}\right)^n \right],$$

and from (3) it follows that no smaller number can be an upper bound. Hence

$$\overline{B} \left[ \left( 1 + \frac{1}{n} \right)^n \right] = e.$$

## § 7 Algebraic and Transcendental Numbers.

The distinction between rational and irrational numbers, which is a feature of the discussion above, is related to that between *algebraic* and *transcendental* numbers. A number is algebraic if it may be the root of an algebraic equation,

$$a_0x^n + a_1x^{n-1} + \dots + a_{n-1}x + a_n = 0,$$

where  $n$  and  $a_0, a_1, \dots, a_n$  are integers and  $n > 0$ . A number is transcendental if not algebraic. Thus every rational number  $\frac{m}{n}$  is algebraic because it is the root of the equation

$$nx - m = 0,$$

while every transcendental number is irrational. Examples of transcendental numbers are,  $e$ , the base of the system of natural logarithms, and  $\pi$ , the ratio of the circumference of a circle to its diameter.

The proof that these numbers are transcendental follows on page 14, though it makes use of infinite series which will not be defined before page 56, and the function  $e^x$ , which is defined on page 44.

The existence of transcendental numbers was first proved by J. LIOUVILLE, *Comptes Rendus*, 1844. There are in fact an infinitude of transcendental numbers between any two numbers. Cf. H. WEBER, *Algebra*, Vol. 2, p. 822. No *particular* number was proved transcendental till, in 1873, C. HERMITE (*Crelle's Journal*, Vol. 76, p. 303) proved  $e$  to be transcendental. In 1882 E. LINDEMANN (*Mathematische Annalen*, Vol. 20, p. 213) showed that  $\pi$  is also transcendental.

The latter result has perhaps its most interesting application in geometry, since it shows the impossibility of solving the classical problem of constructing a square equal in area to a given circle by means of the ruler and compass. This is because any construction by ruler and compass corresponds, according to analytic geometry, to the solution of a special type of algebraic equation. On this subject, see F. KLEIN, *Famous Problems of Elementary Geometry* (Ginn & Co., Boston), and WEBER and WELLSTEIN, *Encyclopädie der Elementarmathematik*, Vol. 1, pp. 418–432 (B. G. Teubner, Leipzig).

## § 8 The Transcendence of $e$ .

**Theorem 8.** *If  $c, c_1, c_2, c_3, \dots, c_n$  are integers (or zero but  $c \neq 0$ ), then*

$$c + c_1e + c_2e^2 + \dots + c_n e^n \neq 0. \tag{1}$$



**Proof.** The scheme of proof is to find a number such that when it is multiplied into (1) the product becomes equal to a whole number distinct from zero plus a number between +1 and -1, a sum which surely cannot be zero. To find this number  $N$ , we study the series<sup>10</sup> for  $e^k$ , where  $k$  is an integer  $\overline{\leq} n$ :

$$e^k = 1 + \frac{k}{1!} + \frac{k^2}{2!} + \frac{k^3}{3!} + \dots$$

Multiplying this series successively by the arbitrary factors  $i! \cdot b_i$ , we obtain the following equations:

$$\left. \begin{aligned} e^k \cdot 1! \cdot b_1 &= b_1 \cdot 1! + b_1 k \left( 1 + \frac{k}{2} + \frac{k^2}{2 \cdot 3} + \dots \right); \\ e^k \cdot 2! \cdot b_2 &= b_2 \cdot 2! \left( 1 + \frac{k}{1} \right) + b_2 \cdot k^2 \left( 1 + \frac{k}{3} + \frac{k^2}{3 \cdot 4} + \dots \right); \\ e^k \cdot 3! \cdot b_3 &= b_3 \cdot 3! \left( 1 + \frac{k}{1!} + \frac{k^2}{2!} \right) + b_3 \cdot k^3 \left( 1 + \frac{k}{4} + \frac{k^2}{4 \cdot 5} + \dots \right); \\ \dots & \dots \dots \dots \dots \dots \dots \dots \dots \dots \dots \dots \dots \dots \dots \dots \dots \\ e^k \cdot s! \cdot b_s &= b_s \cdot s! \left( 1 + \frac{k}{1!} + \frac{k^2}{2!} + \dots + \frac{k^{s-1}}{(s-1)!} \right) \\ & \quad + b_s \cdot k^s \left( 1 + \frac{k}{s+1} + \frac{k^2}{(s+1)(s+2)} + \dots \right). \end{aligned} \right\} \quad (2)$$

For the sake of convenience in notation the numbers  $b_1 \dots b_s$  may be regarded as the coefficients of an arbitrary polynomial

$$\phi(x) + b_0 + b_1x + b_2x^2 + \dots + b_sx^s,$$

the successive derivatives of which are

$$\begin{aligned} \phi'(x) &= b_1 + 2 \cdot b_2x + \dots + s \cdot b_s \cdot x^{s-1}, \\ & \dots \dots \dots \dots \dots \dots \dots \dots \dots \dots \dots \dots \dots \dots \dots \dots \\ \phi^{(m)}(x) &= b_m \cdot m! + b_{m+1} \cdot \frac{(m+1)!}{1!} \cdot x + \dots + b_s \cdot \frac{s!}{(s-m)!} \cdot x^{s-m}; \\ & \dots \dots \dots \dots \dots \dots \dots \dots \dots \dots \dots \dots \dots \dots \dots \dots \end{aligned}$$

The diagonal in (2) from  $b_1 \cdot 1!$  to  $b_s \cdot s! \frac{k^{s-1}}{(s-1)!}$  is obviously  $\phi'(k)$ , the next lower diagonal is  $\phi''(k)$ , etc. Therefore by adding equations (2) in this notation we obtain

$$\begin{aligned} e^k (1! b_1 + 2! b_2 + \dots + s! b_s) &= \phi'(k) + \phi''(k) + \dots \\ & \quad + \phi^{(s)}(k) + \sum_{m=1}^s b_m \cdot k^m \cdot R_{km}, \end{aligned} \quad (3)$$

in which

$$R_{km} = 1 + \frac{k}{m+1} + \frac{k^2}{(m+1)(m+2)} + \dots$$

---

<sup>10</sup>Cf. pages 56 and 78.

Remembering that  $\phi(x)$  is perfectly arbitrary, we note that if it were so chosen that

$$\phi'(k) = 0, \quad \phi''(k) = 0, \dots, \quad \phi^{(p-1)}(k) = 0,$$

for every  $k$  ( $k = 1, 2, 3, \dots, n$ ) then equations (2) and (3) could be written in the form

$$\begin{aligned} e^k(1! \cdot b_1 + 2! \cdot b_2 + \dots + s! \cdot b_s) &= \sum_{m=1}^s b_m \cdot k^m \cdot R_{km} \\ &+ b_p \cdot p! \\ &+ b_{p+1} \cdot (p+1)! \cdot \left(1 + \frac{k}{1!}\right) \\ &+ \dots \\ &+ b_s \cdot s! \left(1 + \frac{k}{1!} + \frac{k^2}{2!} + \dots + \frac{k^{s-p}}{(s-p)!}\right). \end{aligned} \quad (4)$$

A choice of  $\phi(x)$  satisfying the required conditions is

$$\phi(x) = (a_0 + a_1x + a_2x^2 + \dots + a_nx^n)^p \cdot \frac{x^{p-1}}{(p-1)!} = \frac{(f(x))^p \cdot x^{p-1}}{(p-1)!}, \quad (5)$$

where  $f(x) = (x-1)(x-2)(x-3)\dots(x-n)$ .

Every  $k$  ( $k = 1, 2, \dots, n$ ) is a  $p$ -tuple root of (5). Here  $p$  is still perfectly arbitrary, but the degree  $s$  of  $\phi(x)$  is  $np + p - 1$ . If  $\phi(x)$  is expanded and the result compared with

$$\phi(x) = b_0 + b_1x + \dots + b_sx^s,$$

it is plain that

$$b_0 = 0, \quad b_1 = 0, \quad \dots, \quad b_{p-2} = 0,$$

on account of the factor  $x^{p-1}$ , and

$$b_{p-1} = \frac{a_0^p}{(p-1)!}, \quad b_p = \frac{I_p}{(p-1)!}, \quad \dots, \quad b_s = \frac{I_s}{(p-1)!},$$

where  $I_p, I_{p+1}, \dots, I_s$ , are all integers. The coefficient of  $e^k$  in the left-hand member of (4) is therefore

$$N_p = a_0^p + \frac{I_p}{(p-1)!} \cdot p! + \frac{I_{p+1}}{(p-1)!} \cdot (p+1)! + \dots + \frac{I_s}{(p-1)!} \cdot s!$$

Whenever the arbitrary number  $p$  is prime and greater than  $a_0$ ,  $N_p$  is the sum of  $a_0^p$ , which cannot contain  $p$  as a factor, plus other integers each of which does contain the factor  $p$ .  $N_p$  is therefore *not zero and not divisible by  $p$* .

Further, since

$$\frac{(p+t)!}{(p-1)! \cdot r!} = p \frac{(p+1)(p+2)\dots(p+t)}{r!}$$

is an integer divisible by  $p$  when  $r \leq t$ , it follows that all the coefficients of the last block of terms in (4) contain  $p$  as a factor. Since  $k$  is also an integer, (4) evidently reduces to

$$N_p \cdot e^k = pW_{kp} + \sum_{m=1}^s b_m \cdot k^m \cdot R_{km},$$

where  $W_{kp}$  is an integer or zero, and this may be abbreviated to the form

$$N_p \cdot e^k = pW_{kp} + r_{kp}. \quad (6)$$

Before completing our proof we need to show that by choosing the arbitrary prime number  $p$  sufficiently large,  $r_{kp}$  can be made as small as we please. If  $\alpha$  is a number greater than  $n$ ,

$$\begin{aligned} |R_{km}| &= \left| 1 + \frac{k}{m+1} + \frac{k^2}{(m+1)(m+2)} + \dots \right| \\ &< \left| 1 + \frac{\alpha}{m+1} + \frac{\alpha^2}{(m+1)(m+2)} + \dots \right| \\ &< \left| 1 + \frac{\alpha}{1} + \frac{\alpha^2}{2!} + \dots \right| \\ &< e^\alpha \end{aligned}$$

for all integral values of  $m$  and of  $k \leq n$ .

$$|r_{kp}| = \left| \sum_{m=1}^s b_m \cdot k^m \cdot R_{km} \right| \leq \sum_{m=1}^s |b_m| \cdot k^m \cdot |R_{k,m}|.$$

Since the number  $b_m$  is the coefficient of  $x^m$  in  $\phi(x)$  and since each coefficient of  $\phi(x)$  is numerically less than or equal to the corresponding coefficient of

$$\frac{x^{p-1}}{(p-1)!} (|a_0| + |a_1|x + |a_2|x^2 + \dots + |a_n|x^n)^p,$$

it follows that

$$\begin{aligned} |r_{kp}| &< e^\alpha \cdot \frac{\alpha^{p-1}}{(p-1)!} (|a_0| + |a_1|\alpha + \dots + |a_n|\alpha^n)^p \\ &< \frac{Q^p}{(p-1)!} \cdot e^\alpha, \end{aligned}$$

where

$$Q = \alpha(|a_0| + |a_1|\alpha + \dots + |a_n|\alpha^n)$$

is a constant not dependent on  $p$ . The expression  $\frac{Q^p}{(p-1)!}$  is the  $p$ th term of the series for  $Qe^Q$ , and therefore by choosing  $p$  sufficiently large  $r_{kp}$ , may be made as small as we please.

If now  $p$  is chosen as a prime number, greater than  $\alpha$  and  $\alpha_0$  and so great that for every  $k$ ,

$$r_{kp} < \frac{1}{n \cdot d},$$

where  $d$  is the greatest of the numbers

$$c, c_1, c_2, c_3, \dots, c_n,$$

the equations (6) evidently give

$$\begin{aligned} N_p(c + c_1e + c_2e^2 + \dots + c_ne^n) \\ &= N_p c + p(c_1W_{1p} + c_2W_{2p} + \dots + c_nW_{np}) \\ &\quad + c_1r_{1p} + c_2r_{2p} + \dots + c_nr_{np}, \\ &= N_p c + pW + R, \end{aligned} \tag{8}$$

where  $W$  is an integer or zero and  $R$  is numerically less than unity. Since  $N_p c$  is not divisible by  $p$  and is not zero, while  $pW$  is divisible by  $p$ , this sum is numerically greater than or equal to zero. Hence

$$N_p(c + c_1e + c_2e^2 + \dots + c_ne^n) \neq 0.$$

Hence

$$c + c_1e + c_2e^2 + \dots + c_ne^n \neq 0,$$

and  $e$  is a transcendental number.

## § 9 The Transcendence of $\pi$ .

The definition of the number  $\pi$  is derived from EULER's formula

$$e^{x\sqrt{-1}} = \cos x + \sqrt{-1} \sin x;$$

by replacing  $x$  by  $\pi$ ,

$$e^{\pi\sqrt{-1}} = -1. \tag{1}$$

If  $\pi$  is assumed to be an algebraic number,  $\pi\sqrt{-1}$  is also an algebraic number and is the root of an irreducible algebraic equation  $F(x) = 0$  whose coefficients are integers. If the roots of this equation are denoted by  $z_1, z_2, z_3, \dots, z_n$ , then, since  $\pi\sqrt{-1}$  is one of the  $z$ 's, it follows as a consequence of (1) that

$$(e^{z_1} + 1)(e^{z_2} + 1)(e^{z_3} + 1) \dots (e^{z_n} + 1) = 0. \tag{2}$$

By expanding (2)

$$1 + \sum e^{z_i} + \sum e^{z_i+z_j} + \sum e^{z_i+z_j+z_k} + \dots = 0.$$

Among the exponents zero may occur a number of times e.g.,  $(c - 1)$  times. If then

$$z_i, \quad z_i + z_j, \quad z_i + z_j + z_k, \quad \dots,$$

be designated by  $x_1, x_2, x_3, \dots, x_n$ , the equation becomes

$$c + e^{x_1} + e^{x_2} + \dots + e^{x_n} = 0, \tag{3}$$

where  $c$  is a positive number at least unity and the numbers  $x_i$  are algebraic. These numbers, by an argument for which the reader is referred to WEBER and WELLSTEIN'S *Encyclopädie der Elementarmathematik*, p. 427 et seq., may be shown to be the roots of an algebraic equation

$$f(x) = a_0 + a_1x + a_2x^2 + \dots + a_nx^n = 0, \tag{3'}$$

the coefficients being integers and  $a_0 \neq 0$  and  $a_n \neq 0$ . The rest of the argument consists in showing that equation (3) is impossible when  $x_1, x_2, \dots, x_n$  are roots of (3'). The process is analogous to that in § 8.

$$\left. \begin{aligned} e^{x_k} \cdot 1! b_1 &= b_1 \cdot 1! + b_1 x_k \left( 1 + \frac{x_k}{2} + \frac{x_k^2}{2 \cdot 3} + \dots \right), \\ e^{x_k} \cdot 2! b_2 &= b_2 \cdot 2! \left( 1 + \frac{x_k}{1!} \right) + b_2 x_k^2 \left( 1 + \frac{x_k}{3} + \frac{x_k^2}{3 \cdot 4} + \dots \right), \\ e^{x_k} \cdot 3! b_3 &= b_3 \cdot 3! \left( 1 + \frac{x_k}{1!} + \frac{x_k^2}{2!} \right) + b_3 x_k^3 \left( 1 + \frac{x_k}{4} + \frac{x_k^2}{4 \cdot 5} + \dots \right), \\ &\dots \dots \dots \dots \dots \dots \dots \dots \dots \dots \dots \dots \dots \dots \dots \dots \dots \dots \dots \\ e^{x_k} \cdot s! b_s &= b_s \cdot s! \left( 1 + \frac{x_k}{1!} + \dots + \frac{x_k^{s-1}}{(s-1)!} \right) \\ &\quad + b_s x_k^s \left( 1 + \frac{x_k}{s+1} + \frac{x_k^2}{(s+1)(s+2)} + \dots \right). \end{aligned} \right\} \tag{4}$$

The numbers  $b_1, \dots, b_s$  may be regarded as the coefficients of an arbitrary polynomial

$$\phi(x) = b_0 + b_1x + b_2x^2 + \dots + b_sx^s,$$

for which

$$\phi^{(m)}(x) = b_m \cdot m! + b_{m+1} \cdot \frac{(m+1)!}{1!} \cdot x + \dots + b_s \frac{s!}{(s-m)!} \cdot x^{s-m}.$$

The diagonal in equations (4) from  $b_1 \cdot 1!$  to  $b_s \cdot s! \frac{x_k^{s-1}}{(s-1)!}$  is obviously  $\phi'(x_k)$ , and the next lower diagonal  $\phi''(x_k)$ , etc. Therefore, by adding equations (4),

$$\begin{aligned} e^{x_k} (1! b_1 + 2! b_2 + \dots + s! b_s) &= \phi'(x_k) + \phi''(x_k) + \dots \\ &\quad + \phi^{(s)}(x_k) + \sum_{m=1}^s b_m \cdot x_k^m R_{km}, \end{aligned} \tag{5}$$

in which

$$R_{km} = 1 + \frac{x_k}{m+1} + \frac{x_k^2}{(m+1)(m+2)} + \dots$$

Remembering that  $\phi(x)$  is perfectly arbitrary, let it be so chosen that

$$\phi'(x_k) = 0, \phi''(x_k) = 0, \phi'''(x_k) = 0, \dots, \phi^{(p-1)}(x_k) = 0$$

for every  $x_k$ .

Equation (5) may then be written as follows:

$$\begin{aligned} e^{x_k}(1!b_1 + 2!b_2 + \dots + s!b_s) &= \sum_{m=1}^s b_m \cdot (x_k)^m \cdot R_{km} \\ &+ b_p \cdot p! \\ &+ b_{p+1} \cdot (p+1)! \left(1 + \frac{x_k}{1!}\right) \\ &+ \dots \\ &+ b_s \cdot s! \left(1 + \frac{x_k}{1!} + \frac{x_k^2}{2!} + \dots + \frac{x_k^{s-p}}{(s-p)!}\right). \end{aligned} \quad (6)$$

A choice of  $\phi(x)$  satisfying the required conditions is

$$\begin{aligned} \phi(x) &= \frac{a_n^{np-1} \cdot x^{p-1}}{(p-1)!} (a_0 + a_1x + a_2x^2 + \dots + a_nx^n)^p \\ &= \frac{a_n^{np-1} \cdot x^{p-1}}{(p-1)!} (f(x))^p, \end{aligned}$$

of which every  $x_k$  is a  $p$ -tuple root. If  $\phi(x)$  is expanded and the result compared with

$$\phi(x) = b_0 + b_1x + \dots + b_sx^s,$$

it is plain that  $b_0 = 0, b_1 = 0, \dots, b_{p-2} = 0$ , on account of the factor  $x^{p-1}$ ; and

$$b_{p-1} = \frac{a_0^p a_n^{np-1}}{(p-1)!}, \quad b_p = \frac{I_p \cdot a_n^{np-1}}{(p-1)!} \quad \dots, \quad b_s = \frac{I_s \cdot a_n^{np-1}}{(p-1)!},$$

where  $I_p, \dots, I_s$ , are all integers. The coefficient of  $e^{x_k}$  in (6) may now be written

$$N_p = a_n^{np-1} \left( a_0^p + \frac{I_p}{(p-1)!} \cdot p! + \frac{I_{p+1}}{(p-1)!} (p+1)! + \dots + \frac{I_s}{(p-1)!} \cdot s! \right).$$

If the arbitrary number  $p$  is chosen as a prime number greater than  $a_0$  and  $a_n$ ,  $N_p$  becomes the sum of  $a_0^p a_n^{np-1}$ , which cannot contain  $p$  as a factor, and a number of other integers each of which is divisible by  $p$ .  $N_p$  therefore is *not zero and not divisible by  $p$* .

Further, since,  $\frac{(p+t)!}{(p-1)! \cdot t!}$  is an integer divisible by  $p$  when  $r \leq t$ , it follows that all of the coefficients of the last block of terms in (6) contain  $p$  as a factor. If then (6) is added by columns,

$$N_p e^{\overline{x_k}} = p a_n^{np-1} [P_0 + P_1 x_k + P_2 x_k^2 + \dots + P_{s-p} x_k^{s-p}] + \sum_{m=1}^s b_m \cdot x_k^m \cdot R_{km} \quad (7)$$

where  $P_0, P_1, \dots, P_{s-p}$  are integers.

It remains to show that  $\sum_{m=1}^s b_m \cdot x_k^m \cdot R_{km}$  can be made small at will by a suitable choice of the arbitrary  $p$ . As in the proof of the transcendence of  $e$ , it follows that

$$|r_{kp}| = \left| \sum_{m=1}^s b_m \cdot x_k^m \cdot R_{km} \right| < \frac{Q^p}{(p-1)!} \cdot e^\alpha,$$

where

$$Q = |a_n^n| \alpha (|a_0| + |a_1| \alpha + \dots + |a_n| \alpha),$$

and  $\alpha$  is the largest of the absolute values of  $x_k$  ( $k = 1, \dots, n$ ). If now  $p$  is chosen as a prime number, greater than unity, greater than  $a_0 \dots a_n$  and greater than  $c$ , and so great also that  $|r_{kp}| < \frac{1}{n}$ , it follows directly from equation (7) that

$$\begin{aligned} N_p (c + e^{x_1} + e^{x_2} + \dots + e^{x_n}) \\ = N_p c + p a_n^{np-1} (P_0 S_0 + P_1 S_1 + \dots + P_{s-p} S_{s-p}) + \sum_{k=1}^n r_{kp}, \end{aligned} \quad (8)$$

where

$$|r_{kp}| = \left| \sum_{m=1}^s b_m \cdot x_k^m \cdot R_{km} \right| < \frac{1}{n},$$

$S_0 = n$ , and  $S_i = x_1^i + x_2^i + x_3^i + \dots + x_n^i$ , and therefore

$$S_1 = -\frac{a_{n-1}}{a_n}, \quad S_2 = \frac{a_{n-1}^2}{a_n^2} - \frac{2a_{n-2}}{a_n}, \dots, \quad 11$$

and therefore it follows that  $a_n^{np-1} S_1, a_n^{np-1} S_2, \dots$ , are all whole numbers or zero. The term

$$p a_n^{np-1} \cdot \sum_{i=0}^{s-p} P_i S_i$$

is therefore an integer divisible by  $p$ , while, on the contrary,  $N_p$  and  $c$  are not divisible by  $p$ .

The sum of these terms is therefore a whole number  $\geq +1$  or  $\leq -1$ , and since  $\sum_{k=1}^n r_{kp} < 1$ , the entire right-hand member of (8) is not zero, and hence (3) is not zero. Therefore—

**Theorem 9.** *The number  $\pi$  is transcendental.*

---

<sup>11</sup>Cf. BURNSIDE and PANTON *Theory of Equations*, Chapter VIII, Vol. I.





## Chapter 2

# SETS OF POINTS AND OF SEGMENTS.

### § 1 Correspondence of Numbers and Points.

The system of real numbers may be set into one-to-one correspondence with the points of a straight line. That is, a scheme may be devised by which every number corresponds to one and only one point of the line and vice versa. The point 0 is chosen arbitrarily, and the points  $1, 2, 3, 4, \dots$  are at regular intervals to the right of 0 in the order  $1, 2, 3, 4, \dots$  from left to right, while the points  $-1, -2, -3, \dots$  follow at regular intervals in the order  $0, -1, -2, -3, \dots$  from right to left. The points which correspond to fractional numbers are at intermediate positions as follows:<sup>1</sup>

To fix our ideas we obtain a point corresponding to a particular decimal of a finite number of digits, say 1.32. Divide the segment  $\overline{12}$  into ten equal parts. Then divide the

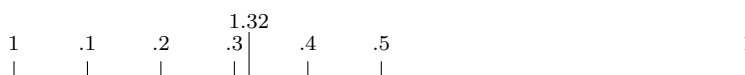

FIG. 1

segment  $\overline{.34}$  of this division into ten equal parts. The point marked 2 by the last division is the point corresponding to 1.32.

If the decimal is not terminating, we simply obtain an infinite sequence of points, such that any one is to the right of all that precede it, in case of a positive number, or to the left in case of a negative number. The first few points of the sequence for the number  $\pi$  are the points corresponding to the numbers 3, 3.1, 3.14, 3.141. This set of numbers is bounded, 4, for instance, being an upper bound. Hence the points corresponding to these numbers all lie to the left of the point corresponding to the number 4. To show that there exists a definite point corresponding to the least upper bound  $\overline{B}$  of the set of numbers 3, 3.1, 3.14, 3.141, etc., use is made of the following:

---

<sup>1</sup>It is convenient to think of numbers in this case as simply a notation for points. In view of the correspondence of points and numbers the numbers furnish a complete notation for all points.

**Postulate of Geometric Continuity.**—*If a set  $[x]$  of points of a line has a right bound, that is, if there exists a point  $B$  on the line such that no point of the set  $[x]$  is to the right of  $B$ , then there exists a leftmost right bound  $\overline{B}$  of the set  $[x]$ . If the set has a left bound, it has a rightmost left bound.*

The leftmost right bound of the set of points corresponding to the numbers 3., 3.1, 3.14, etc., is the point which corresponds to the number  $\pi$ . In the same manner it follows from the postulate that there is a definite point on the line corresponding to any decimal with an infinitude of digits.<sup>2</sup>

Conversely, given any point on the line, e.g., a point  $P$ , to the right of 0, there corresponds to it one and only one number. This is evident since, in dividing the line according to a decimal scale, either the point in question is one of the division-points, in which case the number corresponding to the point is a terminating decimal, or in case it is not a division-point we will have an infinite set of division-points to the left of it, the point in question being the leftmost right bound of the set. If now we pick out the rightmost point of this left set in every division and note the corresponding number, we have a set of numbers whose least upper bound corresponds to the point  $P$ .

The ordinary analytic geometry furnishes a scheme for setting all pairs of real numbers into correspondence with all points of a plane, and all triples of real numbers into correspondence with all points in space. Indeed, it is upon this correspondence that the analytic geometry is based.

It should be noticed that the correspondence between numbers and points on the line preserves order, that is, if we have three numbers,  $a, b, c$ , so that  $a < b < c$ , then the corresponding points  $A, B, C$  are under the ordinary conventions so arranged that  $B$  is to the right of  $A$ , and  $C$  to the right of  $B$ .

It will be observed that we have not put this matter of the one-to-one correspondence between points and numbers into the form of a theorem. Rather than aiming at a rigorous demonstration from a body of sharply stated axioms, we have attempted to place the subject-matter before the reader in such a manner that he will understand on the one hand the necessity, and on the other the grounds, for the hypothesis.

## § 2 Segments and Intervals. Theorem of Borel.

**Definition.**—A *segment*  $\overline{a b}$  is the set of all numbers greater than  $a$  and less than  $b$ . It does not include its end-points  $a$  and  $b$ . An *interval*  $\overline{\overline{a b}}$  is the segment  $\overline{a b}$  together with  $a$  and  $b$ . For a segment plus its end point  $a$  we use the notation  $\overline{a b}$ , and when  $a$  is absent

<sup>2</sup>It is not implied here, of course, that it is possible to write a decimal with an infinitude of digits, or to mark the corresponding points. What is meant is that if an infinite sequence of digits is determined, a definite number and a definite point are thereby determined. Thus  $\sqrt{2}$  determines an infinite sequence of digits, that is, it furnishes the law whereby the sequence can be extended at will.

and  $b$  present  $\overline{a} \overline{b}$ . All these notations imply that  $a < b$ .<sup>3</sup> Sometimes we denote a segment or interval by a single letter. This is done in case it is not important to designate a definite segment or interval.

The set of all numbers greater than  $a$  is the *infinite segment*  $\overline{a} \infty$ , and the set of all numbers less than  $a$  is the infinite segment  $\infty \overline{a}$ . The infinite segments  $\overline{a} \infty$  and  $\infty \overline{a}$ , together with the point  $a$ , are respectively the infinite intervals  $\overline{a} \infty$  and  $\infty \overline{a}$ . Unless otherwise specified the expressions *segment* and *interval* will be understood to refer to segments and intervals whose end-points are finite.

By means of the one-to-one correspondence of numbers and points on a line we define the length of a segment as follows: The length of a segment  $\overline{a} \overline{b}$  with respect to the unit segment  $\overline{0} \overline{1}$  is the number  $|a - b|$ . This definition applies equally to all segments whether they are commensurable or incommensurable with the unit segment.

**Definition.**—A set of segments or intervals  $[\sigma]$  covers a segment or interval  $t$  if every point of  $t$  is a point of some  $\sigma$ .

On the interval  $\overline{-1} \overline{1}$  consider the set of points  $[\frac{1}{2^n}]$ . The set of intervals  $\overline{-1} \overline{0}, \overline{\frac{1}{2}} \overline{1}$ ,

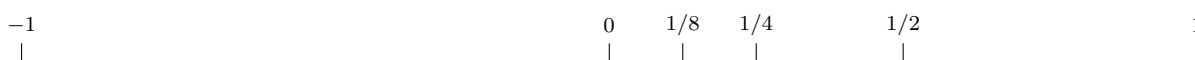

FIG. 2

$\overline{\frac{1}{4}} \overline{\frac{1}{2}}, \dots, \overline{\frac{1}{2^n}} \overline{\frac{1}{2^{n-1}}}, \dots$  covers the interval  $\overline{-1} \overline{1}$ , because every point of  $\overline{-1} \overline{1}$  is a point of one of the intervals. On the other hand a set of segments  $\overline{-1} \overline{0}, \overline{\frac{1}{2}} \overline{1}, \dots, \overline{\frac{1}{2^n}} \overline{\frac{1}{2^{n-1}}}, \dots$ , etc., does not cover the interval because it does not include the points  $-1, 1, \frac{1}{2}, \dots, \frac{1}{2^n}, \dots$ , or  $0$ . In order to obtain a set of segments which does cover the interval, it is necessary to adjoin a set of segments, no matter how small, such that one includes  $-1$ , one includes  $0$ , one includes  $1, \frac{1}{2}, \frac{1}{4}, \dots$ .

The segment including  $0$ , no matter how small it is, must include an infinitude of the points  $\frac{1}{2^n}$ , and there are only a finite number of them which do not lie on that segment. It therefore follows that in this enlarged set there is a subset of segments, finite in number,

which includes all the points of  $\overline{-1} \overline{1}$ . This turns out to be a general theorem, namely, that if any set of segments covers an interval, there is a finite subset of it which also covers the interval. The example we have just given shows that such a theorem is not true of the covering of an interval by a set of intervals; furthermore, it is not true of the covering of a segment either by a set of segments or by a set of intervals.

---

<sup>3</sup>The notation  $\overline{a} \overline{b}, \overline{a} b, a \overline{b}$ , etc., to denote the presence or absence of end-points is due to G. PEANO, *Analisi Infinitesimali*. Torino, 1893.

**Theorem 10<sup>4</sup>.** If an interval  $\overline{a b}$  is covered by any set  $[\sigma]$  of segments, it is covered by a finite number of segments  $\sigma_1, \dots, \sigma_n$  of  $[\sigma]$ .

**Proof.** It is evident that at least a part of  $\overline{a b}$  is covered by a finite number of  $\sigma$ 's; for example, if  $\sigma_0$  is the  $\sigma$  or one of the  $\sigma$ 's which include  $a$  and if  $b'$  is any point of  $\overline{a b}$  which lies in  $\sigma_0$ , then  $\overline{a b'}$  is covered by  $\sigma_0$ . Let  $[b']$  be the set of all points of  $\overline{a b}$ , such that  $\overline{a b'}$  is covered by a finite number of  $\sigma$ 's. By Theorem 4  $[b']$  has a least upper bound  $B$ . To complete our proof we show (a) that  $B$  is in  $[b']$ , and (b) that  $B = b$ .

- (a) Let  $\overline{a'' b''}$  be a segment of  $[\sigma]$  including  $B$ . Since  $B$  is the least upper bound of  $[b']$ , there is a point of  $[b']$ ,  $b'$ , between  $a''$  and  $B$ . But if  $\sigma_1, \sigma_2, \dots, \sigma_e$ , be the finite set of segments covering the interval  $\overline{a b'}$ , this set together with  $\overline{a'' b''}$  will cover  $\overline{a B}$ , which proves that  $B$  is a point of  $[b']$ .
- (b) If  $B \neq b$ , then  $B < b$  and the set  $\sigma_1, \sigma_2, \dots, \sigma_e$ , together with  $\overline{a'' b''}$ , would cover an interval  $\overline{a c}$ , where  $c$  is a point between  $B$  and  $b''$ ;  $c$  would therefore be a point of  $[b']$ , which is contrary to the hypothesis that  $B$  is an upper bound of  $[b']$ . Hence  $B = b$  and the theorem is proved.

An immediate consequence of this theorem is the following, which may be called the *theorem of uniformity*.

**Theorem 11.** If an interval  $\overline{a b}$  is covered by a set of segments  $[\sigma]$ , then  $\overline{a b}$  may be divided into  $N$  equal intervals such that each interval is entirely within a  $\sigma$ .

**Proof.** By Theorem 10  $\overline{a b}$  is covered by a finite set of  $\sigma$ 's,  $\sigma_1, \sigma_2, \dots, \sigma_n$ . The end points of these  $\sigma$ 's, together with  $a$  and  $b$ , are a finite set of points. Let  $d$  be the smallest distance between any two distinct points of this set. Because of the overlapping of the  $\sigma$ 's, any two points not in the same segment are separated by at least two end points. Therefore any two points whose distance apart is less than  $d$  must lie on the same segment of  $\sigma_1, \sigma_2, \dots, \sigma_n$ . Now let  $N$  be such that  $\frac{b-a}{N} < d$ , then each interval of length  $\frac{b-a}{N}$  is contained in a  $\sigma$ .

By this argument we have also proved the following:

---

<sup>4</sup>This theorem is due to E. BOREL, *Annales de l'École Normale Supérieure*, 3d series, Vol. 12 (1895), p. 51. It is frequently referred to as the HEINE-BOREL theorem, because it is essentially involved in the proof of the theorem of uniform continuity given by E. Heine, *Die Elemente der Functionenlehre*, Crelle's Journal, Vol. 74 (1872), page 188.

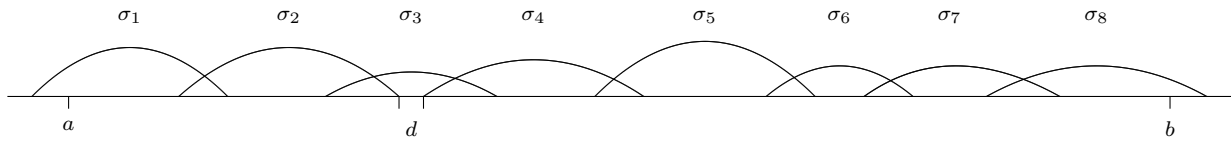

FIG. 3.

**Theorem 12.** If an interval  $\overline{a b}$  is covered by a set of segments, then there is a number  $d$  such that for any two numbers  $x_1$  and  $x_2$  such that  $a \leq x_1 < x_2 \leq b$  and  $|x_1 - x_2| < d$ , there is a segment  $\sigma$  of  $[\sigma]$  which contains both  $x_1$  and  $x_2$ . In other words, any interval of length  $d$  lies entirely within some  $\sigma$ .

The sense in which these are theorems of uniformity is the following. Any point  $x$  of  $\overline{a b}$ , being within a segment  $\sigma$ , can be regarded as the middle point of an interval  $i_x$  of length  $l_x$  which is entirely within some  $\sigma$ . The length  $l_x$  is in general different for different points,  $x$ . Our theorem states that a value  $l$  can be found which is effective as an  $l_x$  for every  $x$ , i.e., uniformly over the interval  $\overline{a b}$ . The distinction here drawn is one of the most important in rigorous analysis. It was first observed in connection with the theorem of uniform continuity; see page 70.

The presence of both end points of  $\overline{a b}$  is essential, as is shown by the following example.  $\overline{0 1}$  is covered by the segments  $\overline{\frac{1}{2} 2}, \overline{\frac{1}{4} 1}, \overline{\frac{1}{8} \frac{1}{2}}, \dots, \overline{\frac{1}{2^n} \frac{1}{2^{n-2}}}, \dots$ , but as we take points nearer to 0,  $l_x$  becomes smaller with the lower bound 0, and no  $l$  can be found which is effective for all points of  $\overline{0 1}$ . When the end points are absent it is possible, however, to modify the notion of covering, so that our theorem remains true. This is sufficiently indicated by the following theorem, which is an immediate consequence of Theorem 10.

**Theorem 13.** If on a segment  $\overline{a b}$  there exists any set  $[\sigma]$  of segments such that

- (1)  $[\sigma]$  includes a segment of which  $a$  is an end point and a segment of which  $b$  is an end point.
- (2) Every point of the segment  $\overline{a b}$  lies on one or more of the segments of the set  $[\sigma]$ .

Then among the segments of the set  $[\sigma]$  there exists a finite set of segments  $\sigma_1, \sigma_2, \dots, \sigma_n$  which satisfies conditions (1) and (2).

The theorems which we have just proved can be generalized to space of any number of dimensions. A planar generalization of a segment is a parallelogram with sides parallel to the coordinate axes, the boundary being excluded. The planar generalization of an interval is the same with the boundary included. The theorem of BOREL becomes:

**Theorem 14.** If every point of the interior or boundary of a parallelogram  $P$  is interior to at least one parallelogram  $p$  of a set of parallelograms  $[p]$ , then every point of  $P$  is interior to at least one parallelogram of a finite subset  $p_1 \dots p_n$  of  $[p]$ .

**Proof.** Let  $x = 0$ ,  $x = a > 0$ ,  $y = 0$ ,  $y = b > 0$  determine the boundary of  $P$ . Let  $0 \leq y_1 \leq b$ . Upon the interval  $i$  of the line  $y = y_1$ , cut off by  $P$ , those parallelograms of  $[p]$  that include points of  $i$  as interior points determine a set of segments  $[\pi]$  such that every point of  $i$  is an interior point of one of these segments  $\pi$ . There is by Theorem 10 a finite subset of  $[\pi]$ ,  $\pi_1 \dots \pi_n$ , including every point of  $i$ , and therefore a finite subset  $p_1 \dots p_n$  of  $[p]$ , including as interior points every point of  $i$ . Moreover, since the number of  $p_1 \dots p_n$  is finite, they include in their interior all the points of a definite strip, e.g., the points between the lines  $y = y_1 - e$  and  $y = y_1 + e$ .

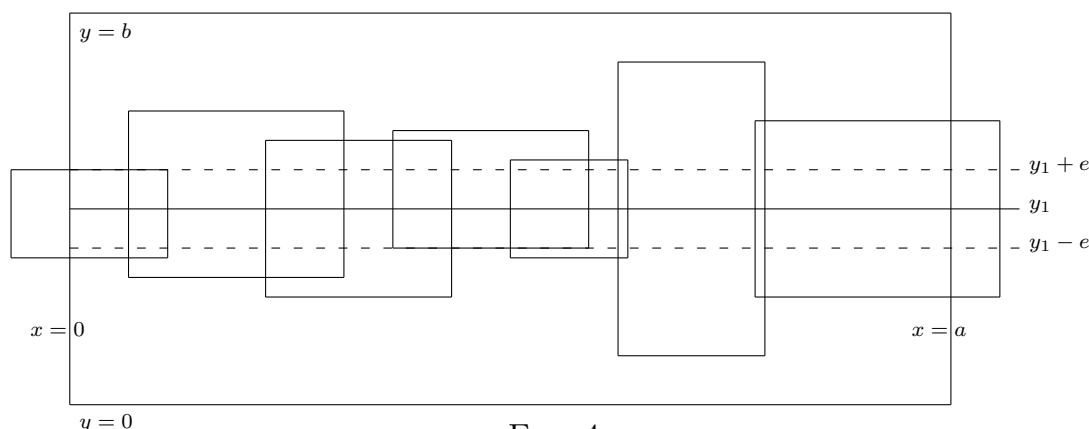

FIG. 4.

Thus for every  $y_1$  ( $0 \leq y_1 \leq b$ ) we obtain a strip of the parallelogram  $P$  such that every point of its interior is interior to one of a finite number of the parallelograms  $[p]$ . These strips intersect the  $y$ -axis in a set of segments that include every point of the interval  $0 \overline{b}$ . There is therefore, by Theorem 10, a finite set of strips which includes every point in  $P$ . Since each strip is included by a finite number of parallelograms  $p$ , the whole parallelogram  $P$  is included by a finite subset of  $[p]$ .

The generalization of Theorems 11 and 12 is left to the reader.

### § 3 Limit Points. Theorem of Weierstrass.

**Definition.**—A *neighborhood* or *vicinity* of a point  $a$  in a line (or simply a line neighborhood of  $a$ ) is a segment of this line such that  $a$  lies within the segment. We denote a line neighborhood of a point  $a$  by  $V(a)$ . The symbol  $V^*(a)$  denotes the set of all points of  $V(a)$  except  $a$  itself. The symbols  $V(\infty)$  and  $V^*(\infty)$  are both used to denote infinite segments  $\overline{a + \infty}$ , and  $V(-\infty)$  and  $V^*(-\infty)$  to denote infinite segments  $\overline{-\infty a}$ .<sup>5</sup>

<sup>5</sup>This notation is taken from PIERPONT'S *Theory of Functions of Real Variables*. It is used here, however, with a meaning slightly different from that of PIERPONT.

A neighborhood of a point in a plane (or a plane neighborhood of a point) is the interior of a parallelogram within which the point lies. A neighborhood of a point  $(a, b)$  is denoted by  $V(a, b)$  if  $(a, b)$  is included and by  $V^*(a, b)$  if  $(a, b)$  is excluded. Instead of the three linear vicinities  $V(a)$ ,  $V(\infty)$ , and  $V(-\infty)$  we have the following nine in the case of the plane:

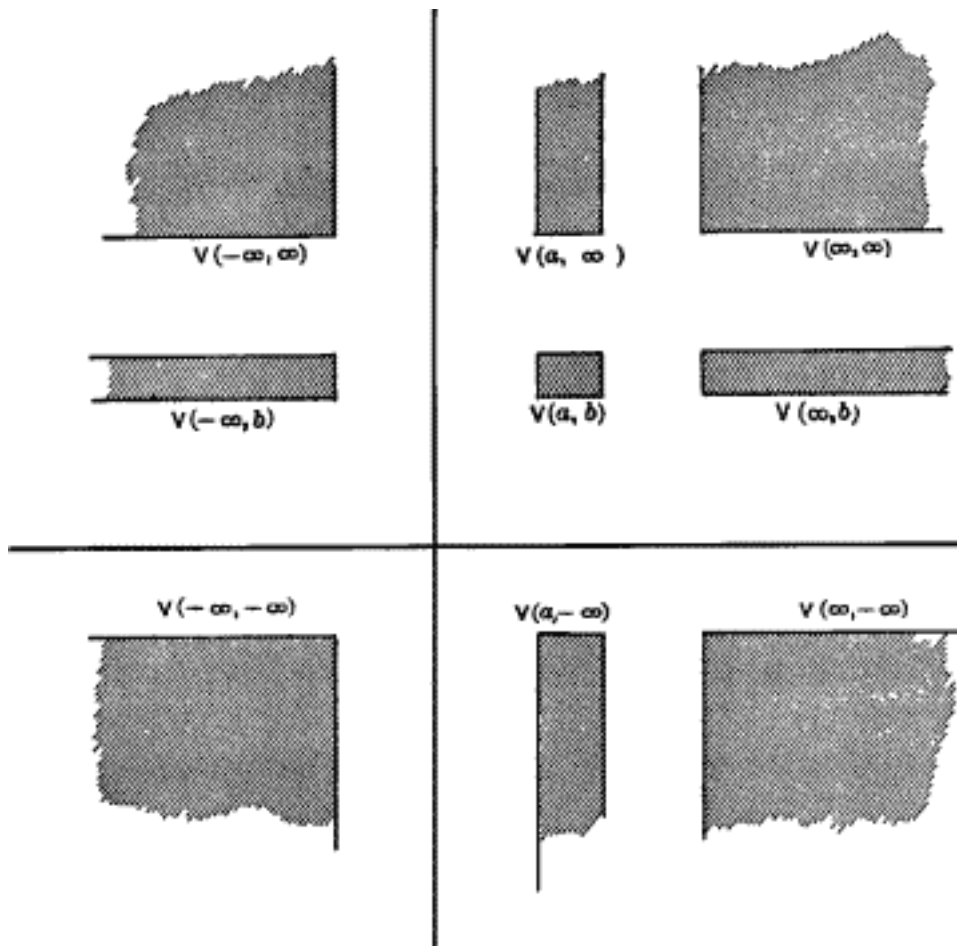

FIG. 5.

It follows at once from a consideration of the scheme for setting the points on the line into correspondence with all numbers that in every neighborhood of a point there is a point whose corresponding number is rational.

**Definition.**—A point  $a$  is said to be a *limit point* of a set if there are points of the set, other than  $a$ , in every neighborhood of  $a$ . In case of a line neighborhood this says that there are points of the set in every  $V^*(a)$ . In the planar case this is equivalent to saying that  $(a, b)$  is a limit point of the set  $[x, y]$ , either if for every  $V^*(a)$  and  $V(b)$  there is an  $(x, y)$  of which  $x$  is in  $V^*(a)$  and  $y$  in  $V(b)$ , or if for every  $V(a)$  and  $V^*(b)$  there is an  $(x, y)$  of which  $x$  is in  $V(a)$  and  $y$  in  $V^*(b)$ .

Thus 0 is a limit point of the set  $[\frac{1}{2^k}]$ , where  $k$  takes all positive integral values. In this case the limit point is not a point of the set. On the other hand, in the set  $1, 1 - \frac{1}{2}, 1 - \frac{1}{2^2}, \dots, 1 - \frac{1}{2^k}, 1$  is a limit point of the set and also a point of the set. In this case 1 is the least upper bound of the set. In case of the set 1, 2, 3, the number 3 is the least upper bound without being a limit point. The fundamental theorem about limit points is the following (due to WEIERSTRASS):

**Theorem 15.** *Every infinite bounded set  $[p]$  of points on a line has at least one limit point.*

**Proof.** Since the set  $[p]$  is bounded, every one of its points lies on a certain interval  $\overline{a b}$ . If the set  $[p]$  has no limit point, then about every point of the interval  $\overline{a b}$  there is a segment  $\sigma$  which contains not more than one point of the set  $[p]$ . By Theorem 10 there is a finite set of the segments  $[\sigma]$  such that every point of  $\overline{a b}$  and hence of  $[p]$  belongs to at least one of them, but each  $\sigma$  contains at most one point of the set  $[p]$ , whence  $[p]$  is a finite set of points. Since this is contrary to the hypothesis, the assumption that there is no limit point is not tenable.

It is customary to say that a set which has no finite upper bound has the upper bound  $+\infty$ , and that one which has no finite lower bound has the lower bound  $-\infty$ . In these cases, since the set has a point in every  $V^*(+\infty)$  or in every  $V^*(-\infty)$   $+\infty$  and  $-\infty$  are also called limit points. With these conventions the theorem may be stated as follows:

**Theorem 16.** *Every infinite set of points has a limit point, finite or infinite.*

The theorem also generalizes in space of any number of dimensions. In the planar case we have:

**Theorem 17.** *An infinite set of points lying entirely within a parallelogram has at least one limit point.*

Theorem 17 is a corollary of the stronger theorem that follows:

**Theorem 18.** *If  $[(x, y)]$  is any set of number pairs and if  $a$  is a limit point of the numbers  $[x]$ , there is a value of  $b$ , finite or  $+\infty$  or  $-\infty$ , such that for every  $V^*(a)$  and  $V(b)$  there is an  $(x, y)$  of which  $x$  is in  $V^*(a)$  and  $y$  is in  $V(b)$ .*

**Proof.** Suppose there is no value  $b$  finite or  $+\infty$  or  $-\infty$  such as is required by the theorem. Since neither  $+\infty$  nor  $-\infty$  possesses the property required of  $b$ , there is a  $\overline{V^*(a)}$  and a  $V(\infty)$  and a  $V(-\infty)$  such that for every pair  $(x, y)$  of  $[(x, y)]$  whose  $x$  lies in  $\overline{V^*(a)}$   $y$  fails to lie in either  $V(\infty)$  or  $V(-\infty)$ . This means that there exists a pair of numbers  $M$  and  $m$  such that for every  $(x, y)$  whose  $x$  is in  $\overline{V^*(a)}$  the  $y$  satisfies the condition  $m < y < M$ . Further, since there exists no  $b$  such as is required by the theorem, there is for every number  $k$  on the interval  $\overline{m M}$  a  $V(k)$  and a  $V_k^*(a)$ , such that for no  $(x, y)$  is  $x$  in  $V_k^*(a)$  and  $y$  in



$V(k)$ . This set of segments  $[V(k)]$  covers the interval  $\overline{m M}$ , whence by Theorem 10 there is a finite subset of  $[V(k)]$ ,  $V_1(k), \dots, V_n(k)$  which covers  $\overline{m M}$ , and hence a finite set of corresponding  $V_k^*(a)$ 's. Let  $\overline{V^*}(a)$  be a vicinity of  $a$  contained in every one of the finite set of  $V_k^*(a)$ 's and in  $\overline{V^*}(a)$ . Hence if the  $x$  of a pair  $(x, y)$  is in  $\overline{V^*}(a)$ , its  $y$  cannot lie in one of the infinite segments  $\overline{M \infty}$  and  $\overline{-\infty m}$ , or in one of the finite segments  $V_1(k), \dots, V_n(k)$ , i.e., no  $y$  corresponds to this  $x$ , which is contrary to the hypothesis. This argument covers the cases when  $a$  is  $+\infty$  and when  $a$  is  $-\infty$ .

We add the definitions of a few of the technical terms that are used in point-set theory.<sup>6</sup>

**Definition.**—A set of points which includes all its limit points is called a *closed* set.

A set of points every one of which is a limit point of the set is called *dense in itself*.<sup>7</sup>

A set of points which is both *closed* and *dense in itself* is called *perfect*.

A set having no finite limit point is called *discrete*.

A segment not including its end points is an example of a set *dense in itself* but not *closed*. If the end points are added, the set is *closed* and therefore *perfect*. The set of rational numbers is another case of a set *dense in itself* but not *closed*. Any set containing only a finite number of points is *closed*, according to our definition.

If every point of an interval  $\overline{a b}$  is a limit point of a set  $[x]$ , then  $[x]$  is *everywhere dense* on  $\overline{a b}$ . Such a set has a point between every two points of the interval. A set which is everywhere dense on no interval is called *nowhere dense*. All rational numbers between 0 and 1 form an *everywhere dense* set.

## § 4 Second Proof of Theorem 15.

To make the reader familiar with a style of argument which is frequently used in proving theorems which in this book are made to depend upon Theorems 10 and 14, we adjoin the following lemma and base upon it another proof of Theorem 15.

**Lemma.**—Hypothesis: On a straight line there is an infinite set of intervals  $\overline{a_1 b_1}, \overline{a_2 b_2}, \dots, \overline{a_n b_n}, \dots$  conditioned as follows:<sup>8</sup>

<sup>6</sup>For bibliography and an exposition in English see W. H. YOUNG and G. C. YOUNG, *The Theory of Sets of Points*. Cambridge, The University Press.

<sup>7</sup>In German "in sich dicht."

<sup>8</sup>In particular the set of segments assumed in the hypothesis may be obtained by dividing any given segment into a given number of equal segments, then one of these segments into the same number of equal segments and so on indefinitely. To show that the sequential division into a number of equal segments gives a set of segments satisfying the conditions of the hypothesis we have merely to show that such division gives a segment less than any assigned segment  $\overline{a_e b_e}$ . This is equivalent to the statement that for every number  $e$  there is an integer  $n$ , such that  $\frac{1}{n} < e$  a direct consequence of Theorem 3. This involves the notion that

- (1) Interval  $\overline{a_2 b_2}$  lies on interval  $\overline{a_1 b_1}$ ,  $\overline{a_3 b_3}$  on  $\overline{a_2 b_2}$ , etc. In general  $\overline{a_n b_n}$  lies on  $\overline{a_{n-1} b_{n-1}}$ . (This does not exclude the case  $a_k = a_{k+1}$ .)
- (2) For every length  $e > 0$ , however small, there is some  $n$ , say  $n_e$ , such that  $|b_{n_e} - a_{n_e}| < e$ .

Conclusion: There is one and only one point  $b$  which lies upon every interval  $\overline{a_n b_n}$ .

**Proof.** Since the set of points  $a_1 \dots a_n \dots$  is bounded, we have at once, by the postulate of continuity, that this set has a leftmost right bound  $\overline{B}_a$ . Similarly, the set  $b_1 \dots b_n \dots$  has a rightmost left bound  $\underline{B}_b$ . It follows at once that  $\overline{B}_a = \underline{B}_b$ , for if not, we get either an  $a$  point to the right of  $\overline{B}_a$ , or a  $b$  point to the left of  $\underline{B}_b$  when  $n_e$  is so chosen that  $|b_{n_e} - a_{n_e}| < \overline{B}_a - \underline{B}_b$ .

We now give another proof for Theorem 11. Divide the interval  $\overline{a b}$  on which all points of  $[p]$  lie into two equal intervals. Then there is an infinite number of points  $[p]$  on at least one of these intervals which we call  $\overline{a_1 b_1}$ . Divide this interval into two equal parts and so on indefinitely, always selecting for division an interval which contains an infinite number of points of the set  $[p]$ . We thus obtain an infinite sequence of intervals  $\overline{a_1 b_1}$ ,  $\overline{a_2 b_2}$ , ...,  $\overline{a_n b_n} \dots$  which satisfies the hypothesis of the lemma. There is therefore a point  $B$  which belongs to every one of the intervals  $\overline{a_1 b_1}$ ,  $\overline{a_2 b_2}$ , ...,  $\overline{a_n b_n} \dots$ , and therefore there is a point of the set  $[p]$  in every neighborhood of  $B$ .

It should be noticed that the intervals in this sequence may be such that all intervals after a certain one will have, say, the right extremities in common. In this case the right extremity is the point  $B$ . Such is the sequence, obtained by decimal division, representing the number  $2 = 1.99999 \dots$

---

no constant infinitesimal exists. It may appear at first sight that a proof of this statement is superfluous. The fact is, however, as was first proved by VERONESE, that the non-existence of constant infinitesimals is not provable without some axiom such as the continuity axiom or the so-called Archimedean Axiom.

## Chapter 3

# FUNCTIONS IN GENERAL. SPECIAL CLASSES OF FUNCTIONS.

### § 1 Definition of a Function.

**Definition.**—A *variable* is a symbol which represents any one of a set of numbers. A *constant* is a special case of a variable where the set consists of but one number.

**Definition.**—A variable  $y$  is said to be a *single-valued function* of another variable  $x$  if to every value of  $x$  there corresponds one and only one value of  $y$ . The letter  $x$  is called the *independent* variable and  $y$  the *dependent* variable.<sup>1</sup>

**Definition.**—A variable  $y$  is said to be a many-valued function or multiple-valued function of another variable  $x$  if to every value of  $x$  there correspond one or more values of  $y$ . The class of multiple-valued functions thus includes the class of single-valued functions.<sup>1</sup>

---

<sup>1</sup>This definition of function is the culmination of a long development of the use of the word. The idea of function arose in connection with coordinate geometry, RENÉ DESCARTES using the word as early as 1637. From this time to that of LEIBNITZ “function” was used synonymously with the word “power,” such as  $x^2$ ,  $x^3$ , etc.

G. W. LEIBNITZ regarded “function” as “any expression standing for certain lengths connected with a curve, such as coordinates, tangents, radii of curvature, normals, etc.”

JOHANN BERNOULLI (1718) defined “function” as “an expression made up of one variable and any constants whatever.”

LEONARD EULER (1734) called the expression described by BERNOULLI an analytic function and introduced the notation  $f(x)$ . EULER also distinguished between algebraic and transcendental functions. He wrote the first treatise on “The Theory of Functions.”

The problem of vibrating strings led to the consideration of trigonometric series. J. B. FOURIER set the problem of determining what kind of relations can be expressed by trigonometric series. The possibility then under consideration that any relation might be so expressed led LEJEUNE DIRICHLET to state his celebrated definition, which is the one given above. See the Encyclopädie der mathematischen Wissenschaften, II A. 1, pp. 3–5; also BALL’s History of Mathematics, p. 378.

It is sometimes convenient to think of special values taken by these two variables as arranged in two tables, one table containing values of the independent variable and the other containing the corresponding values of the dependent variable.

Independent Variable	Dependent Variable
$x_1$	$y_1$
$x_2$	$y_2$
·	·
·	·
·	·
$x_n$	$y_n$

If  $y$  is a single-valued function of  $x$ , one and only one value of  $y$  will appear in the table for each  $x$ . It is evident that functionality is a reciprocal relation; that is, if  $y$  is a function of  $x$ , then  $x$  is a function of  $y$ . It does not follow, however, that if  $y$  is a single-valued function of  $x$ , then  $x$  is a single-valued function of  $y$ , e.g.,  $y = x^2$ . It is also to be noticed that such tables cannot exhibit the functional relation completely when the independent variable takes all values of the continuum, since no table contains all such values.

**Definition.**—That  $y$  is a function of  $x$  (and hence that  $x$  is a function of  $y$ ) is expressed by the equation  $y = f(x)$  or by  $x = f^{-1}(y)$ . If  $y$  and  $x$  are connected by the equation  $y = f(x)$ ,  $f^{-1}(y)$  is called the inverse function of  $f(x)$ .

Thus  $y = x^2$  has the inverse function  $x = \pm\sqrt{y}$ . In this case, while the first function  $y = x^2$  is defined for all real values of  $x$ , the inverse function  $x = \pm\sqrt{y}$  is defined only for positive values of  $y$ .

The independent variable may or may not take all values between any two of its values. Thus  $n!$  is a function of  $n$  where  $n$  takes only integral values.  $S_n$ , the sum of the first  $n$  terms of a series, is a function of  $n$  where  $n$  takes only integral values. Again, the amount of food consumed in a city is a function of the number of people in the city, where the independent variable takes on only integral values. Or the independent variable may take on all values between any two of its values, as in the formula for the distance fallen from rest by a body in time  $t$ ,  $s = \frac{gt^2}{2}$ .

It follows from the correspondence between pairs of numbers and points in a plane that the functional relation between two variables may be represented by a set of points in a plane. The points are so taken that while one of the two numbers which correspond to a point is a value of the independent variable, the other number is the corresponding value, or one of the corresponding values, of the dependent variable. Such representations are called graphs of the function. Cases in point where the function is single-valued are: the hyperbola referred to its asymptotes as axes ( $y = \frac{1}{x}$ ); a straight line not parallel to the  $y$  axis ( $y = ax + b$ ); or a broken line such that no line parallel to the  $y$  axis contains more than one of its points. In general, the graph of a single-valued function with a single-valued inverse is a set of points  $[(x, y)]$  such that no two points have the same  $x$  or the same  $y$ .

Following is a graph of a function where the independent variable does not take all values between any two of its values. Consider  $S_n$ , the sum of the first  $n$  terms as a

function of  $n$  in the series

$$S = 1 + \frac{1}{2} + \frac{1}{2^2} + \dots + \frac{1}{2^{n-1}} + \dots$$

The numbers on the  $x$  axis are the values taken by the independent variable, while the functional relation is represented by the points within the small circles. Thus it is seen that the graph of this function consists of a discrete set of points. (Fig. 6.)

The definition of a function here given is very general. It will permit, for instance, a function such that for all rational values of the independent variable the value of the function is unity, and for irrational values of the independent variable the value of the function is zero.

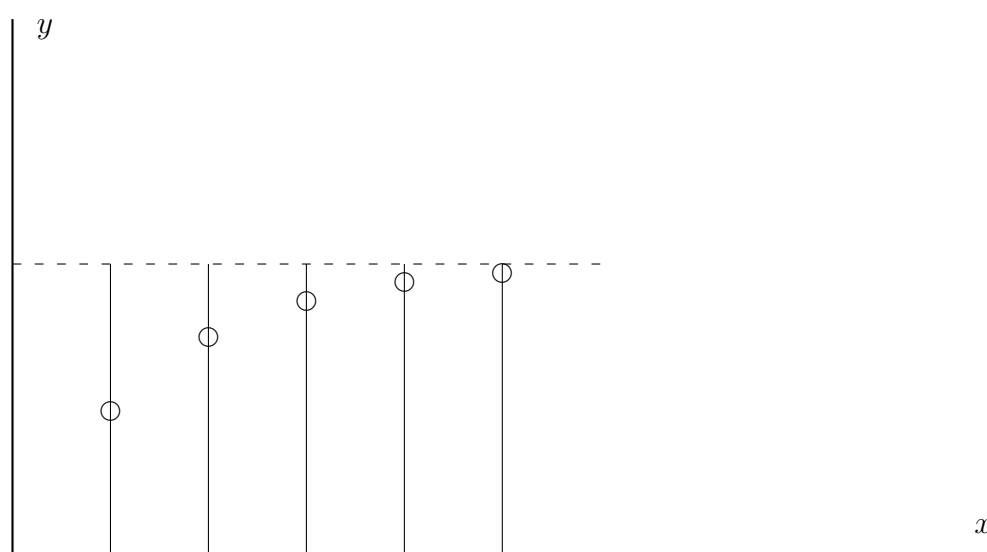

FIG. 6.

## § 2 Bounded Functions.

Since the definition of function is so general there are few theorems that apply to all functions. If the restriction that  $f(x)$  shall be bounded is introduced, we have at once a very important theorem.

**Definition.**—A function,  $f(x)$ , has an *upper bound* for a set of values  $[x]$  of the independent variable if there exists a finite number  $M$  such that  $f(x) < M$  for every value of  $x$  in the set  $[x]$ . The function has a *lower bound*  $m$  if  $f(x) > m$  for every value of  $x$  in  $[x]$ . A function which for a given set of values of  $x$  has no finite upper bound is said to be unbounded on that set, or to have an upper bound  $+\infty$  on that set, and if it has no lower bound on the set the function is said to have the lower bound  $-\infty$  on the set.

**Theorem 19.** If on an interval  $a b$  a function has an upper bound  $M$ , then it has a least upper bound  $\bar{B}$ , and there is at least one value of  $x$ ,  $x_1$  on  $a b$  such that the least upper bound of the function on every neighborhood of  $x_1$  contained in  $a b$  is  $\bar{B}$ .

**Proof.** (1) The set of values of the function  $f(x)$  form a bounded set of numbers. By Theorem 4 the set has a least upper bound  $\bar{B}$ .

(2) Suppose there were no point  $x_1$  on  $a b$  such that the least upper bound on every neighborhood of  $x_1$  contained in  $a b$  is  $\bar{B}$ . Then for every  $x$  of  $a b$  there would be a segment  $\sigma_x$  containing  $x$  such that the least upper bound of  $f(x)$  for values of  $x$  common to  $\sigma_x$  and  $a b$  is less than  $\bar{B}$ . The set  $[\sigma_x]$  is infinite, but by Theorem 10 there exists a finite subset  $[\sigma_n]$  of the set  $[\sigma_x]$  covering  $a b$ . Therefore, since the upper bound of  $f(x)$  is less than  $\bar{B}$  on that part of every one of these segments of  $[\sigma_n]$  which lies on  $a b$ , it follows that the least upper bound of  $f(x)$  on  $a b$  is less than  $\bar{B}$ . Hence the hypothesis that no point  $x_1$  exists is not tenable, and there is a point  $x_1$  such that the least upper bound of the function on every one of its neighborhoods which lies in  $a b$  is  $\bar{B}$ .

This argument applies to multiple-valued as well as to single-valued functions.

As an exercise the reader may repeat the above argument to prove the following:

*Corollary.*—If on an interval  $a b$  a function has an upper bound  $+\infty$ , then there is at least one value of  $x$ ,  $x_1$  on  $a b$  such that in every neighborhood of  $x_1$  the upper bound of the function is  $+\infty$ .

### § 3 Monotonic Functions; Inverse Functions.

**Definitions.**—If a single-valued function  $f(x)$  on an interval  $a b$  is such that  $f(x_1) < f(x_2)$  whenever  $x_1 < x_2$ , the function is said to be *monotonic increasing* on that interval. If  $f(x_1) > f(x_2)$  whenever  $x_1 < x_2$ , the function is said to be *monotonic decreasing*.

If there exist three values of  $x$  on the interval  $a b$ ,  $x_1$ ,  $x_2$ , and  $x_3$  such that  $f(x_2) > f(x_1)$  and  $f(x_2) > f(x_3)$  while  $x_1 < x_2 < x_3$  or  $f(x_2) < f(x_1)$  and  $f(x_2) < f(x_3)$ , while  $x_1 < x_2 < x_3$ , the function is said to be *oscillating* on that interval. A function which is not oscillating on an interval is called *non-oscillating*. It should be noticed that a function is not necessarily oscillating even if it is not monotonic. That is, it may be constant on some parts of the interval.

The terms monotonic and oscillating are not convenient of application to multiple-valued functions. Hence we restrict their use to single-valued functions.

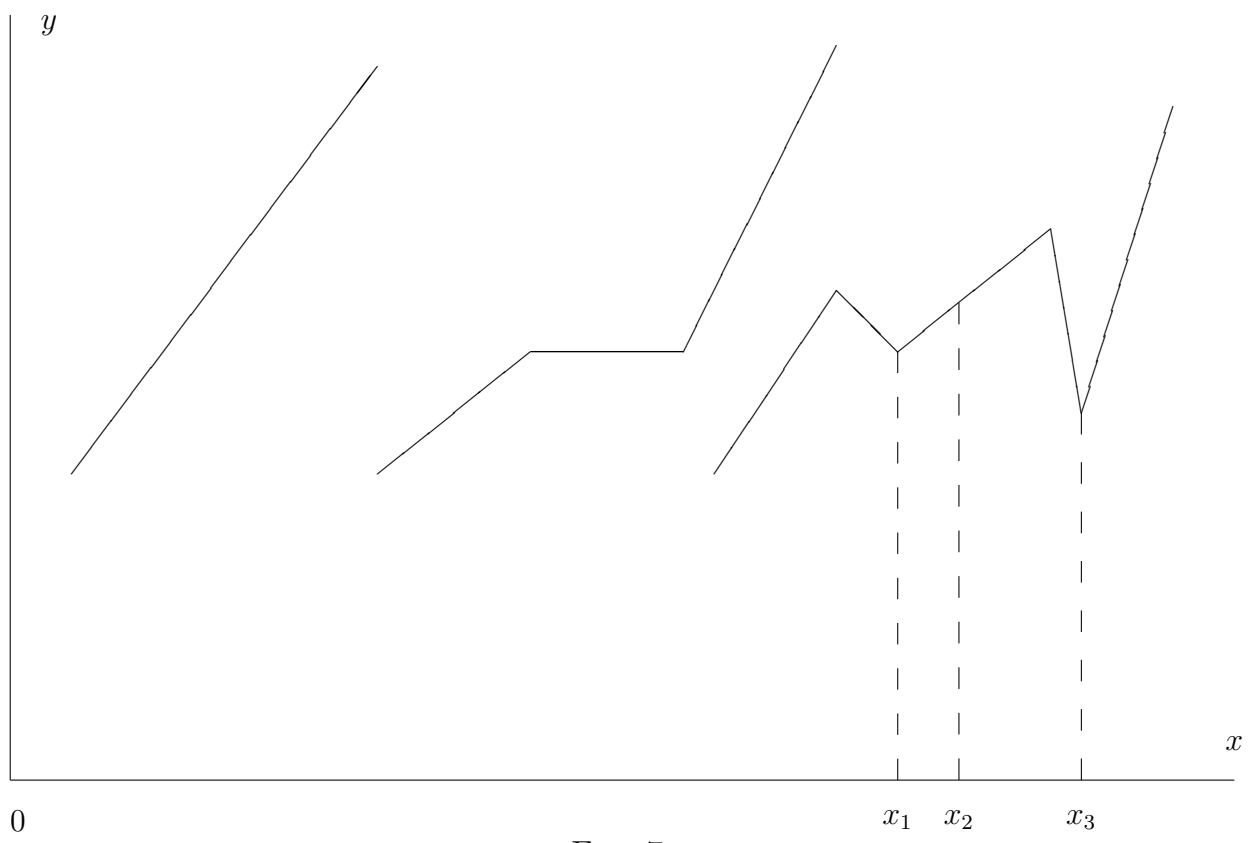

FIG. 7.

**Definition.**—A function  $f(x)$  is said to have a finite number of oscillations on an interval  $|a b|$  if there exists a finite number of points  $a = x_0, x_1, \dots, x_n = b$ , such that on each interval  $|x_{k-1} x_k|$  ( $k = 1, 2, 3, \dots, n$ )  $f(x)$  is non-oscillating. It is evident that if a function has only a finite number of oscillations on an interval  $|a b|$  and if there is no subinterval of  $|a b|$  on which the function is constant, then the interval  $|a b|$  may be subdivided into a finite set of intervals on each of which the function is monotonic. Such a function may be called *partitively monotonic* (Abteilungsweise monoton).

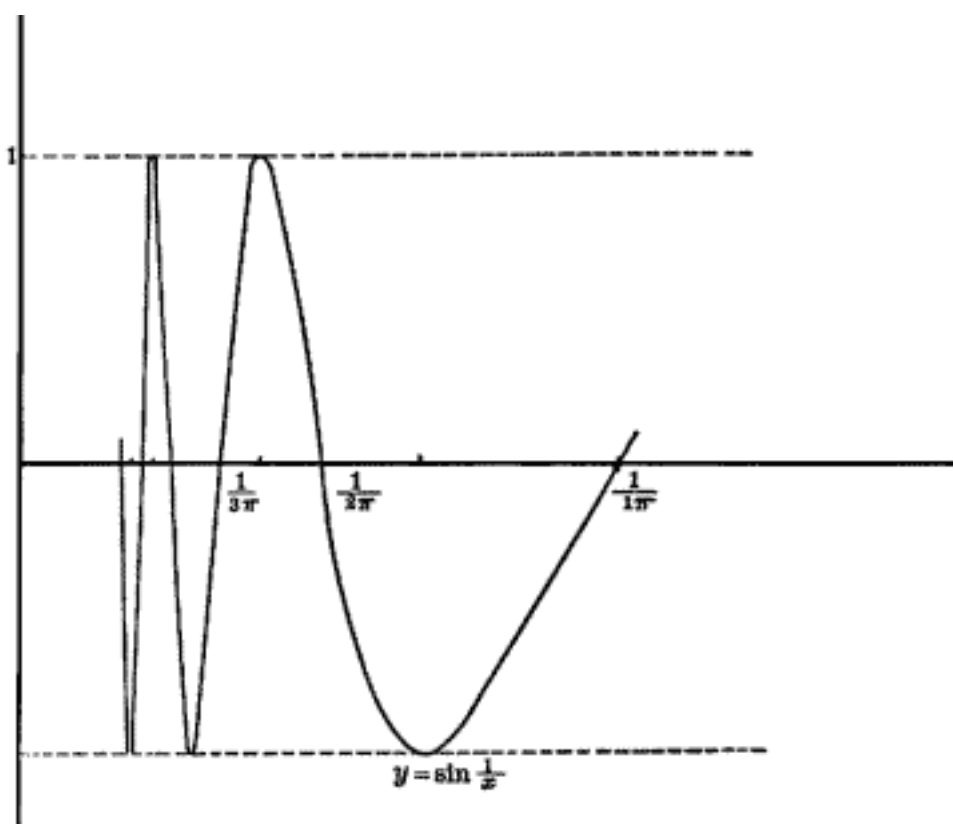

FIG. 8.

The function  $f(x) = \sin \frac{1}{x}$ , for  $x \neq 0$ , and  $f(x) = 0$ , for  $x = 0$ , is an example of a function with an infinite number of oscillations on every neighborhood of a point.  $f(x) = x \sin \frac{1}{x}$ , for  $x \neq 0$ ,  $f(0) = 0$ , and  $f(x) = x^2 \sin \frac{1}{x}$ , for  $x \neq 0$ ,  $f(0) = 0$  have the above property and also are continuous (see page 48 for meaning of the term continuous function).

There exist continuous functions which have an infinite number of oscillations on every neighborhood of every point. The first function of this type is probably the one discovered by Weierstrass,<sup>2</sup> which is continuous over an interval and does not possess a derivative at

<sup>2</sup>According to F. Klein, this function was discovered by Weierstrass in 1851. See KLEIN, *Anwendung*



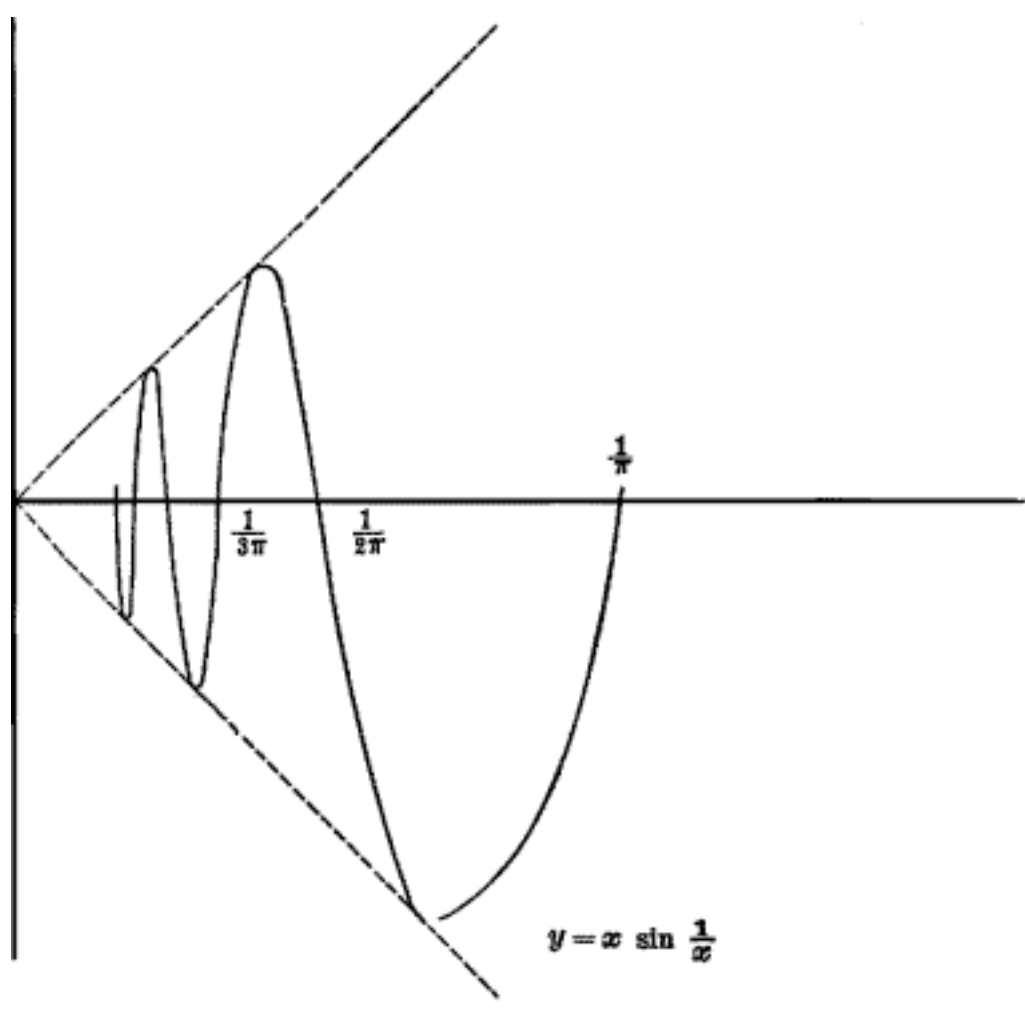

FIG. 9.

any point on this interval (see page 120). Other functions of this type have been published by PEANO, MOORE, and others.<sup>3</sup> These latter investigators have obtained the function in question in connection with space-filling curves.

**Theorem 20.** If  $y$  is a monotonic function of  $x$  on the interval  $\overline{a b}$ , with bounds  $A$  and  $B$ , then in turn  $x$  is a single-valued monotonic function of  $y$  on  $\overline{A B}$ , whose upper and lower bounds are  $b$  and  $a$ .

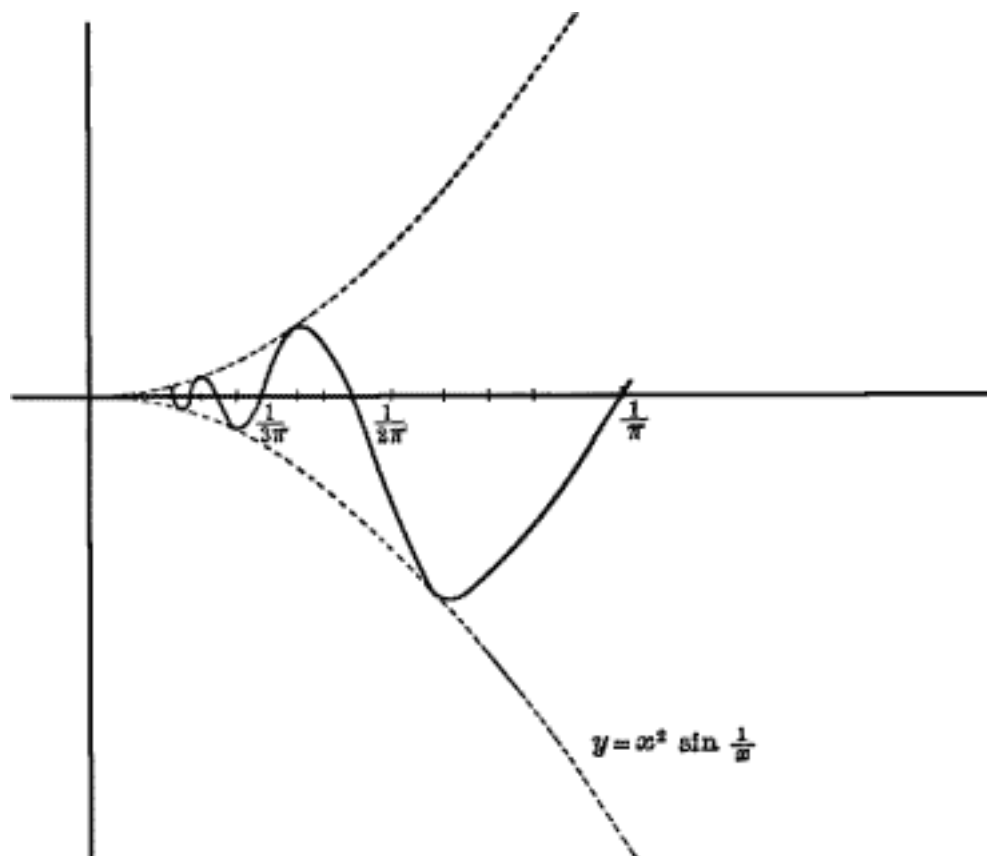

FIG. 10.

**Proof.** It follows from the monotonic character of  $y$  as a function of  $x$  that for no two values of  $x$  does  $y$  have the same value. Hence for every value of  $y$  on  $\overline{A B}$  there exists

*der Differential- und Integralrechnung auf Geometrie*, p. 83 et seq. The function was first published in a paper entitled *Abhandlungen aus der Functionenlehre*, DU BOIS REYMOND, *Crelle's Journal*, Vol. 79, p. 29 (1874).

<sup>3</sup>G. PEANO, *Sur une courbe, qui remplit toute une aire plane*, *Mathematische Annalen*, Vol. 36, pp. 157–160 (1890). CESARO, *Sur la représentation analytique des régions et des courbes qui les remplissent*, *Bulletin des Sciences Mathématiques*, 2d Ser., Vol. 21, pp. 257–267. E. H. MOORE, *On Certain Crinkly Curves*, *Transactions of the American Mathematical Society*, Vol. 1, pp. 73–90 (1899). See also STEINITZ, *Mathematische Annalen*, Vol. 52, pp. 58–69 (1899).

one and only one value of  $x$ . That is,  $x$  is a single-valued function of  $y$ .<sup>4</sup> Moreover, it is clear that for any three values of  $y$ ,  $y_1$ ,  $y_2$ ,  $y_3$ , such that  $y_2$  is between  $y_1$  and  $y_3$ , the corresponding values of  $x$ ,  $x_1$ ,  $x_2$ ,  $x_3$ , are such that  $x_2$  is between  $x_1$  and  $x_3$ , i.e.,  $x$  is a monotonic function of  $y$ , which completes the proof of the theorem.

*Corollary.*—If a function  $f(x)$  has a finite number  $k$  of oscillations and is constant on no interval, then its inverse is at most  $(k + 1)$ -valued. For example, the inverse of  $y = x^2$  is double-valued.

## § 4 Rational, Exponential, and Logarithmic Functions.

**Definitions.**—The symbol  $a^m$ , where  $m$  is a positive integer and  $a$  any real number whatever, means the product of  $m$  factors  $a$ . This definition gives a meaning to the symbol

$$y = a_mx^m + a_{m-1}x^{m-1} + \dots + a_1x + a_0,$$

where  $a_0 \dots a_m$  are any real numbers and  $m$  any positive integer. In this case  $y$  is called a rational integral function of  $x$  or a polynomial in  $x$ .<sup>5</sup>

In case

$$y = \frac{a_mx^m + a_{m-1}x^{m-1} + \dots + a_1 \cdot x + a_0}{b_nx^n + b_{n-1}x^{n-1} + \dots + b_1 \cdot x + b_0},$$

$m$  and  $n$  being positive integers and  $a_k$  ( $k = 0, \dots, m$ ) and  $b_l$  ( $l = 0, \dots, n$ ) being real numbers,  $y$  is called a rational function of  $x$ .

If

$$y^n + y^{n-1}R_1(x) + y^{n-2}R_2(x) + \dots + yR_{n-1}(x) + R_n(x) = 0,$$

where  $R_1(x) \dots R_n(x)$  are rational functions of  $x$ , then  $y$  is said to be an algebraic function of  $x$ . Any function which is not algebraic is transcendental.

The symbol  $a^x$ , where  $x = \frac{m}{n}$ ,  $m$  and  $n$  being positive integers and  $a$  any positive real number, is defined to be the  $n$ th root of the  $m$ th power of  $a$ . By elementary algebra it is easily shown that

$$a^{x_1} \cdot a^{x_2} = a^{x_1+x_2} \quad \text{and} \quad (a^{x_1})^{x_2} = a^{x_1 \cdot x_2}.$$

If

$$y = a^x,$$

then  $y$  is an *exponential* function of  $x$ . At present this function is defined only for rational values of  $x$ .

<sup>4</sup>It is clear that the independent variable  $y$  of the inverse function may not take on all values of a continuum even if  $x$  does take on all such values.

<sup>5</sup>The notion of polynomial finds its natural generalization in that of a power series

$$y = c_0 + c \cdot x + c_2 \cdot x^2 + \dots + c_n x^n + \dots$$

For conditions under which a series defines  $y$  as a function of  $x$  see Chapter IV, § 3.

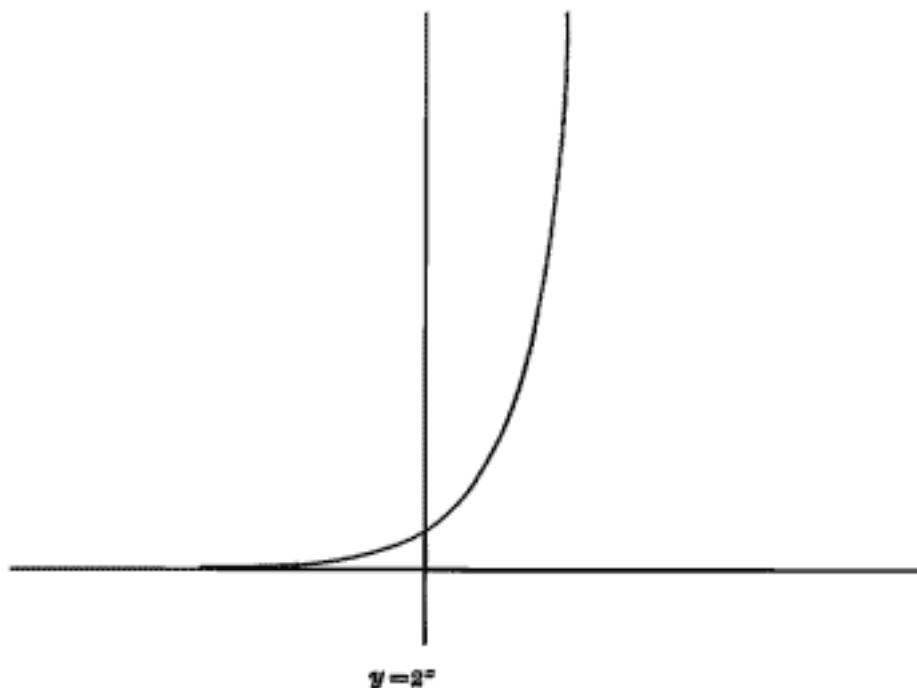

FIG. 11.

**Theorem 21.** *The function  $a^x$  for  $x$  on the set  $\left[\frac{m}{n}\right]$  is a monotonic increasing function if  $1 < a$ , and a monotonic decreasing function if  $0 < a < 1$ .*

**Proof.** (a) For integral values of  $x$  the theorem is obvious.

(b) If  $x_1 = \frac{m_1}{n_1}$  and  $x_2 = \frac{m_2}{n_1}$ , where  $\frac{m_2}{n_1} > \frac{m_1}{n_1}$ , then  $a^{x_1} < a^{x_2}$  if  $a > 1$  and  $a^{x_1} > a^{x_2}$  if  $a < 1$ . The proof of this follows at once from case (a), since  $a^{\frac{m_1}{n_1}} = \left(a^{\frac{1}{n_1}}\right)^{m_1}$  (by definition and elementary algebra) and  $a^{\frac{m_2}{n_1}} = \left(a^{\frac{1}{n_1}}\right)^{m_2}$ .

(c) If  $x_1 = \frac{m_1}{n_1}$  and  $x_2 = \frac{m_2}{n_2}$ , where  $\frac{m_1}{n_1} < \frac{m_2}{n_2}$ , we have  $a^{\frac{m_1}{n_1}} = a^{\frac{m_1 \cdot n_2}{n_1 \cdot n_2}}$  and  $a^{\frac{m_2}{n_2}} = a^{\frac{m_2 \cdot n_1}{n_2 \cdot n_1}}$ , where  $m_1 \cdot n_2 < m_2 \cdot n_1$ , which reduces case (c) to case (b).

This theorem makes it natural to define  $a^x$ , where  $a > 1$  and  $x$  is a positive irrational number, as the least upper bound of all numbers of the form  $\left[a^{\frac{m}{n}}\right]$ , where  $\left[\frac{m}{n}\right]$  is the set of all positive rational numbers less than  $x$ , i.e.,  $a^x = \overline{B}\left[a^{\frac{m}{n}}\right]$ . It is, however, equally natural to define  $a^x$  as  $\underline{B}\left[a^{\frac{p}{q}}\right]$ , where  $\left[\frac{p}{q}\right]$  is the set of all rational numbers greater than  $x$ . We shall prove that the two definitions are equivalent.

**Lemma.**—*If  $[x]$  is the set of all positive rational numbers, then*

$$\underline{B}[a^x] = 1 \quad \text{if } a > 1$$

and

$$\overline{B}[a^x] = 1 \quad \text{if } a < 1.$$

**Proof.** We prove the lemma only for the case  $a > 1$ , the argument in the other case being similar. If  $x$  is any positive rational number,  $\frac{m}{n}$ , then the number  $\frac{1}{n}$  is less than or equal to  $x$ , and since  $a^x$  is a monotonic function,  $a^{\frac{1}{n}} \leq a^{\frac{m}{n}}$ . But  $[\frac{1}{n}]$  is a subset of  $[\frac{1}{n}]$ . Hence

$$\underline{B}[a^x] = \underline{B}\left[a^{\frac{1}{n}}\right],$$

where  $[n]$  is the set of all positive integers.

If  $\underline{B}\left[a^{\frac{1}{n}}\right]$  were less than 1, then there would be a value,  $n_1$ , of  $n$  such that  $a^{\frac{1}{n_1}} < 1$ . This implies that  $a < 1$ , which is contrary to the hypothesis. On the other hand, if  $\underline{B}\left[a^{\frac{1}{n}}\right] > 1$ , there is a number of the form  $1 + e$ , where  $e > 0$ , such that  $1 + e < a^{\frac{1}{n}}$  for every  $n$ . Hence  $(1 + e)^n < a$  for every  $n$ , but by the binomial theorem for integral exponents

$$(1 + e)^n > 1 + ne,$$

and the latter expression is clearly greater than  $a$  if

$$n > \frac{a}{e}.$$

Since  $\underline{B}\left[a^{\frac{1}{n}}\right]$  cannot be either greater or less than 1,

$$\underline{B}\left[a^{\frac{1}{n}}\right] = 1.$$

**Theorem 22.** If  $x$  is any real number, and  $[\frac{m}{n}]$  the set of all rational numbers less than  $x$ , and  $[\frac{p}{q}]$  the set of all rational numbers greater than  $x$ , then

$$\begin{aligned} \overline{B}\left[a^{\frac{m}{n}}\right] &= \underline{B}\left[a^{\frac{p}{q}}\right] && \text{if } a > 1, \\ \underline{B}\left[a^{\frac{m}{n}}\right] &= \overline{B}\left[a^{\frac{p}{q}}\right] && \text{if } 0 < a < 1. \end{aligned}$$

**Proof.** We give the detailed proof only in the case  $a > 1$ , the other case being similar. By the lemma, since  $\underline{B}\left[\frac{p}{q} - \frac{m}{n}\right]$  is zero,

$$\underline{B}\left[a^{\frac{p}{q}} - a^{\frac{m}{n}}\right] = \underline{B}\left[a^{\frac{p}{q}}\left(1 - a^{\frac{m-p}{nq}}\right)\right]$$

is also zero. Now if

$$\overline{B}\left[a^{\frac{m}{n}}\right] \neq \underline{B}\left[a^{\frac{p}{q}}\right],$$

since  $a^{\frac{p}{q}}$  is always greater than  $a^{\frac{m}{n}}$ ,

$$\underline{B} \left[ a^{\frac{p}{q}} \right] - \overline{B} \left[ a^{\frac{m}{n}} \right] = \varepsilon > 0.$$

But from this it would follow that

$$a^{\frac{p}{q}} - a^{\frac{m}{n}}$$

is at least as great as  $\varepsilon$ , whereas we have proved that

$$\underline{B} \left[ a^{\frac{p}{q}} - a^{\frac{m}{n}} \right] = 0.$$

Hence

$$\overline{B} \left[ a^{\frac{m}{n}} \right] = \underline{B} \left[ a^{\frac{p}{q}} \right]$$

if  $a > 1$ .

**Definition.**—In case  $x$  is a positive irrational number, and  $\left[ \frac{p}{q} \right]$  is the set of all rational numbers greater than  $x$ , and  $\left[ \frac{m}{n} \right]$  is the set of all rational numbers less than  $x$ , then

$$a^x = \underline{B} \left[ a^{\frac{p}{q}} \right] = \overline{B} \left[ a^{\frac{m}{n}} \right] \quad \text{if } a > 1$$

and

$$a^x = \overline{B} \left[ a^{\frac{p}{q}} \right] = \underline{B} \left[ a^{\frac{m}{n}} \right] \quad \text{if } 0 < a < 1.$$

Further, if  $x$  is any negative real number, then

$$a^x = \frac{1}{a^{-x}} \quad \text{and} \quad a^0 = 1.$$

**Theorem 23.** *The function  $a^x$  is a monotonic increasing function of  $x$  if  $a > 1$ , and a monotonic decreasing function if  $0 < a < 1$ . In both cases its upper bound is  $+\infty$  and its lower bound is zero, the function taking all values between these bounds; further,*

$$a^{x_1} \cdot a^{x_2} = a^{x_1+x_2} \quad \text{and} \quad (a^{x_1})^{x_2} = a^{x_1 \cdot x_2}.$$

The proof of this theorem is left as an exercise for the reader. The proof is partly contained in the preceding theorems and involves the same kind of argument about upper and lower bounds that is used in proving them.

**Definition.**—The *logarithm* of  $x$  ( $x > 0$ ) to the *base*  $a$  ( $a > 0$ ) is a number  $y$  such that  $a^y = x$ , or  $a^{\log_a x} = x$ . That is, the function  $\log_a x$  is the inverse of  $a^x$ . The identity

$$a^{x_1} \cdot a^{x_2} = a^{x_1+x_2}$$

gives at once

$$\log_a x_1 + \log_a x_2 = \log_a (x_1 \cdot x_2),$$

and

$$(a^{x_1})^{x_2} = a^{x_1 \cdot x_2} \quad \text{gives} \quad x_1 \cdot \log_a x_2 = \log_a x_2^{x_1}.$$

By means of Theorem 20, the logarithm  $\log_a x$ , being the inverse of a monotonic function, is also a monotonic function, increasing if  $1 < a$  and decreasing if  $0 < a < 1$ . Further, the function has the upper bound  $+\infty$  and the lower bound  $-\infty$ , and takes on all real values as  $x$  varies from 0 to  $+\infty$ . Thus it follows that for  $x < a$ ,  $1 < b$ ,

$$\overline{B}(\log_b x) = \log_b a = \log_b(\overline{B}x).$$

By means of this relation it is easy to show that the function

$$x^a, \quad (x > 0)$$

is monotonic increasing for all values of  $a$ ,  $a > 0$ , that its lower bound is zero and its upper bound is  $+\infty$ , and that it takes on all values between these bounds.

The proof of these statements is left to the reader. The general type of the argument required is exemplified in the following, by means of which we infer some of the properties of the function  $x^x$ .

If  $x_1 < x_2$ , then

$$\log_2 x_1 < \log_2 x_2,$$

and

$$x_1 \cdot \log_2 x_1 < x_2 \cdot \log_2 x_2,$$

and

$$\begin{aligned} \log_2 x_1^{x_1} &< \log_2 x_2^{x_2}. \\ \therefore x_1^{x_1} &< x_2^{x_2}. \end{aligned}$$

Hence  $x^x$ , ( $x > 0$ ) is a monotonic increasing function of  $x$ . Since the upper bound of  $x \cdot \log_2 x = \log_2 x^x$  is  $+\infty$ , the upper bound of  $x^x$  is  $+\infty$ . The lower bound of  $x^x$  is not negative, since  $x > 0$ , and must not be greater than the lower bound of  $2^x$ , since if  $x < 2$ ,  $x^x < 2^x$ ; since the lower bound of  $2^x$  is zero<sup>6</sup> the lower bound of  $x^x$  must also be zero.

Further theorems about these functions are to be found on pages 51, 63, 76, 97, and 129.

---

<sup>6</sup>The lower bound of  $a^x$  is zero by Theorem 23.





# Chapter 4

## THEORY OF LIMITS.

### § 1 Definitions. Limits of Monotonic Functions.

**Definition.**—If a point  $a$  is a limit point of a set of values taken by a variable  $x$ , the variable is said *to approach  $a$  upon* the set; we denote this by the symbol  $x \doteq a$ .  $a$  may be finite or  $+\infty$  or  $-\infty$ .

In particular the variable may approach  $a$  from the left or from the right, or in the case where  $a$  is finite, the variable may take values on each side of the limit point. Even when the variable takes all values in some neighborhood on each side of the limit point it may be important to consider it first as taking the values on one side and then those on the other.

**Definition.**—A value  $b$  ( $b$  may be  $+\infty$  or  $-\infty$  or a finite number) is a *value approached* by  $f(x)$  as  $x$  approaches  $a$  if for every  $V^*(a)$  and  $V(b)$  there is at least one value of  $x$  such that  $x$  is in  $V^*(a)$  and  $f(x)$  in  $V(b)$ . Under these conditions  $f(x)$  is also said to approach  $b$  as  $x$  approaches  $a$ .

**Definition.**—If  $b$  is the only value approached as  $x$  approaches  $a$ , then  $b$  is called *the limit of  $f(x)$  as  $x$  approaches  $a$* . This is also indicated by the phrase “ $f(x)$  converges to a unique limit  $b$  as  $x$  approaches  $a$ ,” or “ $f(x)$  approaches  $b$  as a limit,” or by the notation

$$\lim_{x \doteq a} f(x) = b.$$

The function  $f(x)$  is sometimes referred to as the *limitand*. The set of values taken by  $x$  is sometimes indicated by the symbol for a limit, as, for example,

$$\lim_{\substack{x > a \\ x \doteq a}} f(x) = b \quad \text{or} \quad \lim_{\substack{x < a \\ x \doteq a}} f(x) = b \quad \text{or} \quad \lim_{\substack{x \in [x] \\ x \doteq a}} f(x) = b.$$

The first means that  $x$  approaches  $a$  from the right, the second that  $x$  approaches  $a$  from the left, and the third indicates that the approach is over some set  $[x]$  otherwise defined.

**Definition.**—If  $f(x)$  is single-valued and converges to a finite limit as  $x$  approaches  $a$  and

$$\lim_{x \rightarrow a} f(x) = f(a),$$

then  $f(x)$  is said to be *continuous* at  $x = a$ .

By reference to § 3, Chapter II, the reader will see that if  $b$  is a value approached by  $f(x)$  as  $x$  approaches  $a$ , then  $(a, b)$  is a limit point of the set of points  $(x, f(x))$ . Theorem 18 therefore translates into the following important statement:

**Theorem 24.** *If  $f(x)$  is any function defined for any set  $[x]$  of which  $a$  is a (finite or  $+\infty$  or  $-\infty$ ) limit point, then there is at least one value (finite or  $+\infty$  or  $-\infty$ ) approached by  $f(x)$  as  $x$  approaches  $a$ .*

*Corollary.*—If  $f(x)$  is a bounded function, the values approached by  $f(x)$  are all finite.

In the light of this theorem we see that the existence of

$$\lim_{x \rightarrow a} f(x)$$

simply means that  $f(x)$  approaches only one value, while the non-existence of

$$\lim_{x \rightarrow a} f(x)$$

means that  $f(x)$  approaches at least two values as  $x$  approaches  $a$ .

In case  $f(x)$  is monotonic (and hence single-valued), or more generally if  $f(x)$  is a non-oscillating function, these ideas are particularly simple. We have in fact the theorem:

**Theorem 25.** *If  $f(x)$  is a non-oscillating function for a set of values  $[x] < a$ ,  $a$  being a limit point of  $[x]$ , then as  $x$  approaches  $a$  from the left on the set  $[x]$ ,  $f(x)$  approaches one and only one value  $b$ , and if  $f(x)$  is an increasing function,*

$$b = \overline{B}f(x)$$

for  $x$  on  $[x]$ , whereas if  $f(x)$  is a decreasing function,

$$b = \underline{B}f(x)$$

for  $x$  on  $[x]$ .

**Proof.** Consider an increasing non-oscillating function and let

$$b = \overline{B}f(x)$$

for  $x$  on  $[x]$ .

In view of the preceding theorem we need to prove only that no value  $b' \neq b$  can be a value approached. Suppose  $b' > b$ ; then since  $\overline{B}f(x) = b$ , there would be no value of  $f(x)$  between  $b$  and  $b'$ , that is, there would be a  $V(b')$  which could contain no value of  $f(x)$ , whence  $b' > b$  is not a value approached. Suppose  $b' < b$ . Then take  $b' < b'' < b$ , and since  $\overline{B}f(x) = b$ , there would be a value  $x_1$  of  $[x]$  such that  $f(x_1) > b''$ . If  $x_1 < x < a$ , then  $b'' < f(x_1) \leq f(x)$ , because  $f(x)$  cannot decrease as  $x$  increases. This defines a  $V^*(a)$  and a  $V(b')$  such that if  $x$  is in  $V^*(a)$ ,  $f(x)$  cannot be in  $V(b')$ . Hence  $b' < b$  is not a value approached. A like argument applies if  $f(x)$  is a decreasing function, and of course the same theorem holds if  $x$  approaches  $a$  from the right.

It does not follow that

$$\underset{x \dot{=} a}{L_{x < a}} f(x) = \underset{x \dot{=} a}{L_{x > a}} f(x),$$

nor that either of these limits is equal to  $f(a)$ . A case in point is the following: Let the temperature of a cooling body of water be the independent variable, and the amount of heat given out in cooling from a certain fixed temperature be the dependent variable. When the water reaches the freezing-point a great amount of heat is given off without any change in temperature. If the zero temperature is approached from below, the function approaches a definite limit point  $k$ , and if the temperature approaches zero from above, the function approaches an entirely different point  $k'$ . This function, however, is multiple-valued at the

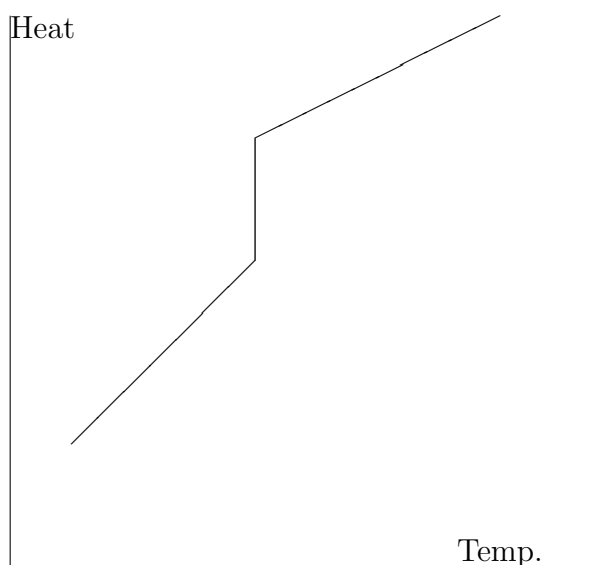

FIG. 12

zero point. A case where the limit fails to exist is the following: The function  $y = \sin 1/x$ ; (see Fig. 8, page 38) approaches an infinite number of values as  $x$  approaches zero. The value of the function will be alternately 1 and  $-1$ , as  $x = \frac{2}{\pi}, \frac{2}{3\pi}, \frac{2}{5\pi}$  etc., and for all values of  $x$  between any two of these the function will take all values between 1 and  $-1$ . Clearly

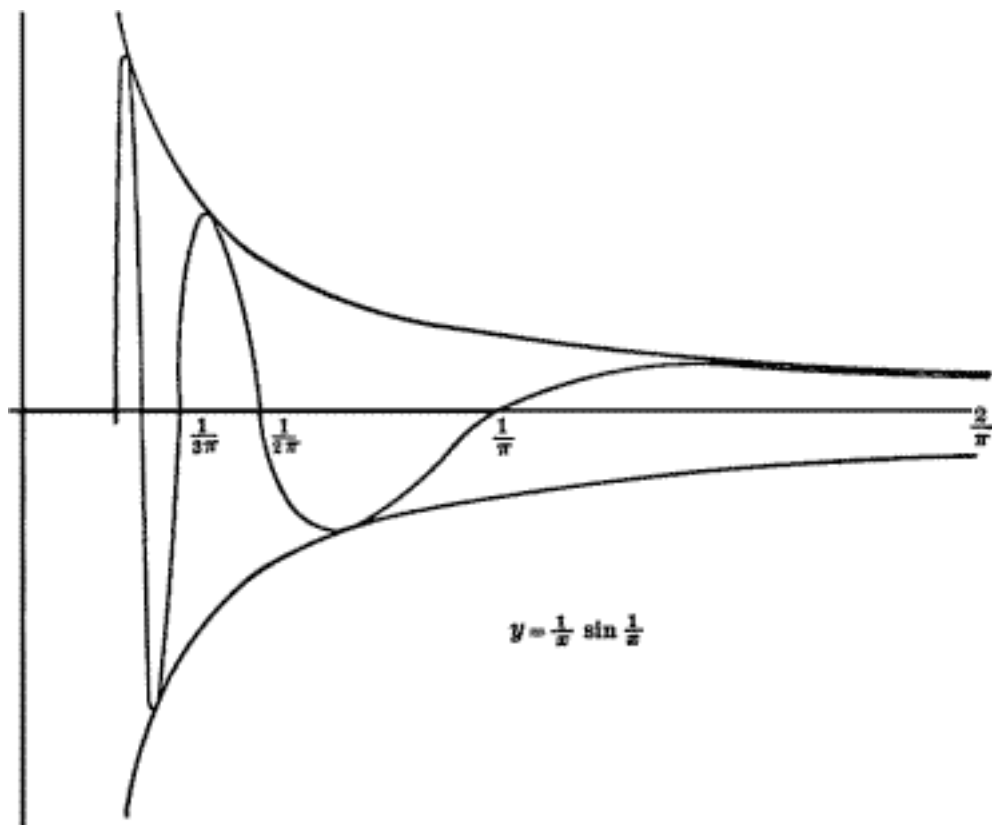

FIG. 13.

every value between 1 and  $-1$  is a value approached as  $x$  approaches zero. In like manner  $y = \frac{1}{x} \sin \frac{1}{x}$  approaches all values between and including  $+\infty$  and  $-\infty$ , cf. Fig. 13.

The functions  $a^x$ ,  $\log_a x$ ,  $x^a$  defined in § 4 of the last chapter are all monotonic and all satisfy the condition that

$$\lim_{\substack{x > a \\ x \rightarrow a}} f(x) = f(a) = \lim_{\substack{x < a \\ x \rightarrow a}} f(x)$$

at all points where the functions are defined. These functions are therefore all continuous.

## § 2 The Existence of Limits.

**Theorem 26.** *A necessary and sufficient condition<sup>1</sup> that  $f(x)$  shall converge to a unique limit  $b$  as  $x$  approaches  $a$ , i.e., that*

$$\lim_{x \rightarrow a} f(x) = b,$$

*is that for every  $V(b)$  there shall exist a  $V^*(a)$  such that for every  $x$  in  $V^*(a)$ ,  $f(x)$  is in  $V(b)$ .*

**Proof.** (1) *The condition is necessary.* It is to be proved that if  $\lim_{x \rightarrow a} f(x) = b$ , then for every  $V(b)$  there exists a  $V^*(a)$  such that for every  $x$  in  $V^*(a)$  the corresponding  $f(x)$  is in  $V(b)$ . If this conclusion did not follow, then for some  $V(b)$  every  $V^*(a)$  would contain at least one  $x'$  such that  $f(x')$  is not in  $V(b)$ . There is thus defined a set of points  $[x']$  of which  $a$  is a limit point. By Theorem 20  $f(x)$  would approach at least one value  $b'$  as  $x$  approaches  $a$  on the set  $[x']$ . But by the definition of  $[x']$ ,  $b'$  is distinct from  $b$ . Hence the hypothesis would be contradicted.

(2) *The condition is sufficient.* We need only to show that if for every  $V(b)$  there exists a  $V^*(a)$  such that for every  $x$  in  $V^*(a)$  the corresponding  $f(x)$  is in  $V(b)$ , then  $f(x)$  can approach no other value than  $b$ . If  $b' \neq b$ , then there exists a  $\bar{V}(b')$  and a  $\bar{V}(b)$  which have no point in common. Now if  $\bar{V}^*(a)$  is such that for every  $x$  of  $\bar{V}^*(a)$ ,  $f(x)$  is in  $\bar{V}(b)$ , then for no such  $x$  is  $f(x)$  in  $\bar{V}(b')$  and hence  $b'$  is not a value approached.

The reader should observe that this proof applies also to multiple-valued functions, although worded to fit the single-valued case. It is worthy of note that in case  $b$  is a finite number, our theorem becomes:

---

<sup>1</sup>This means:

- (a) If  $\lim_{x \rightarrow a} f(x) = b$ , then for every  $V(b)$  there exists a  $V^*(a)$ , as specified by the theorem.
- (b) If for every  $V(b)$  there exists a  $V^*(a)$  as specified, then  $\lim_{x \rightarrow a} f(x) = b$ .

A condition is necessary for a certain conclusion if it can be deduced from that conclusion; a condition sufficient for a conclusion is one from which the conclusion can be deduced. A man sufficient for a task is a man who can perform the task, while a man necessary for the task is such that the task cannot be performed without him.

A necessary and sufficient condition that

$$\lim_{x \rightarrow a} f(x) = b$$

is that for every  $\varepsilon > 0$  there exists a  $V_\varepsilon^*(a)$  such that for every  $x$  in  $V_\varepsilon^*(a)$ ,  $|f(x) - b| < \varepsilon$ .

In case  $a$  also is finite, the condition may be stated in a form which is frequently used as the definition of a limit, namely:

$\lim_{x \rightarrow a} f(x) = b$  means that for every  $\varepsilon > 0$  there exists a  $\delta_\varepsilon > 0$  such that if  $|x - a| < \delta_\varepsilon$  and  $x \neq a$ , then  $|f(x) - b| < \varepsilon$ .<sup>2</sup>

**Theorem 27.** A necessary and sufficient condition that  $f(x)$  shall converge to a finite limit as  $x$  approaches  $a$  is that for every  $\varepsilon > 0$  there shall exist a  $V_\varepsilon^*(a)$  such that if  $x_1$  and  $x_2$  are any two values of  $x$  in  $V_\varepsilon^*(a)$ , then

$$|f(x_1) - f(x_2)| < \varepsilon.$$

**Proof.** (1) *The condition is necessary.* If  $\lim_{x \rightarrow a} f(x) = b$  and  $b$  is finite, then by the preceding theorem for every  $\frac{\varepsilon}{2} > 0$  there exists a  $V^*(a)$  such that if  $x_1$  and  $x_2$  are in  $V^*(a)$ , then

$$|f(x_1) - b| < \frac{\varepsilon}{2}$$

and

$$|f(x_2) - b| < \frac{\varepsilon}{2},$$

from which it follows that

$$|f(x_1) - f(x_2)| < \varepsilon.$$

(2) *The condition is sufficient.* If the condition is satisfied, there exists a  $\overline{V^*}(a)$  upon which the function  $f(x)$  is bounded. For let  $\overline{\varepsilon}$  be some fixed number. By hypothesis there exists a  $\overline{V^*}(a)$  such that if  $x$  and  $x_0$  are on  $\overline{V^*}(a)$ , then

$$|f(x) - f(x_0)| < \overline{\varepsilon}.$$

Taking  $x_0$  as a fixed number, we have that

$$f(x_0) - \overline{\varepsilon} < f(x) < f(x_0) + \overline{\varepsilon}$$

for every  $x$  on  $\overline{V^*}(a)$ . Hence there is at least one *finite* value,  $b$ , approached by  $f(x)$ . Now for every  $\varepsilon > 0$  there exists a  $V_\varepsilon^*(a)$  such that if  $x_1$  and  $x_2$  are any two values of  $x$  in  $V_\varepsilon^*(a)$ ,

<sup>2</sup>The  $\varepsilon$  subscript to  $\delta_\varepsilon$  or to  $V_\varepsilon^*(a)$  denotes that  $\delta_\varepsilon$  or  $V_\varepsilon^*(a)$  is a function of  $\varepsilon$ . It is to be noted that inasmuch as any number less than  $\delta_\varepsilon$  is effective as  $\delta_\varepsilon$ ,  $\delta_\varepsilon$  is a multiple-valued function of  $\varepsilon$ .

$|f(x_1) - f(x_2)| < \varepsilon$ . Hence by the definition of value approached there is an  $x_\varepsilon$  of  $V_\varepsilon^*(a)$  for which

$$|f(x_\varepsilon) - b| < \varepsilon \quad (a)$$

and

$$|f(x_\varepsilon) - f(x)| < \varepsilon \quad (b)$$

for every  $x$  of  $V_\varepsilon^*(a)$ . Hence, combining (a) and (b), for every  $x$  of  $V_\varepsilon^*(a)$  we have

$$|f(x) - b| < 2\varepsilon,$$

and hence by the preceding theorem we have

$$\lim_{x \rightarrow a} f(x) = b.$$

In case  $a$  as well as  $b$  is finite, Theorem 27 becomes:

*A necessary and sufficient condition that*

$$\lim_{x \rightarrow a} f(x)$$

*shall exist and be finite is that for every  $\varepsilon > 0$  there exists a  $\delta_\varepsilon > 0$  such that*

$$|f(x_1) - f(x_2)| < \varepsilon$$

*for every  $x_1$  and  $x_2$  such that*

$$x_1 \neq a, \quad x_2 \neq a, \quad |x_1 - a| < \delta_\varepsilon, \quad |x_2 - a| < \delta_\varepsilon.$$

In case  $a$  is  $+\infty$  the condition becomes:

*For every  $\varepsilon > 0$  there exists a  $N_\varepsilon > 0$  such that*

$$|f(x_1) - f(x_2)| < \varepsilon$$

*for every  $x_1$  and  $x_2$  such that  $x_1 > N_\varepsilon$ ,  $x_2 > N_\varepsilon$ .*

The necessary and sufficient conditions just derived have the following evident corollaries:

*Corollary 1.* The expression

$$\lim_{x \rightarrow a} f(x) = b,$$

where  $b$  is finite, is equivalent to the expression

$$\lim_{x \rightarrow a} (f(x) - b) = 0,$$

and whether  $b$  is finite or infinite

$$\lim_{x \rightarrow a} f(x) = b \text{ is equivalent to } \lim_{x \rightarrow a} (-f(x)) = -b.$$

*Corollary 2.* The expressions

$$\lim_{x \rightarrow a} f(x) = 0 \text{ and } \lim_{x \rightarrow a} |f(x)| = 0$$

are equivalent.

*Corollary 3.* The expression

$$\lim_{x \rightarrow a} f(x) = b$$

is equivalent to

$$\lim_{y \rightarrow 0} f(y + a) = b,$$

where  $y + a = x$ .

*Corollary 4.* The expression

$$\lim_{\substack{x < a \\ x \rightarrow a}} f(x) = b$$

is equivalent to

$$\lim_{z \rightarrow +\infty} f\left(a + \frac{1}{z}\right) = b,$$

where  $z = \frac{1}{x-a}$ .

The reader should verify these corollaries by writing down the necessary and sufficient condition for the existence of each limit. The following less obvious statement is proved in detail for the case when  $b$  is finite, the case when  $b$  is  $+\infty$  or  $-\infty$  being left to the reader.

*Corollary 5.* If

$$\lim_{x \rightarrow a} f(x) = b,$$

then

$$\lim_{x \rightarrow a} |f(x)| = |b|.$$

**Proof.** By the necessary condition of Theorem 26 for every  $\varepsilon$  there exists a  $V_\varepsilon^*(a)$  such that for every  $x_1$  of  $V_\varepsilon^*(a)$

$$|f(x_1) - b| < \varepsilon.$$

If  $f(x_1)$  and  $b$  are of the same sign, then

$$||f(x_1)| - |b|| = |f(x_1) - b| < \varepsilon,$$

and if  $f(x_1)$  and  $b$  are of opposite sign, then

$$||f(x_1)| - |b|| < |f(x_1) - b| < \varepsilon.$$

Hence, by the sufficient condition of Theorem 26,

$$\lim_{x \rightarrow a} |f(x)|$$

exists and is equal to  $|b|$ .



*Corollary 6.* If a function  $f(x)$  is continuous at  $x = a$ , then  $|f(x)|$  is continuous at  $x = a$ .

It should be noticed that

$$\lim_{x \rightarrow a} |f(x)| = |b|$$

is *not equivalent* to

$$\lim_{x \rightarrow a} f(x) = b.$$

Suppose  $f(x) = +1$  for all rational values of  $x$  and  $f(x) = -1$  for all irrational values of  $x$ . Then  $\lim_{x \rightarrow a} |f(x)| = +1$ , but  $\lim_{x \rightarrow a} f(x)$  does not exist, since both  $+1$  and  $-1$  are values approached by  $f(x)$  as  $x$  approaches any value whatever.

**Definition.**—Any set of numbers which may be written  $[x_n]$ , where

$$\begin{aligned} n &= 0, 1, 2, \dots, \kappa, \\ \text{or} \quad n &= 0, 1, 2, \dots, \kappa, \dots, \end{aligned}$$

is called a *sequence*.

To the corollaries of this section may be added a corollary related to the definition of a limit.

*Corollary 7.* If for every sequence of numbers  $[x_n]$  having  $a$  as a limit point,

$$\lim_{\substack{x \rightarrow a \\ x \in [x_n]}} f(x) = b, \quad \text{then} \quad \lim_{x \rightarrow a} f(x) = b.$$

**Proof.** In case two values  $b$  and  $b_1$  were approached by  $f(x)$  as  $x$  approaches  $a$ , then, as in the first part of the proof of Theorem 26, two sequences could be chosen upon one of which  $f(x)$  approached  $b$  and upon the other of which  $f(x)$  approached  $b_1$ .

### § 3 Application to Infinite Series.

The theory of limits has important applications to infinite series. An *infinite series* is defined as an expression of the form

$$\sum_{k=1}^{\infty} a_k = a_1 + a_2 + a_3 + \dots + a_n + \dots$$

If  $S_n$  is defined as

$$a_1 + \dots + a_n = \sum_{k=1}^n a_k,$$

$n$  being any positive integer, then the sum of the series is defined as

$$\lim_{n \rightarrow \infty} S_n = S$$

if this limit exists.

If the limit exists and is finite, the series is said to be *convergent*. If  $S$  is infinite or if  $S_n$  approaches more than one value as  $n$  approaches infinity, then the series is *divergent*. For example,  $S$  is infinite if

$$\sum_{k=1}^{\infty} a_k = 1 + 1 + 1 + 1 \dots,$$

and  $S_n$  has more than one value approached if

$$\sum_{k=1}^{\infty} a_k = 1 - 1 + 1 - 1 + 1 \dots$$

It is customary to write

$$R_n = S - S_n.$$

A necessary and sufficient condition for the convergence of an infinite series is obtained from Theorem 27.

(1) For every  $\varepsilon > 0$  there exists an integer  $N_\varepsilon$ , such that if  $n > N_\varepsilon$  and  $n' > N_\varepsilon$  then

$$|S_n - S_{n'}| < \varepsilon.$$

This condition immediately translates into the following form:

(2) For every  $\varepsilon > 0$  there exists an integer  $N_\varepsilon$ , such that if  $n > N_\varepsilon$ , then for every  $k$

$$|a_n + a_{n+1} + \dots + a_{n+k}| < \varepsilon.$$

*Corollary.*—If  $\sum_{k=1}^{\infty} a_k$  is a convergent series, then  $\lim_{k \rightarrow \infty} a_k = 0$ .

**Definition.**—A series

$$\sum_{k=0}^{\infty} a_k = a_0 + a_1 + \dots + a_n + \dots$$

is said to be *absolutely convergent* if

$$|a_0| + |a_1| + \dots + |a_n| + \dots$$

is convergent.

Since

$$|a_n + a_{n+1} + \dots + a_{n+k}| < |a_n| + |a_{n+1}| + \dots + |a_{n+k}|,$$

the above criteria give

**Theorem 28.** *A series is convergent if it is absolutely convergent.*

**Theorem 29.** *If  $\sum_{k=0}^{\infty} b_k$  is a convergent series all of whose terms are positive and  $\sum_{k=0}^{\infty} a_k$  is a series such that for every  $k$ ,  $|a_k| \leq b_k$ , then*

$$\sum_{k=0}^{\infty} a_k$$

*is absolutely convergent.*

**Proof.** By hypothesis

$$\sum_{k=0}^n |a_k| \leq \sum_{k=0}^n b_k.$$

Hence

$$\sum_{k=0}^n |a_k|$$

is bounded, and being an increasing function of  $n$ , the series is convergent according to Theorem 25.

This theorem gives a useful method of determining the convergence or divergence of a series, namely, by comparison with a known series. Such a known series is the geometric series

$$a + ar + ar^2 + \dots + ar^n + \dots,$$

where  $0 < r < 1$  and  $a > 0$ . In this series

$$\sum_{k=0}^n ar^k = a \frac{1 - r^{n+1}}{1 - r} < \frac{a}{1 - r},$$

which shows that the series is convergent. Moreover, it can easily be seen to have the sum  $\frac{a}{1-r}$ .

If  $r \geq 1$ , the geometric series is evidently divergent. This result can be used to prove the "ratio-test" for convergence.

**Theorem 30.** *If there exists a number,  $r$ ,  $0 < r < 1$ , such that*

$$\left| \frac{a_n}{a_{n-1}} \right| < r$$

*for every integral value of  $n$ , then the series*

$$a_1 + a_2 + \dots + a_n + \dots \tag{1}$$

*is absolutely convergent. If  $\left| \frac{a_n}{a_{n-1}} \right| \geq 1$  for every  $n$ , the series is divergent.*

**Proof.** The series (1) may be written

$$a_1 + a_1 \frac{a_2}{a_1} + a_1 \frac{a_2}{a_1} \cdot \frac{a_3}{a_2} + \dots + a_1 \frac{a_2}{a_1} \dots \frac{a_n}{a_{n-1}} \quad (2)$$

$\left| \frac{a_n}{a_{n-1}} \right| < r$ , this is numerically less term by term than

$$a_1 + a_1 r + a_1 r^2 + \dots + a_1 r^n + \dots \quad (3)$$

and therefore converges absolutely. If  $\left| \frac{a_n}{a_{n-1}} \right| \geq 1$ ,  $a_n \geq a_1$  for every  $n$ ; hence, by the corollary, page 56, (1) is divergent.

Nothing is said about the case when

$$\left| \frac{a_n}{a_{n-1}} \right| < 1, \quad \text{but} \quad \lim_{n \rightarrow \infty} \left| \frac{a_n}{a_{n-1}} \right| = 1.$$

It is evident that the ratio test need be applied only to terms beyond some fixed term  $a_n$ , since the sum of the first  $n$  terms

$$a_1 + a_2 + \dots + a_n$$

may be regarded as a finite number  $S_n$  and the whole series as

$$S_n + a_{n+1} + a_{n+2} + \dots,$$

i.e., a finite number plus the infinite series

$$a_{n+1} + a_{n+2} + \dots$$

## § 4 Infinitesimals. Computation of Limits.

**Theorem 31.** *A necessary and sufficient condition that*

$$\lim_{x \rightarrow a} f(x) = b$$

*is that for the function  $\varepsilon(x)$  defined by the equation  $f(x) = b + \varepsilon(x)$*

$$\lim_{x \rightarrow a} \varepsilon(x) = 0.$$

**Proof.** Take  $\varepsilon(x) = f(x) - b$  and apply Theorem 26. A special case of this theorem is: *A necessary and sufficient condition for the convergence of a series to a finite value  $b$  is that for every  $\varepsilon > 0$  there exists an integer  $N_\varepsilon$ , such that if  $n > N_\varepsilon$  then  $|R_n| < \varepsilon$ .*

**Definition.**—A function  $f(x)$  such that

$$\lim_{x \rightarrow a} f(x) = 0$$

is called an *infinitesimal* as  $x$  approaches  $a$ .<sup>3</sup>

**Theorem 32.** *The sum, difference, or product of two infinitesimals is an infinitesimal.*

**Proof.** Let the two infinitesimals be  $f_1(x)$  and  $f_2(x)$ . For every  $\varepsilon$ ,  $1 > \varepsilon > 0$ , there exists a  $V_1^*(a)$  for every  $x$  of which

$$|f_1(x)| < \frac{\varepsilon}{2},$$

and a  $V_2^*(a)$  for every  $x$  of which

$$|f_2(x)| < \frac{\varepsilon}{2}.$$

Hence in any  $V^*(a)$  common to  $V_1^*(a)$  and  $V_2^*(a)$

$$|f_1(x) + f_2(x)| \leq |f_1(x)| + |f_2(x)| < \varepsilon,$$

$$|f_1(x) - f_2(x)| \leq |f_1(x)| + |f_2(x)| < \varepsilon,$$

$$|f_1(x) \cdot f_2(x)| = |f_1(x)| \cdot |f_2(x)| < \varepsilon.$$

From these inequalities and Theorem 26 the conclusion follows.

**Theorem 33.** *If  $f(x)$  is bounded on a certain  $\overline{V^*}(a)$  and  $\varepsilon(x)$  is an infinitesimal as  $x$  approaches  $a$ , then  $\varepsilon(x) \cdot f(x)$  is also an infinitesimal as  $x$  approaches  $a$ .*

**Proof.** By hypothesis there are two numbers  $m$  and  $M$ , such that  $M > f(x) > m$  for every  $x$  on  $\overline{V^*}(a)$ . Let  $k$  be the larger of  $|m|$  and  $|M|$ . Also by hypothesis there exists for every  $\varepsilon$  a  $V_\varepsilon^*(a)$  within  $\overline{V^*}(a)$  such that if  $x$  is in  $V_\varepsilon^*(a)$ , then

$$|\varepsilon(x)| < \frac{\varepsilon}{k}$$

or

$$k|\varepsilon(x)| < \varepsilon.$$

But for such values of  $x$

$$|f(x) \cdot \varepsilon(x)| < k \cdot |\varepsilon(x)| < \varepsilon,$$

and hence for every  $\varepsilon$  there is a  $V_\varepsilon^*(a)$  such that for  $x$  in  $V_\varepsilon^*(a)$

$$|f(x) \cdot \varepsilon(x)| < \varepsilon.$$

---

<sup>3</sup>No constant, however small if not zero, is an infinitesimal, the essence of the latter being that it varies so as to approach zero as a limit. Cf. Goursat, Cours d'Analyse, tome I, p. 21, etc.

*Corollary.*—If  $f(x)$  is an infinitesimal and  $c$  any constant, then  $c \cdot f(x)$  is an infinitesimal.

**Theorem 34.** *If  $L_{x \dot{=} a} f_1(x) = b_1$  and  $L_{x \dot{=} a} f_2(x) = b_2$ ,  $b_1$  and  $b_2$  being finite, then*

$$L_{x \dot{=} a} \{f_1(x) \pm f_2(x)\} = b_1 \pm b_2, \quad (\alpha)$$

$$L_{x \dot{=} a} \{f_1(x) \cdot f_2(x)\} = b_1 \cdot b_2; \quad (\beta)$$

and if  $b_2 \neq 0$ ,

$$L_{x \dot{=} a} \frac{f_1(x)}{f_2(x)} = \frac{b_1}{b_2} \quad (\gamma)$$

**Proof.** According to Theorem 31, we write

$$\begin{aligned} f_1(x) &= b_1 + \varepsilon_1(x), \\ f_2(x) &= b_2 + \varepsilon_2(x), \end{aligned}$$

where  $\varepsilon_1(x)$  and  $\varepsilon_2(x)$  are infinitesimals. Hence

$$f_1(x) + f_2(x) = b_1 + b_2 + \varepsilon_1(x) + \varepsilon_2(x), \quad (\alpha')$$

$$f_1(x) \cdot f_2(x) = b_1 \cdot b_2 + b_1 \cdot \varepsilon_2(x) + b_2 \cdot \varepsilon_1(x) + \varepsilon_1(x) \cdot \varepsilon_2(x). \quad (\beta')$$

But by the preceding theorem the terms of  $(\alpha')$  and  $(\beta')$  which involve  $\varepsilon_1(x)$  and  $\varepsilon_2(x)$  are infinitesimals, and hence the conclusions  $(\alpha)$  and  $(\beta)$  are established.

To establish  $(\gamma)$ , observe that by Theorem 26 there exists a  $V^*(a)$  for every  $x$  of which  $|f_2(x) - b_2| < |b_2|$  and hence upon which  $f_2(x) \neq 0$ . Hence

$$\frac{f_1(x)}{f_2(x)} = \frac{b_1 + \varepsilon_1(x)}{b_2 + \varepsilon_2(x)} = \frac{b_1}{b_2} + \frac{b_2\varepsilon_1(x) - b_1\varepsilon_2(x)}{b_2\{b_2 + \varepsilon_2(x)\}},$$

the second term of which is infinitesimal according to Theorems 32 and 33.

Some of the cases in which  $b_1$  and  $b_2$  are  $\pm\infty$  are covered by the following theorems. The other cases ( $\infty - \infty$ ,  $\frac{\infty}{\infty}$ ,  $\frac{0}{0}$ , etc.), are treated in Chapter VI.

**Theorem 35.** *If  $f_2(x)$  has a lower bound on some  $V^*(a)$ , and if*

$$L_{x \dot{=} 0} f_1(x) = +\infty,$$

then

$$L_{x \dot{=} 0} \{f_2(x) + f_1(x)\} = +\infty.$$

**Proof.** Let  $M$  be the lower bound of  $f_2(x)$ . By hypothesis, for every number  $E$  there exists a  $V_E^*(a)$  such that for  $x$  on  $V_E^*(a)$

$$f_1(x) > E - M.$$

Since

$$f_2(x) > M,$$

this gives

$$f_1(x) + f_2(x) > E,$$

which means that  $f_1(x) + f_2(x)$  approaches the limit  $+\infty$ .

**Theorem 36.** If  $\lim_{x \rightarrow a} f_1(x) = +\infty$  or  $-\infty$ , and if  $f_2(x)$  is such that for a  $\bar{V}^*(a)$ ,  $f_2(x)$  has a lower bound greater than zero or an upper bound less than zero, then  $\lim_{x \rightarrow a} \{f_1(x) \cdot f_2(x)\}$  is definitely infinite; i.e., if  $f_2(x)$  has a lower bound greater than zero and  $\lim_{x \rightarrow a} f_1(x) = +\infty$ , then  $\lim_{x \rightarrow a} \{f_1(x) \cdot f_2(x)\} = +\infty$ , etc.

**Proof.** Suppose  $f_2(x)$  has a lower bound greater than zero, say  $M$ , and that  $\lim_{x \rightarrow a} f_1(x) = +\infty$ . Then for every  $E$  there exists a  $V_E^*(a)$  within  $\bar{V}^*(a)$  such that for every  $x_1$  of  $V_E^*(a)$ ,  $f_1(x_1) > \frac{E}{M}$ , and therefore  $f_1(x_1) \cdot f_2(x_1) > f_1(x_1) \cdot M > E$ . Hence by the definition of limit of a function  $\lim_{x \rightarrow a} \{f_1(x) \cdot f_2(x)\} = +\infty$ . If we consider the case where  $f_2(x)$  has an upper bound less than zero, we have in the same manner  $\lim_{x \rightarrow a} \{f_1(x) \cdot f_2(x)\} = -\infty$ . Similar statements hold for the cases in which  $\lim_{x \rightarrow a} f_1(x) = -\infty$ .

*Corollary.*—If  $f_2(x)$  is positive and has a finite upper bound and  $\lim_{x \rightarrow a} f_1(x) = +\infty$ , then

$$\lim_{x \rightarrow a} \frac{f_1(x)}{f_2(x)} = +\infty.$$

**Theorem 37.** If  $\lim_{x \rightarrow a} f(x) = +\infty$ , then  $\lim_{x \rightarrow a} \frac{1}{f(x)} = 0$ , and there is a vicinity  $V^*(a)$  upon which  $f(x) > 0$ . Conversely, if  $\lim_{x \rightarrow a} f(x) = 0$  and there is a  $V^*(a)$  upon which  $f(x) > 0$ , then  $\lim_{x \rightarrow a} \frac{1}{f(x)} = +\infty$ .

**Proof.** If  $\lim_{x \rightarrow a} f(x) = +\infty$ , then for every  $\varepsilon$  there exists a  $V_\varepsilon^*(a)$  such that if  $x$  is in  $V_\varepsilon^*(a)$ , then

$$f(x) > \frac{1}{\varepsilon}$$

and

$$\frac{1}{f(x)} < \varepsilon.$$

$$\therefore L_{x \dot{=} a} \frac{1}{f(x)} = 0,$$

since both  $f(x)$  and  $\frac{1}{f(x)}$  are positive.

Again, if  $L_{x \dot{=} a} f(x) = 0$ , then for every  $\varepsilon$  there is a  $\overline{V_\varepsilon^*}(a)$  such that for  $x$  in  $\overline{V_\varepsilon^*}(a)$ ,  $|f(x)| < \varepsilon$  or  $\frac{1}{f(x)} > \frac{1}{\varepsilon}$  ( $f(x)$  being positive). Hence

$$L_{x \dot{=} a} \frac{1}{f(x)} = +\infty.$$

*Corollary 1.* If  $f_1(x)$  has finite upper and lower bounds on some  $V^*(a)$  and  $L_{x \dot{=} a} f_2(x) = +\infty$  or  $-\infty$ , then

$$L_{x \dot{=} a} \frac{f_1(x)}{f_2(x)} = 0.$$

*Corollary 2.* If  $f_2(x)$  is positive and  $f_1(x)$  has a positive lower bound on some  $V^*(a)$  and  $L_{x \dot{=} a} f_2(x) = 0$ , then

$$L_{x \dot{=} a} \frac{f_1(x)}{f_2(x)} = +\infty.$$

**Theorem 38.** (change of variable). *If*

(1)  $L_{x \dot{=} a} f_1(x) = b_1$  and  $L_{x \dot{=} b_1} f_2(y) = b_2$  when  $y$  takes all values of  $f_1(x)$  corresponding to values of  $x$  on some  $\overline{V^*}(a)$ , and if

(2)  $f_1(x) \neq b_1$  for  $x$  on  $\overline{V^*}(a)$ ,

then

$$L_{x \dot{=} a} f_2(f_1(x)) = b_2.$$

**Proof.** ( $\alpha$ ) Since  $L_{y \dot{=} b_1} f_2(y) = b_2$ , for every  $V(b_2)$  there exists a  $V^*(b_1)$  such that if  $y$  is in  $V^*(b_1)$ ,  $f_2(y)$  is in  $V(b_2)$ . Since  $L_{x \dot{=} a} f_1(x) = b_1$ , for every  $V(b_1)$  there exists a  $V^*(a)$  in  $\overline{V^*}(a)$  such that if  $x$  is in  $V^*(a)$ ,  $f_1(x)$  is in  $V(b_1)$ . But by (2) if  $x$  is in  $V^*(a)$ ,  $f_1(x) \neq b_1$ . Hence ( $\beta$ ) for every  $V^*(b_1)$  there exists a  $V^*(a)$  such that for every  $x$  in  $V^*(a)$ ,  $f_1(x)$  is in  $V^*(b_1)$ .

Combining statements ( $\alpha$ ) and ( $\beta$ ): for every  $V(b_2)$  there exists a  $V^*(a)$  such that for every  $x$  in  $V^*(a)$   $f_1(x)$  is in  $V^*(b_1)$ , and hence  $f_2(f_1(x))$  is in  $V(b_2)$ . This means, according to Theorem 26, that

$$L_{x \dot{=} a} f_2(f_1(x)) = b_2.$$



**Theorem 39.** If  $\lim_{x \rightarrow a} f_1(x) = b$  and  $\lim_{y \rightarrow b} f_2(y) = f_2(b)$ , where  $y$  takes all values taken by  $f_1(x)$  for  $x$  on some  $\overline{V^*}(a)$ , then

$$\lim_{x \rightarrow a} f_2(f_1(x)) = f_2(b).$$

**Proof.** The proof of the theorem is similar to that of Theorem 38. In this case the notation  $f_2(b)$  implies that  $b$  is a finite number. Thus for every  $\varepsilon_1$  there exists a  $V_{\varepsilon_1}^*(a)$  entirely within  $\overline{V^*}(a)$  such that if  $x$  is in  $V_{\varepsilon_1}^*(a)$ ,

$$|f_1(x) - b| < \varepsilon_1.$$

Furthermore, for every  $\varepsilon_2$  there exists a  $\delta_{\varepsilon_2}$  such that for every  $y$ ,  $y \neq b$ ,  $|y - b| < \delta_{\varepsilon_2}$ ,

$$|f_2(y) - f_2(b)| < \varepsilon_2.$$

But since  $|f_2(y) - f_2(b)| = 0$  when  $y = b$ , this means that for all values of  $y$  (equal or unequal to  $b$ ) such that  $|y - b| < \delta_{\varepsilon_2}$ ,  $|f_2(y) - f_2(b)| < \varepsilon_2$ . Now let  $\varepsilon_1 = \delta_{\varepsilon_2}$ ; then, if  $x$  is in  $V_{\varepsilon_1}^*(a)$ , it follows that  $|f_1(x) - b| < \delta_{\varepsilon_2}$  and therefore that

$$|f_2(f_1(x)) - f_2(b)| < \varepsilon_2.$$

Hence

$$\lim_{x \rightarrow a} f_2(f_1(x)) = f_2(b).$$

*Corollary 1.* If  $f_1(x)$  is continuous at  $x = a$ , and  $f_2(y)$  is continuous at  $y = f_1(a)$ , then  $f_2(f_1(x))$  is continuous at  $x = a$ .

*Corollary 2.* If  $k \neq 0$ ,  $f(x) \geq 0$ , and  $\lim_{x \rightarrow a} f(x) = b$ , then

$$\lim_{x \rightarrow a} (f(x))^k = b^k,$$

under the convention that  $\infty^k = \infty$  if  $k > 0$  and  $\infty^k = 0$  if  $k < 0$ .

*Corollary 3.* If  $c > 0$  and  $f(x) > 0$  and  $b > 0$  and  $\lim_{x \rightarrow a} f(x) = b$ , then

$$\lim_{x \rightarrow a} \log_c f(x) = \log_c b,$$

under the convention that  $\log_c(+\infty) = +\infty$  and  $\log_c 0 = -\infty$ .

The conclusions of the last two corollaries may also be expressed by the equations

$$\lim_{x \rightarrow a} (f(x))^k = \left( \lim_{x \rightarrow a} f(x) \right)^k$$

and

$$\log_c \lim_{x \rightarrow a} f(x) = \lim_{x \rightarrow a} \log_c f(x).$$

*Corollary 4.* If  $\lim_{x \rightarrow a} (f(x))^k$  or  $\lim_{x \rightarrow a} \log_c f(x)$  fails to exist, then  $\lim_{x \rightarrow a} f(x)$  does not exist.

## § 5 Further Theorems on Limits.

**Theorem 40.** If  $f(x) \leq b$  for all values of a set  $[x]$  on a certain  $V^*(a)$ , then every value approached by  $f(x)$  as  $x$  approaches  $a$  is less than or equal to  $b$ . Similarly if  $f(x) \geq b$  for all values of a set  $[x]$  on a certain  $V^*(a)$ , then every value approached by  $f(x)$  as  $x$  approaches  $a$  is greater than or equal to  $b$ .

**Proof.** If  $f(x) \leq b$  on  $V^*(a)$ , then if  $b'$  is any value greater than  $b$ , and  $V(b')$  any vicinity of  $b'$  which does not include  $b$ , there is no value of  $x$  on  $V^*(a)$  for which  $f(x)$  is in  $V(b')$ . Hence  $b'$  is not a value approached. A similar argument holds for the case where  $f(x) \geq b$ .

*Corollary 1.* If  $f(x) \geq 0$  in the neighborhood of  $x = a$ , then if

$$\lim_{x \rightarrow a} f(x) \text{ exist, } \lim_{x \rightarrow a} f(x) \geq 0.$$

*Corollary 2.* If  $f_1(x) \geq f_2(x)$  in the neighborhood of  $x = a$ , then

$$\lim_{x \rightarrow a} f_1(x) \geq \lim_{x \rightarrow a} f_2(x)$$

if both these limits exist.

**Proof.** Apply Corollary 1 to  $f_1(x) - f_2(x)$ .

*Corollary 3.* If  $f_1(x) \geq f_2(x)$  in the neighborhood of  $x = a$ , then the largest value approached by  $f_1(x)$  is greater than or equal to the largest value approached by  $f_2(x)$ .

*Corollary 4.* If  $f_1(x)$  and  $f_2(x)$  are both positive in the neighborhood of  $x = a$ , and if  $f_1(x) \geq f_2(x)$ , then if  $\lim_{x \rightarrow a} f_1(x) = 0$ , it follows that

$$\lim_{x \rightarrow a} f_2(x) = 0.$$

**Theorem 41.** If  $[x']$  is a subset of  $[x]$ ,  $a$  being a limit point of  $[x']$ , and if  $\lim_{x \rightarrow a} f(x)$  exists, then  $\lim_{x' \rightarrow a} f(x')$  exists and

$$\lim_{x \rightarrow a} f(x) = \lim_{x' \rightarrow a} f(x').^4$$

**Proof.** By hypothesis there exists for every  $V(b)$  a  $V^*(a)$  such that for every  $x$  of the set  $[x]$  which is in  $V^*(a)$ ,  $f(x)$  is in  $V(b)$ . Since  $[x']$  is a subset of  $[x]$ , the same  $V^*(a)$  is evidently efficient for  $x$  on  $[x']$ .

In the statement of necessary and sufficient conditions for the existence of a limit we have made use of a certain positive multiple-valued function of  $\varepsilon$  denoted by  $\delta_\varepsilon$ . If a given value is effective as a  $\delta_\varepsilon$ , then every positive value smaller than this is also effective.

<sup>4</sup>The notation  $f(x')$  is used to indicate that  $x$  takes the values of the set  $[x']$ .

**Theorem 42.** For every  $\varepsilon$  for which the set of values of  $\delta_\varepsilon$  has an upper bound there is a greatest  $\delta_\varepsilon$ .

**Proof.** Let  $\overline{B}[\delta_\varepsilon]$  be the least upper bound of the set of values of  $\delta_\varepsilon$ , for a particular  $\varepsilon$ . If  $x$  is such that  $|x - a| < \overline{B}[\delta_\varepsilon]$ , then there is a  $\delta_\varepsilon$  such that  $|x - a| < \delta_\varepsilon$ . But if  $|x - a| < \delta_\varepsilon$ ,  $|f(x) - b| < \varepsilon$ . Hence, if  $|x - a| < \overline{B}[\delta_\varepsilon]$ ,  $|f(x) - b| < \varepsilon$ .

**Theorem 43.** The limit of the least upper bound of a function  $f(x)$  on a variable segment  $\overline{ax}$ ,  $a < x$ , as the end point approaches  $a$ , is the least upper bound of the values approached by the function as  $x$  approaches  $a$  from the right.

**Proof.** Let  $l$  be the least upper bound of the values approached by the function as  $x$  approaches  $a$  from the right, and let  $b(x)$  represent the upper bound of  $f(x)$  for all values of  $x$  on  $\overline{ax}$ . Since  $\overline{B}f(x)$  on the segment  $\overline{ax_1}$  is not greater than  $\overline{B}f(x)$  on a segment  $\overline{ax_2}$  if  $x_1$  lies on  $\overline{ax_2}$ ,  $b(x)$  is a non-oscillating function decreasing as  $x$  decreases. Hence  $\overline{L} b(x)$  exists by Theorem 21; and by Corollary 3, Theorem 40,  $\overline{L} b(x) \geq l$ . If  $\overline{L} b(x) = k > l$ , then there are two vicinities of  $k$ ,  $V_1(k)$  contained in  $V_2(k)$  and  $V_2(k)$  not containing  $l$ . By Theorem 26 a  $V_1^*(a)$  exists such that if  $x$  is in  $V_1^*(a)$ ,  $b(x)$  is in  $V_1(k)$ . Furthermore, by the definition of  $b(x)$ , if  $x_1$  is an arbitrary value of  $x$  on  $V_1^*(a)$ , then there is a value of  $x$  in  $\overline{ax_1}$  such that  $f(x)$  is in  $V(k)$ . Hence  $k$  would be a value approached by  $f(x)$  contrary to the hypothesis  $k > l$ .

## § 6 Bounds of Indetermination. Oscillation.

It is a corollary of Theorem 43 that in the approach to any point  $a$  from the right or from the left the least upper bounds and the greatest lower bounds of the values approached by  $f(x)$  are themselves values approached by  $f(x)$ . The four numbers thus indicated may be denoted by

$$\overline{f(a+0)} = \overline{L}_{x \dot{=} a+0} f(x) = \overleftarrow{L}_{x \dot{=} a} f(x),$$

the least upper bound of the values approached from the right:

$$\overline{f(a-0)} = \overline{L}_{x \dot{=} a-0} f(x) = \overrightarrow{L}_{x \dot{=} a} f(x),$$

the least upper bound of the values approached from the left:

$$\underline{f(a+0)} = \underline{L}_{x \dot{=} a+0} f(x) = \underline{L}_{x \dot{=} a} f(x),$$

the greatest lower bound of the values approached from the right:

$$\underline{f(a-0)} = \underline{L}_{x \dot{=} a-0} f(x) = \underline{L}_{x \dot{=} a} f(x),$$

the greatest lower bound of the values approached from the left.

If all four of these values coincide, there is only one value approached and  $\lim_{x \rightarrow a} f(x)$  exists. If  $\overline{f(a+0)}$  and  $\underline{f(a+0)}$  coincide, this value is denoted by  $f(a+0)$  and is the same as  $\lim_{x \rightarrow a^+} f(x)$ . Similarly if  $\overline{f(a-0)}$  and  $\underline{f(a-0)}$  coincide, their common value,  $\lim_{x \rightarrow a^-} f(x)$ , is denoted by  $f(a-0)$ . The larger of  $\overline{f(a+0)}$  and  $\overline{f(a-0)}$  is denoted by  $\overline{\lim}_{x \rightarrow a} f(x)$ , and is called the upper limit of  $f(x)$  as  $x$  approaches  $a$ . Similarly  $\underline{\lim}_{x \rightarrow a} f(x)$ , the lower limit of  $f(x)$ , is the smaller of  $\underline{f(a+0)}$  and  $\underline{f(a-0)}$ .  $\overline{\lim}_{x \rightarrow a} f(x)$  and  $\underline{\lim}_{x \rightarrow a} f(x)$  are called the bounds of indetermination of  $f(x)$  at  $x = a$  (Unbestimmtheitsgrenzen). See the Encyclopädie der mathematischen Wissenschaften, II 41.

In order that a function shall be continuous at a point  $a$  it is necessary and sufficient that

$$f(a) = \overline{f(a+0)} = \underline{f(a+0)} = \overline{f(a-0)} = \underline{f(a-0)}. \quad (\text{a})$$

The difference between the greatest and the least of these values is called the *oscillation* of the function at the point  $a$ . It is denoted by  $O_a f(x)$ , and according to the theorem above is equivalent to the lower bound of all values of  $O f(x)$ , where

$$O f(x) = \overline{B} f(x) - \underline{B} f(x) \text{ for a segment } V(a).$$

$O_a^b f(x)$  is used for the oscillation of  $f(x)$  on the segment  $\overline{ab}$ . It is sometimes also used for the oscillation of  $f(x)$  on the interval  $\overline{ab}$ . The word oscillation may also be applied to the difference between the upper and lower bounds of the function on a  $V^*(a)$ . Denote this by  $O_{V^*(a)} f(x)$ . The lower bound of these values may be denoted by  $O_a^* f(x)$  and is the difference between the greatest and the least of the four values  $\overline{f(a+0)}$ ,  $\underline{f(a-0)}$ ,  $\underline{f(a+0)}$ ,  $\overline{f(a-0)}$ .

The reader will find it a useful exercise to construct examples and to enumerate the different ways in which a function may be discontinuous, according as  $f(a+0)$  or  $f(a-0)$  exist or do not exist, and according as  $f(a)$  does or does not coincide with any of the values approached by  $f(x)$ . (Compare the reference to the E. d. m. W. given above.) The principal classification used is into *discontinuities of the first kind*, where  $f(a+0)$  and  $f(a-0)$  both exist, and *discontinuities of the second kind*, where not both  $f(a+0)$  and  $f(a-0)$  exist.

**Theorem 44.** *If  $a$  is a limit point of  $[x]$ , then a necessary and sufficient condition that  $b_2$  and  $b_1$  shall be the upper and lower bounds of indetermination of  $f(x)$ , as  $x \rightarrow a$ , is that for every set of four numbers  $a_1, a_2, c_1, c_2$ , such that<sup>5</sup>*

$$a_1 < b_1 < c_1 < c_2 < b_2 < a_2,$$

<sup>5</sup>If  $b_1 = -\infty$ ,  $a_1 = b_1$  replaces  $a_1 < b_1$ . If  $b_2 = +\infty$ ,  $a_2 = b_2$  replaces  $b_2 < a_2$ .

there exists a  $V^*(a)$  such that for every  $x$  on  $V^*(a)$

$$a_1 < f(x) < a_2,$$

and for some  $x', x''$  on  $V^*(a)$

$$f(x') > c_2 \text{ and } f(x'') < c_1.$$

**Proof.** I. *The condition is necessary.* It is to be proved that if  $b_2$  and  $b_1$  are the upper and lower bounds of indetermination of  $f(x)$ , as  $x \doteq a$  on  $[x]$ , then for every four numbers  $a_1 < b_1 < c_1 < c_2 < b_2 < a_2$  there exists a  $V^*(a)$  such that:—

(1) For all values of  $x$  on  $V^*(a)$ ,  $a_1 < f(x) < a_2$ . If this conclusion does not follow, then for a particular pair of numbers  $a_1, a_2$ , there are values of  $f(x)$  greater than  $a_2$  or less than  $a_1$  for  $x$  on any  $V^*(a)$ , and by Theorems 24 and 40 there is at least one value approached greater than  $b_2$  or less than  $b_1$ . This would contradict the hypothesis, and there is therefore a  $V^*(a)$  such that for all values of  $x$  on  $V^*(a)$ ,  $a_1 < f(x) < a_2$ .

(2) For some  $x', x''$  on  $V^*(a)$ ,  $f(x') > c_2$  and  $f(x'') < c_1$ . If this conclusion should not follow, then for some  $V^*(a)$  there would be no  $x'$  such that  $f(x') > c_2$ , or no  $x''$  such that  $f(x'') < c_1$ , and therefore  $b_1$  and  $b_2$  could not both be values approached.

II. *The condition is sufficient.* It is to be proved that  $b_2$  and  $b_1$  are the upper and lower bounds of the values approached. If the condition is satisfied, then for every four numbers  $a_1, a_2, c_1, c_2$ , such that  $a_1 < b_1 < c_1 < c_2 < b_2 < a_2$  there is a  $V^*(a)$  such that for all  $x$ 's on  $V^*(a)$   $a_1 < f(x) < a_2$ , and for some  $x', x''$ ,  $f(x') > c_2$  and  $f(x'') < c_1$ . By Theorem 24 there are values approached, and hence we need only to show that  $b_2$  is the least upper and  $b_1$  the greatest lower bound of the values approached. Suppose some  $B > b_2$  is the least upper bound of the values approached;  $a_2$  may then be so chosen that  $b_2 < a_2 < B$ , so that by hypothesis for  $x$  on  $V^*(a)$   $B$  cannot be a value approached. Again, suppose  $B < b_2$  to be the least upper bound;  $c$  may then be chosen so that  $B < c_2$ , and hence for some value  $x'$  on each  $V^*(a)$ ,  $f(x') < c_2$ . By the set of values  $f(x')$  there is at least one value approached. This value is greater than  $c_2 > B$ . Therefore  $B$  cannot be the least upper bound. Since the least upper bound may not be either less than  $b_2$  or greater than  $b_2$ , it must be equal to  $b_2$ . A similar argument will prove  $b_1$  to be the greatest lower bound of the values approached.



# Chapter 5

## CONTINUOUS FUNCTIONS.

### § 1 Continuity at a Point.

The notion of continuous functions will in this chapter, as in the definition on page 48, be confined to single-valued functions. It has been shown in Theorem 34 that if  $f_1(x)$  and  $f_2(x)$  are continuous at a point  $x = a$ , then

$$f_1(x) \pm f_2(x), \quad f_1(x) \cdot f_2(x), \quad f_1(x)/f_2(x), \quad (f_2(x) \neq 0)$$

are also continuous at this point. Corollary 1 of Theorem 39 states that a continuous function of a continuous function is continuous.

The definition of continuity at  $x = a$ , namely,

$$\lim_{x \rightarrow a} f(x) = f(a),$$

is by Theorem 26 equivalent to the following proposition:

*For every  $\varepsilon > 0$  there exists a  $\delta_\varepsilon > 0$  such that if  $|x - a| < \delta_\varepsilon$ , then  $|f(x) - f(a)| < \varepsilon$ .*

It should be noted that the restriction  $x \neq a$  which appears in the general form of Theorem 26 is of no significance here, since for  $x = a$ ,  $|f(x) - f(a)| = 0 < \varepsilon$ . In other words, we may deal with vicinities of the type  $V(a)$  instead of  $V^*(a)$ .

The difference of the least upper and the greatest lower bound of a function on an interval  $\overline{ab}$  has been called in Chapter IV, page 66, the oscillation of  $f(x)$  on that interval, and denoted by  $O_a^b(x)$ . The definition of continuity and Theorem 27, Chapter III, give the following necessary and sufficient condition for the continuity of a function  $f(x)$  at  $a$ : *For every  $\varepsilon > 0$  there exists a  $\delta_\varepsilon > 0$  such that if  $|x_1 - a| < \delta_\varepsilon$ , and  $|x_2 - a| < \delta_\varepsilon$  then  $|f(x_1) - f(x_2)| < \frac{\varepsilon}{2}$ . This means that for all values of  $x_1$  and  $x_2$  on the segment  $\overline{(a - \delta_\varepsilon)(a + \delta_\varepsilon)}$*

$$\overline{B}f(x_1) - \underline{B}f(x_2) \leq \frac{\varepsilon}{2} < \varepsilon,$$

and this means

$$\overline{B}f(x) - \underline{B}f(x) < \varepsilon,$$

or

$$O_{a-\delta_\varepsilon}^{a+\delta_\varepsilon} f(x) < \varepsilon.$$

Then we have

**Theorem 45.** *If  $f(x)$  is continuous for  $x = a$ , then for every  $\varepsilon > 0$  there exists a  $V_\varepsilon(a)$  such that on  $V_\varepsilon(a)$  the oscillation of  $f(x)$  is less than  $\varepsilon$ .*

**Theorem 46.** *If  $f(x)$  is continuous at a point  $x = a$  and if  $f(a)$  is positive, then there is a neighborhood of  $x = a$  upon which the function is positive.*

**Proof.** If there were values of  $x$ ,  $[x']$  within every neighborhood of  $x = a$  for which the function is equal to or less than zero, then by Theorem 24 there would be a value approached by  $f(x')$  as  $x'$  approaches  $a$  on the set  $[x']$ . That is, by Theorem 40, there would be a negative or zero value approached by  $f(x)$ , which would contradict the hypothesis.

## § 2 Continuity of a Function on an Interval.

**Definition.**—A function is said to be continuous on an interval  $\overline{a b}$  if it is continuous at every point on the interval.

**Theorem 47.** *If  $f(x)$  is continuous on a finite interval  $\overline{a b}$ , then for every  $\varepsilon > 0$ ,  $\overline{a b}$  can be divided into a finite number of equal intervals upon each of which the oscillation of  $f(x)$  is less than  $\varepsilon$ .<sup>1</sup>*

**Proof.** By Theorem 45 there is about every point of  $\overline{a b}$  a segment  $\sigma$  upon which the oscillation is less than  $\varepsilon$ . This set of segments  $[\sigma]$  covers  $\overline{a b}$ , and by Theorem 11  $\overline{a b}$  can be divided into a finite number of equal intervals each of which is interior to a  $\sigma$ ; this gives the conclusion of our theorem.

**Theorem 48.** (*Uniform continuity.*) *If a function is continuous on a finite interval  $\overline{a b}$ , then for every  $\varepsilon > 0$  there exists a  $\delta_\varepsilon > 0$  such that for any two values of  $x$ ,  $x_1$ , and  $x_2$ , on  $\overline{a b}$  where  $|x_1 - x_2| < \delta_\varepsilon$ ,  $|f(x_1) - f(x_2)| < \varepsilon$ .*

**Proof.** This theorem may be inferred in an obvious way from the preceding theorem, or it may be proved directly as follows:

By Theorem 27, for every  $\varepsilon$  there exists a neighborhood  $V_\varepsilon(x')$  of every  $x'$  of  $\overline{a b}$  such that if  $x_1$  and  $x_2$  are on  $V_\varepsilon(x')$ , then  $|f(x_1) - f(x_2)| < \varepsilon$ . The  $V_\varepsilon(x)$ 's constitute a set of segments which cover  $\overline{a b}$ . Hence, by Theorem 12, there is a  $\delta_\varepsilon$  such that if  $|x_1 - x_2| < \delta_\varepsilon$ ,  $x_1$  and  $x_2$  are on the same  $V_\varepsilon(x')$  and consequently  $|f(x_1) - f(x_2)| < \varepsilon$ .

<sup>1</sup>The importance of this theorem in proving the properties of continuous functions seems first to have been recognized by GOURSAT. See his *Cours d'Analyse*, Vol. 1, page 161.



The uniform continuity theorem is due to E. HEINE.<sup>2</sup> The proof given by him is essentially that given above.

In 1873 LÜROTH<sup>3</sup> gave another proof of the theorem which is based on the following definition of continuity:

A single-valued function is continuous at a point  $x = a'$  if for every positive  $\varepsilon$  there exists a  $\delta_\varepsilon$ , such that for every  $x_1$  and  $x_2$  on the interval  $\overline{a - \delta_\varepsilon, a + \delta_\varepsilon}$ ,  $|f(x_1) - f(x_2)| < \varepsilon$  (Theorem 45).

By Theorem 42 there exists a greatest  $\delta$  for a given point and for a given  $\varepsilon$ . Denote this by  $\Delta_\varepsilon(x)$ . If the function is continuous at every point of  $\overline{a, b}$ , then for every  $\varepsilon$  there will be a value of  $\Delta_\varepsilon(x)$  for every point of the interval, i.e.,  $\Delta_\varepsilon(x)$ , for any particular  $\varepsilon$ , will be a single-valued function of  $x$ .

The essential part of LÜROTH'S proof consists in establishing the following fact: If  $f(x)$  is continuous at every point of its interval, then for any particular value of  $\varepsilon$  the function  $\Delta_\varepsilon(x)$  is also a continuous function of  $x$ . From this it follows by Theorem 50 that the function  $\Delta_\varepsilon(x)$  will actually reach its greatest lower bound, that is, will have a minimum value; and this minimum value, like all other values of  $\delta_\varepsilon$ , will be positive.<sup>4</sup> This minimum value of  $\Delta_\varepsilon(x)$  on the interval under consideration will be effective as a  $\delta_\varepsilon$ , independent of  $x$ .

The property of a continuous function exhibited above is called uniform continuity, and Theorem 48 may be briefly stated in the form: *Every function continuous on an interval is uniformly continuous on that interval.*<sup>5</sup>

This theorem is used, for example, in proving the integrability of continuous functions. See page 125.

**Theorem 49.** *If a function is continuous on an interval  $\overline{a, b}$ , it is bounded on that interval.*

**Proof.** By Theorem 46 the interval  $\overline{a, b}$  can be divided into a finite number of intervals, such that the oscillation on each interval is less than a given positive number  $\varepsilon$ . If the number of intervals is  $n$ , then the oscillation on the interval  $\overline{a, b}$  is less than  $n\varepsilon$ . Since the function is defined at all points of the interval, its value being  $f(x_1)$  at some point  $x_1$ , it follows that every value of  $f(x)$  on  $\overline{a, b}$  is less than  $f(x_1) + n\varepsilon$  and greater than  $f(x_1) - n\varepsilon$ ; which proves the theorem.

<sup>2</sup>E. HEINE: *Die Elemente der Functionenlehre*, Crelle, Vol. 74 (1872), p. 188.

<sup>3</sup>LÜROTH: *Bemerkung über Gleichmässige Stetigkeit*, *Mathematische Annalen*, Vol. 6, p. 319.

<sup>4</sup>It is interesting to note that this proof will not hold if the condition of Theorem 26 is used as a definition of continuity. On this point see N. J. LENNES: *The Annals of Mathematics*, second series, Vol. 6, p. 86.

<sup>5</sup>It should be noticed that this theorem does not hold if "segment" is substituted for "interval," as is shown by the function  $\frac{1}{x}$  on the segment  $\overline{0, 1}$ , which is continuous but not uniformly continuous. The function is defined and continuous for every value of  $x$  on this *segment*, but not for every value of  $x$  on the *interval*  $\overline{0, 1}$ .

**Theorem 50.** If a function  $f(x)$  is continuous on an interval  $a b$ , then the function assumes as values its least upper and its greatest lower bound.

**Proof.** By the preceding theorem the function is bounded and hence the least upper and greatest lower bounds are finite. By Theorem 19 there is a point  $k$  on the interval  $a b$  such that the least upper bound of the function on every neighborhood of  $x = k$  is the same as the least upper bound on the interval  $a b$ . Denote the least upper bound of  $f(x)$  on  $a b$  by  $B$ . It follows from Theorem 43 that  $B$  is a value approached by  $f(x)$  as  $x$  approaches  $k$ . But since  $\lim_{x \rightarrow k} f(x) = f(k)$ , the function being continuous at  $x = k$ , we have that  $f(k) = B$ . In the same manner we can prove that the function reaches its greatest lower bound.

*Corollary.*—If  $k$  is a value not assumed by a continuous function on an interval  $a b$ , then  $f(x) - k$  or  $k - f(x)$  is a continuous function of  $x$  and assumes its least upper and greatest lower bounds. That is, there is a definite number  $\Delta$  which is the least difference between  $k$  and the set of values of  $f(x)$  on the interval  $a b$ .

**Theorem 51.** If a function is continuous on an interval  $a b$ , then the function takes on all values between its least upper and its greatest lower bound.

**Proof.** If there is a value  $k$  between these bounds which is not assumed by a continuous function  $f(x)$ , then by the corollary of the preceding theorem there is a value  $\Delta$  such that no values of  $f(x)$  are between  $k - \Delta$  and  $k + \Delta$ . With  $\varepsilon$  less than  $\Delta$  divide the interval  $a b$  into subintervals according to Theorem 47, such that the oscillation on every interval is less than  $\varepsilon$ . No interval of this set can contain values of  $f(x)$  both greater and less than  $k$ , and no two consecutive intervals can contain such values. Suppose the values of  $f(x)$  on the first interval of this set are all greater than  $k$ , then the same is true of the second interval of the set, and so on. Hence it follows that all values of  $f(x)$  on  $a b$  are either greater than or less than  $k$ , which is contrary to the hypothesis that  $k$  lies between the least upper and the greatest lower bounds of the function on  $a b$ . Hence the hypothesis that  $f(x)$  does not assume the value  $k$  is untenable.

By the aid of Theorem 51 we are enabled to prove the following:

**Theorem 51a.** If  $f_1(x)$  is continuous at every point of an interval  $a' b'$  except at a certain point  $a$ , and if

$$\lim_{x \rightarrow a} f_1(x) = +\infty \text{ and } \lim_{x \rightarrow a} f_2(x) = -\infty,$$

then for every  $b$ , finite or  $+\infty$  or  $-\infty$ , there exist two sequences of points,  $[x_i]$  and  $[x'_i]$  ( $i = 0, 1, 2, \dots$ ), each sequence having  $a$  as a limit point, such that

$$\lim_{i \rightarrow \infty} \{f_1(x_i) + f_2(x'_i)\} = b.$$

**Proof.** Let  $[x'_i]$  be any sequence whatever on  $\overline{a' b'}$  having  $a$  as a limit point, and let  $x_0$  be an arbitrary point of  $\overline{a' b'}$ . Since  $f_1(x)$  assumes all values between  $f_1(x_0)$  and  $+\infty$ , and since  $\lim_{x \rightarrow a} f_2(x) = -\infty$ , it follows, in case  $b$  is finite, that for every  $i$  greater than some fixed value there exists an  $x_i$  such that

$$f_1(x_i) + f_2(x'_i) = b.$$

In case  $b = +\infty$ ,  $x_i$  is chosen so that

$$f_1(x_i) + f_2(x'_i) > i.$$

*Corollary.*—Whether  $f_1(x)$  and  $f_2(x)$  are continuous or not, if  $\lim_{x \rightarrow a} f_1(x) = +\infty$  and  $\lim_{x \rightarrow a} f_2(x) = -\infty$ , there exists a pair of sequences  $[x_i]$  and  $[x'_i]$  such that

$$\lim_{i \rightarrow \infty} \{f_1(x_i) + f_2(x'_i)\}$$

is  $+\infty$  or  $-\infty$ .

**Theorem 52.** *If  $y$  is a function,  $f(x)$ , of  $x$ , monotonic and continuous on an interval  $\overline{a b}$ , then  $x = f^{-1}(y)$  is a function of  $y$  which is monotonic and continuous on the interval  $\overline{f(a) f(b)}$ .*

**Proof.** By Theorem 20 the function  $f^{-1}(y)$  is monotonic and has as upper and lower bounds  $a$  and  $b$ . By Theorems 50 and 51 the function is defined for every value of  $y$  between and including  $f(a)$  and  $f(b)$  and for no other values. We prove the function continuous on the interval  $\overline{f(a) f(b)}$  by showing that it is continuous at any point  $y = y_1$  on this interval. As  $y$  approaches  $y_1$  on the interval  $\overline{f(a) y_1}$ ,  $f^{-1}(y)$  approaches a definite limit  $g$  by Theorem 25, and by Theorem 40  $a < g \leq f^{-1}(y_1) \leq b$ . If  $g < f^{-1}(y_1)$ , then for values of  $x$  on the interval  $\overline{g f(y_1)}$  there is no corresponding value of  $y$ , contrary to the hypothesis that  $f(x)$  is defined at every point of the interval  $\overline{a b}$ . Hence  $g = f^{-1}(y_1)$ , and by similar reasoning we show that  $f^{-1}(y)$  approaches  $f^{-1}(y_1)$  as  $y$  approaches  $y_1$  on the interval,  $\overline{y_1 f^{-1}(b)}$ .

**Theorem 53.** *If  $f(x)$  is single-valued and continuous with  $A, B$  as lower and upper bounds, on an interval  $\overline{a b}$  and has a single-valued inverse on the interval,  $\overline{A B}$  then  $f(x)$  is monotonic on  $\overline{a b}$ .*

**Proof.** If  $f(x)$  is not monotonic, then there must be three values of  $x$ ,

$$x_1 < x_2 < x_3,$$

such that either

$$f(x_1) \leq f(x_2) \geq f(x_3)$$

or

$$f(x_1) \geq f(x_2) \leq f(x_3).$$

In either case, if one of the equality signs holds, the hypothesis that  $f(x)$  has a single-valued inverse is contradicted. If there are no equality signs, it follows by Theorem 51 that there are two values of  $x$ ,  $x_4$  and  $x_5$ , such that

$$x_1 < x_4 < x_2 < x_5 < x_3,$$

and  $f(x_4) = f(x_5)$ , in contradiction with the hypothesis that  $f(x)$  has a single-valued inverse.

*Corollary.*—If  $f(x)$  is single-valued, continuous, and has a single-valued inverse on an interval  $\overline{a b}$ , then the inverse function is monotonic on  $\overline{A B}$ .

### § 3 Functions Continuous on an Everywhere Dense Set.

**Theorem 54.** If the functions  $f_1(x)$  and  $f_2(x)$  are continuous on the interval  $\overline{a b}$ , and if  $f_1(x) = f_2(x)$  on a set everywhere dense, then  $f_1(x) = f_2(x)$  on the whole interval.<sup>6</sup>

**Proof.** Let  $[x']$  be the set everywhere dense on  $\overline{a b}$  for which, by hypothesis,  $f_1(x) = f_2(x)$ . Let  $x''$  be any point of the interval not of the set  $[x']$ . By hypothesis  $x''$  is a limit point of the set  $[x']$ , and further  $f_1(x)$  and  $f_2(x)$  are continuous at  $x = x''$ . Hence

$$\lim_{x \rightarrow x''} f_1(x) = f_1(x'')$$

and

$$\lim_{x \rightarrow x''} f_2(x) = f_2(x'').$$

But by Theorem 41

$$\lim_{x' \rightarrow x''} f_1(x') = \lim_{x \rightarrow x''} f_1(x),$$

---

<sup>6</sup>I.e., if a function  $f(x)$ , continuous on an interval  $\overline{a b}$ , is known on an everywhere dense set on that interval, it is known for every point on that interval.

and by Theorem 41

$$\lim_{x' \doteq x''} f_2(x') = \lim_{x \doteq x''} f_2(x).$$

Therefore

$$f_1(x'') = f_2(x'').$$

**Definition.**—On an interval  $\overline{a b}$  a function  $f(x')$  is *uniformly continuous* over a set  $[x']$  if for every  $\varepsilon > 0$  there exists a  $\delta_\varepsilon > 0$  such that for any two values of  $x'$ ,  $x'_1$ , and  $x'_2$  an  $\overline{a b}$ , for which  $|x'_1 - x'_2| < \delta_\varepsilon$ ,  $|f(x'_1) - f(x'_2)| < \varepsilon$ .

**Theorem 55.** *If a function  $f(x')$  is defined on a set everywhere dense on the interval  $\overline{a b}$  and is uniformly continuous over that set, then there exists one and only one function  $f(x)$  defined on the full interval  $\overline{a b}$  such that:*

(1)  $f(x)$  is identical with  $f(x')$  where  $f(x')$  is defined.

(2)  $f(x)$  is continuous on the interval  $\overline{a b}$ .

**Proof.** Let  $x''$  be any point on the interval  $\overline{a b}$ , but not of the set  $[x']$ . We first prove that

$$\lim_{x' \doteq x''} f(x')$$

exists and is finite. By the definition of uniform continuity, for every  $\varepsilon$  there exists a  $\delta_\varepsilon$  such that for any two values of  $x'$ ,  $x'_1$ , and  $x'_2$ , where  $|x'_1 - x'_2| < \delta_\varepsilon$ ,  $|f(x'_1) - f(x'_2)| < \varepsilon$ . Hence we have for every pair of values  $x'_1$  and  $x'_2$  where  $|x'_1 - x''| < \frac{\delta_\varepsilon}{2}$  and  $|x'_2 - x''| < \frac{\delta_\varepsilon}{2}$  that  $|f(x'_1) - f(x'_2)| < \varepsilon$ . By Theorem 23 this is a sufficient condition that

$$\lim_{x' \doteq x''} f(x')$$

shall exist and be finite.

Let  $f(x)$  denote a function identical with  $f(x')$  on the set  $[x']$  and equal to

$$\lim_{x' \doteq x''} f(x')$$

at all points  $x''$ . This function is defined upon the continuum, since all points  $x''$  on  $\overline{a b}$  are limit points of the set  $[x']$ . Hence the function has the property that  $\lim_{x_1 \doteq x} f(x') = f(x)$

for every  $x$  of  $\overline{a b}$ .

We next prove that  $f(x)$  is continuous at every point on the interval  $a \overline{b}$ , in other words that  $f(x)$  cannot approach a value  $b$  different from  $f(x_1)$  as  $x$  approaches  $x_1$ . We already know that  $f(x)$  approaches  $f(x_1)$  on the set  $[x']$ . If  $b$  is another value approached, then for every positive  $\varepsilon$  and  $\delta$  there is an  $x_{\varepsilon\delta}$  such that

$$|x_{\varepsilon\delta} - x_1| < \delta, \quad |f(x_{\varepsilon\delta}) - b| < \varepsilon. \quad (1)$$

Since  $f(x_{\varepsilon\delta}) = \lim_{x' \rightarrow x_{\varepsilon\delta}} f(x')$  we have that for every  $\varepsilon > 0$  there exists a  $\delta_\varepsilon > 0$  such that for every  $x'$  for which  $|x' - x_{\varepsilon\delta}| < \delta_\varepsilon$ ,

$$|f(x') - f(x_{\varepsilon\delta})| < \varepsilon. \quad (2)$$

From (1) and (2) we have

$$|f(x') - b| < 2\varepsilon. \quad (3)$$

Since the  $\delta$  of (1) is any positive number, there is an  $x_{\varepsilon\delta}$  on every neighborhood of  $x_1$  and hence by (2) and (3) an  $x'$  on every neighborhood of  $x_1$  such that  $|f(x') - b| < 2\varepsilon$ ,  $\varepsilon$  being arbitrary and  $b$  a constant different from  $f(x_1)$ . But this is contrary to the fact proved above, that  $\lim_{x' \rightarrow x_1} f(x')$  exists and is equal to  $f(x_1)$ . Hence the function is continuous

at every point of the interval  $a \overline{b}$ . The uniqueness of the function follows directly from Theorem 54.

This theorem can be applied, for example, to give an elegant definition of the exponential function (see Chap. III). We first show that the function  $a^{\frac{m}{n}}$  is uniformly continuous on the set of all rational values between  $x_1$  and  $x_2$ , and then define  $a^x$  on the continuum as that continuous function which coincides with  $a^{\frac{m}{n}}$  for the rational values  $\frac{m}{n}$ . The properties of the function then follow very easily. It will be an excellent exercise for the reader to carry out this development in detail.

## § 4 The Exponential Function.

Consider the function defined by the infinite series

$$1 + x + \frac{x^2}{2!} + \frac{x^3}{3!} + \dots + \frac{x^n}{n!} + \dots \quad (1)$$

Applying the ratio test for the convergence of infinite series we have

$$\frac{x^n}{n!} \div \frac{x^{n-1}}{(n-1)!} = \frac{x}{n}.$$

If  $n'$  is a fixed integer larger than  $x$ , this ratio is always less than  $\frac{x}{n'} < 1$ . The series (1) therefore converges absolutely for every value of  $x$ , and we may denote its sum by

$$e(x).$$

From Chap. I, page 12, we have that

$$e(1) = \underset{n \doteq \infty}{L} \left(1 + \frac{1}{n}\right)^n = e.$$

**Theorem 56.**

$$\underset{n \doteq \infty}{L} \left(1 + \frac{x}{n}\right)^n,$$

where  $[n]$  is the set of all positive integers, exists and is equal to  $e(x)$  for all values of  $x$ .

**Proof.** Let

$$E_n(x) = \sum_{k=0}^n \frac{x^k}{k!}$$

(where  $0! = 1$ ). Then, since

$$\left(1 + \frac{x}{n}\right)^n = 1 + \frac{n!}{(n-1)!} \cdot \frac{x}{n} + \frac{n!}{(n-2)! \cdot 2!} \left(\frac{x}{n}\right)^2 + \dots + \frac{n!}{n!} \left(\frac{x}{n}\right)^n,$$

it follows that

$$\begin{aligned} \left|E_n(x) - \left(1 + \frac{x}{n}\right)^n\right| &= \left|\sum_{k=2}^n \left(\frac{1}{k!} - \frac{n!}{(n-k)! \cdot k! n^k}\right) x^k\right| \\ &\leq \sum_{k=2}^n \left(\frac{1}{k!} - \frac{n(n-1)\dots(n-k+1)}{k! n^k}\right) \cdot |x^k| \\ &< \sum_{k=2}^n \frac{n^k - (n-k+1)^k}{k! n^k} \cdot |x^k|. \end{aligned}$$

Now, since

$$\begin{aligned} n^k - (n-k+1)^k &= (k-1)\{n^{k-1} + n^{k-2} \cdot (n-k+1) + \dots \\ &\quad + (n-k+1)^{k-1}\} < (k-1)k \cdot n^{k-1}, \end{aligned}$$

it follows that

$$\left|E_n(x) - \left(1 + \frac{x}{n}\right)^n\right| < \sum_{k=2}^n \frac{|x|^k}{(k-2)! \cdot n} < \frac{x^2 \cdot e(|x|)}{n}.$$

For a fixed value of  $x$ , therefore, we have

$$\left(1 + \frac{x}{n}\right)^n = E_n(x) + \varepsilon_1(n),$$

where  $\varepsilon_1(n)$  is an infinitesimal as  $n \doteq \infty$ .

At the same time

$$e(x) = E_n(x) + \varepsilon_2(n),$$

where  $\varepsilon_2(n)$  is an infinitesimal as  $n \doteq \infty$ . Hence

$$\underset{n \doteq \infty}{L} \left(1 + \frac{x}{n}\right)^n = e(x).$$

**Theorem 57.**

$$L_{z \doteq \infty} \left( 1 + \frac{x}{z} \right),$$

where  $[z]$  is the set of all real numbers, exists and is equal to  $e(x)$ .

**Proof.** If  $z$  is any number greater than 1, let  $n_z$  be the integer such that

$$n_z \leq z < n_z + 1.$$

Hence, if  $x > 0$ ,

$$1 + \frac{x}{n_z} \geq 1 + \frac{x}{z} > 1 + \frac{x}{n_z + 1}. \quad (1)$$

Hence

$$\left( 1 + \frac{x}{n_z} \right)^{n_z + 1} \geq \left( 1 + \frac{x}{z} \right)^z > \left( 1 + \frac{x}{n_z + 1} \right)^{n_z}, \quad (2)$$

or

$$\left( 1 + \frac{x}{n_z} \right) \left( 1 + \frac{x}{n_z} \right)^{n_z} \geq \left( 1 + \frac{x}{z} \right)^z > \left( 1 + \frac{x}{n_z + 1} \right)^{n_z + 1} \cdot \frac{1}{1 + \frac{x}{n_z + 1}}. \quad (3)$$

Since

$$L_{z \doteq \infty} \left( 1 + \frac{x}{n_z} \right) = 1, \quad \text{and} \quad L_{z \doteq \infty} \left( 1 + \frac{x}{n_z + 1} \right) = 1,$$

and

$$L_{z \doteq \infty} \left( 1 + \frac{x}{n_z} \right)^{n_z} = e(x), \text{ and } L_{z \doteq \infty} \left( 1 + \frac{x}{n_z + 1} \right)^{n_z + 1} = e(x),$$

the inequality (3), together with Corollary 3, Theorem 40, leads to the result:

$$L_{z \doteq \infty} \left( 1 + \frac{x}{z} \right)^z = e(x).$$

The argument is similar if  $x < 0$ .

*Corollary.*—

$$L_{z \doteq \infty} \left( 1 + \frac{x}{z} \right)^z = e(x),$$

where  $[z]$  is any set of numbers with limit point  $+\infty$ .

**Theorem 58.** *The function  $e(x)$  is the same as  $e^x$  where*

$$e = 1 + 1 + \frac{1}{2!} + \frac{1}{3!} + \dots$$



**Proof.** By the continuity of  $z^x$  as a function of  $z$  (see Corollary 2 of Theorem 39), it follows that, since

$$\begin{aligned} L_{n \doteq \infty} \left(1 + \frac{1}{n}\right)^n &= e, \\ L_{n \doteq \infty} \left(1 + \frac{1}{n}\right)^{nx} &= e^x. \end{aligned}$$

But

$$\left(1 + \frac{1}{n}\right)^{nx} = \left(1 + \frac{x}{nx}\right)^{nx} = \left(1 + \frac{x}{z}\right)^z,$$

where  $z = nx$ . Hence by Theorem 39

$$e^x = L_{z \doteq \infty} \left(1 + \frac{x}{z}\right)^z,$$

and by the corollary of Theorem 57 the latter expression is equal to  $e(x)$ . Hence we have

$$e^x = 1 + x + \frac{x^2}{2!} + \frac{x^3}{3!} + \dots \quad (1)$$

(1) is frequently used as the definition of  $e^x$ ,  $a^x$  being defined as  $e^x \cdot \log_e a$ .



# Chapter 6

## INFINITESIMALS AND INFINITES.

### § 1 The Order of a Function at a Point.

An infinitesimal has been defined (page 59) as a function  $f(x)$  such that

$$\lim_{x \rightarrow a} f(x) = 0.$$

A function which is unbounded in every vicinity of  $x = a$  is said to have an *infinity* at  $a$ , to be or become infinite at  $x = a$ , or to have an *infinite singularity* at  $x = a$ .<sup>1</sup> The reciprocal of an infinitesimal at  $x = a$  is infinite at this point.

A function may be infinite at a point in a variety of ways:

- (a) It may be monotonic and approach  $+\infty$  or  $-\infty$  as  $x \rightarrow a$ ; for example,  $\frac{1}{x}$  as  $x$  approaches zero from the positive side.
- (b) It may oscillate on every neighborhood of  $x = a$  and still approach  $+\infty$  or  $-\infty$  as a unique limit; for example,

$$\frac{\sin \frac{1}{x} + 2}{x}$$

as  $x$  approaches zero.

- (c) It may approach any set of real numbers or the set of all real numbers; an example of the latter is

$$\frac{\sin \frac{1}{x}}{x}$$

as  $x$  approaches zero. See Fig. 13, page 50.

---

<sup>1</sup>It is perfectly compatible with these statements to say that while  $f(x)$  has an infinite singularity at  $x = a$ ,  $f(a) = 0$  or any other finite number. For example, a function which is  $\frac{1}{x}$  for all values of  $x$  except  $x = 0$  is left undefined for  $x = 0$  and hence at this point the function may be defined as zero or any other number. This function illustrates very well how a function which has a finite value at every point may nevertheless have infinite singularities.

(d)  $+\infty$  and  $-\infty$  may both be approached while no other number is approached; for example,  $\frac{1}{x}$  as  $x$  approaches zero from both sides.

**Definition of Order.**—If  $f(x)$  and  $\phi(x)$  are two functions such that in some neighborhood  $V^*(a)$  neither of them changes sign or is zero, and if

$$L_{x \dot{=} a} \frac{f(x)}{\phi(x)} = k,$$

where  $k$  is finite and not zero, then  $f(x)$  and  $\phi(x)$  are said to be of the *same order* at  $x = a$ . If

$$L_{x \dot{=} a} \frac{f(x)}{\phi(x)} = 0,$$

then  $f(x)$  is said to be *infinitesimal with respect to*  $\phi(x)$ , and  $\phi(x)$  is said to be *infinite with respect to*  $f(x)$ . If

$$L_{x \dot{=} a} \frac{f(x)}{\phi(x)} = +\infty \text{ or } -\infty,$$

then, by Theorem 37,  $\phi(x)$  is infinitesimal with respect to  $f(x)$ , and  $f(x)$  infinite with respect to  $\phi(x)$ . If  $f(x)$  and  $\phi(x)$  are both infinitesimal at  $x = a$ , and  $f(x)$  is infinitesimal with respect to  $\phi(x)$ , then  $f(x)$  is infinitesimal of a *higher order* than  $\phi(x)$ , and  $\phi(x)$  of *lower order* than  $f(x)$ . If  $\phi(x)$  and  $f(x)$  are both infinite at  $x = a$ , and  $f(x)$  is infinite with respect to  $\phi(x)$ , then  $f(x)$  is infinite of higher order than  $\phi(x)$ , and  $\phi(x)$  is infinite of lower order than  $f(x)$ .<sup>2</sup>

The independent variable  $x$  is usually said to be an infinitesimal of the first order as  $x$  approaches zero,  $x^2$  of the second order, etc. Any constant  $\neq 0$  is said to be infinite of zero order,  $\frac{1}{x}$  is of the first order,  $\frac{1}{x^2}$  of the second order, etc. This usage, however, is best confined to analytic functions. In the general case there are no two infinitesimals of consecutive order. Evidently there are as many different orders of infinitesimals between  $x$  and  $x^2$  as there are numbers between 1 and 2; i.e.,  $x^{1+k}$  is of higher order than  $x$  for every positive value of  $k$ .

Since  $L_{x \dot{=} a} \frac{f_1(x)}{f_2(x)} = \frac{1}{k}$  whenever  $L_{x \dot{=} a} \frac{f_2(x)}{f_1(x)} = k$ , we have

**Theorem 59.** *If  $f_1(x)$  is of the same order as  $f_2(x)$ , then  $f_2(x)$  is of the same order as  $f_1(x)$ .*

---

<sup>2</sup>This definition of order is by no means as general as it might possibly be made. The restriction to functions which are not zero and do not change sign may be partly removed. The existence of

$$L_{x \dot{=} a} \frac{f(x)}{\phi(x)}$$

is dispensed with for some cases in § 4 on Rank of Infinitesimals and Infinites. For an account of still further generalizations (due mainly to CAUCHY) see E. BOREL, *Séries à Termes Positifs*, Chapters III and IV, Paris, 1902. An excellent treatment of the material of this section together with extensions of the concept of order of infinity is due to E. BORLOTTI, *Calcolo degli Infinitesimi*, Modena, 1905 (62 pages).

**Theorem 60.** *The function  $cf(x)$  is of the same order as  $f(x)$ ,  $c$  being any constant not zero.*

**Proof.** By Theorem 34,  $L_{x \dot{=} a} \frac{cf(x)}{f(x)} = c$ .

**Theorem 61.** *If  $f_1(x)$  is of the same order as  $f_2(x)$ , and  $f_2(x)$  is of the same order as  $f_3(x)$ , then  $f_1(x)$  and  $f_3(x)$  are of the same order.*

**Proof.** By hypothesis  $L_{x \dot{=} a} \frac{f_1(x)}{f_2(x)} = k_1$  and  $L_{x \dot{=} a} \frac{f_2(x)}{f_3(x)} = k_2$ . By Theorem 34,

$$L_{x \dot{=} a} \frac{f_1(x)}{f_2(x)} \cdot L_{x \dot{=} a} \frac{f_2(x)}{f_3(x)} = L_{x \dot{=} a} \frac{f_1(x)}{f_3(x)}.$$

(By definition,  $f_2(x) \neq 0$  and  $f_3(x) \neq 0$  for some neighborhood of  $x = a$ .) Hence

$$L_{x \dot{=} a} \frac{f_1(x)}{f_3(x)} = k_1 \cdot k_2.$$

**Theorem 62.** *If  $f_1(x)$  and  $f_2(x)$  are infinitesimal (infinite) and neither is zero or changes sign on some  $V^*(a)$ , then  $f_1(x) \cdot f_2(x)$  is infinitesimal (infinite) of a higher order than either.*

**Proof.**

$$L_{x \dot{=} a} \frac{f_1(x) \cdot f_2(x)}{f_2(x)} = L_{x \dot{=} a} f_1(x) = 0. (\pm\infty.)$$

**Theorem 63.** *If  $f_1(x), \dots, f_n(x)$  have the same sign on some  $V^*(a)$  and if  $f_2(x), \dots, f_n(x)$  are infinitesimal (infinite) of the same or higher (lower) order than  $f_1(x)$ , then*

$$f_1(x) + f_2(x) + f_3(x) + \dots + f_n(x)$$

*is of the same order as  $f_1(x)$ , and if  $f_2(x), f_3(x), \dots, f_n(x)$  are of higher (lower) order than  $f_1(x)$ , then  $f_1(x) \pm f_2(x) \pm f_3(x) \pm \dots \pm f_n(x)$  is of the same order as  $f_1(x)$ .*

**Proof.** We are to show that

$$L_{x \dot{=} a} \frac{f_1(x) + f_2(x) + \dots + f_n(x)}{f_1(x)} = k \neq 0.$$

By hypothesis,

$$L_{x \dot{=} a} \frac{f_2(x)}{f_1(x)} = k_2, \quad L_{x \dot{=} a} \frac{f_3(x)}{f_1(x)} = k_3, \quad \dots, \quad L_{x \dot{=} a} \frac{f_n(x)}{f_1(x)} = k_n,$$

and

$$L_{x \dot{=} a} \frac{f_1(x)}{f_1(x)} = 1.$$

Hence, by Theorem 30,

$$L_{x \doteq a} \left\{ \frac{f_1(x)}{f_1(x)} + \frac{f_2(x)}{f_1(x)} + \frac{f_3(x)}{f_1(x)} + \dots + \frac{f_n(x)}{f_1(x)} \right\} = 1 + k_2 + \dots + k_n = k \neq 0,$$

since all the  $k$ 's are positive or zero.

Similarly, under the second hypothesis,

$$\begin{aligned} L_{x \doteq a} \frac{f_1(x) \pm f_2(x) \pm \dots \pm f_n(x)}{f_1(x)} &= L_{x \doteq a} \left\{ \frac{f_1(x)}{f_1(x)} \pm \frac{f_2(x)}{f_1(x)} \pm \dots \pm \frac{f_n(x)}{f_1(x)} \right\} \\ &= 1 + 0 + \dots + 0 = 1. \end{aligned}$$

**Theorem 64.** *If  $f_3(x)$  and  $f_4(x)$  are infinitesimals with respect to  $f_1(x)$  and  $f_2(x)$ , then*

$$L_{x \doteq a} \frac{\{f_1(x) + f_3(x)\} \cdot \{f_2(x) + f_4(x)\}}{f_1(x) \cdot f_2(x)} = 1.$$

**Proof.**

$$\begin{aligned} &L_{x \doteq a} \frac{\{f_1(x) + f_3(x)\} \cdot \{f_2(x) + f_4(x)\}}{f_1(x) \cdot f_2(x)} \\ &= L_{x \doteq a} \frac{f_1(x) \cdot f_2(x) + f_1(x) \cdot f_4(x) + f_3(x) \cdot f_2(x) + f_3(x) \cdot f_4(x)}{f_1(x) \cdot f_2(x)} \\ &= L_{x \doteq a} \frac{f_1(x) \cdot f_2(x)}{f_1(x) \cdot f_2(x)} + L_{x \doteq a} \frac{f_1(x) \cdot f_4(x)}{f_1(x) \cdot f_2(x)} + L_{x \doteq a} \frac{f_3(x) \cdot f_2(x)}{f_1(x) \cdot f_2(x)} + L_{x \doteq a} \frac{f_3(x) \cdot f_4(x)}{f_1(x) \cdot f_2(x)} = 1. \end{aligned}$$

## § 2 The Limit of a Quotient.

**Theorem 65.** *If as  $x \doteq a$ ,  $\varepsilon_1(x)$  is an infinitesimal with respect to  $f_1(x)$  and  $\varepsilon_2(x)$  with respect to  $f_2(x)$ , then the values approached by*

$$\frac{f_1(x) + \varepsilon_1(x)}{f_2(x) + \varepsilon_2(x)} \quad \text{and} \quad \frac{f_1(x)}{f_2(x)}$$

*as  $x$  approaches  $a$  are identical.*

**Proof.** This follows from the identity

$$\frac{f_1(x) + \varepsilon_1(x)}{f_2(x) + \varepsilon_2(x)} = \frac{f_1(x)}{f_2(x)} \cdot \frac{\left(1 + \frac{\varepsilon_1(x)}{f_1(x)}\right)}{\left(1 + \frac{\varepsilon_2(x)}{f_2(x)}\right)},$$

since  $\frac{\varepsilon_1(x)}{f_1(x)}$  and  $\frac{\varepsilon_2(x)}{f_2(x)}$  are infinitesimal.

*Corollary.*—If  $f_1(x)$  and  $f_2(x)$  are infinite at  $x = a$ , then

$$\frac{f_1(x) + c}{f_2(x) + d} \quad \text{and} \quad \frac{f_1(x)}{f_2(x)}$$

approach the same values.

**Theorem 66.** *If  $L_{x \doteq a} \frac{f_1(x)}{\phi_1(x)} = L_{x \doteq a} \frac{f_2(x)}{\phi_2(x)} = k$ , and if  $L_{x \doteq a} \frac{\phi_1(x)}{\phi_2(x)} = l$  is finite, then*

$$k = L_{x \doteq a} \frac{f_1(x) + f_2(x)}{\phi_1(x) + \phi_2(x)} = L_{x \doteq a_1} \frac{f_1(x)}{\phi_1(x)},$$

*provided  $l \neq -1$  if  $k$  is finite, and provided  $l > 0$  if  $k$  is infinite.*

**Proof.**

$$\begin{aligned} \frac{f_1(x) + f_2(x)}{\phi_1(x) + \phi_2(x)} - \frac{f_2(x)}{\phi_2(x)} &= \frac{f_1(x)\phi_2(x) - f_2(x)\phi_1(x)}{\phi_2(x)(\phi_1(x) + \phi_2(x))}, \\ \frac{f_1(x) + f_2(x)}{\phi_1(x) + \phi_2(x)} &= \frac{f_2(x)}{\phi_2(x)} + \left( \frac{f_1(x)}{\phi_1(x)} - \frac{f_2(x)}{\phi_2(x)} \right) \cdot \left( \frac{1}{1 + \frac{\phi_2(x)}{\phi_1(x)}} \right). \end{aligned}$$

In case  $k$  is finite, the second term of the right-hand member is evidently infinitesimal if  $l \neq -1$  and the theorem is proved. In the case where  $k$  is infinite we write the above identity in the following form:

$$\frac{f_1(x) + f_2(x)}{\phi_1(x) + \phi_2(x)} = \frac{f_1(x)}{\phi_1(x)} \cdot \frac{1}{1 + \frac{\phi_2(x)}{\phi_1(x)}} + \frac{f_2(x)}{\phi_2(x)} \cdot \frac{1}{1 + \frac{\phi_1(x)}{\phi_2(x)}}.$$

Both terms of the second member approach  $+\infty$  or both  $-\infty$  if  $l > 0$ .

*Corollary.*—If  $\phi_1(x)$  and  $\phi_2(x)$  are both positive for some  $V^*(a)$ , and if  $k = L_{x \doteq a} \frac{f_1(x)}{\phi_1(x)} = L_{x \doteq a} \frac{f_2(x)}{\phi_2(x)}$ , then  $L_{x \doteq a} \frac{f_1(x) + f_2(x)}{\phi_1(x) + \phi_2(x)} = k$  whenever  $k$  is finite. If  $k$  is infinite, the condition must be added that  $\frac{\phi_1(x)}{\phi_2(x)}$  has a finite upper and a non-zero lower bound.

**Theorem 67.** *If  $f_1(x)$  and  $f_2(x)$  are both infinitesimals as  $x \doteq a$ , then a necessary and sufficient condition that*

$$L_{x \doteq a} \frac{f_1(x)}{f_2(x)} = k \quad (k \text{ finite and not zero})$$

*is that in the equation  $f_1(x) = k \cdot f_2(x) + \varepsilon(x)$ ,  $\varepsilon(x)$  is an infinitesimal of higher order than  $f_1(x)$  or  $f_2(x)$ .*

**Proof.** (1) *The condition is necessary.*—Since  $\lim_{x \rightarrow a} \frac{f_1(x)}{f_2(x)} = k$ ,

$$\frac{f_1(x)}{f_2(x)} = k + \varepsilon'(x),$$

or  $f_1(x) = f_2(x) \cdot k + f_2(x) \cdot \varepsilon'(x)$ , where  $\lim_{x \rightarrow a} \varepsilon'(x) = 0$  (Theorem 31). By Theorems 60 and 61,  $f_1(x)$  and  $f_2(x) \cdot k$  are of the same order, since  $k \neq 0$ , while by Theorem 62  $\varepsilon'(x) \cdot f_2(x)$  is of higher order than either  $f_1(x)$  or  $f_2(x)$ . Hence the function  $\varepsilon(x) = \varepsilon'(x) \cdot f_2(x)$  is infinitesimal.

(2) *The condition is sufficient.*—By hypothesis  $f_1(x) = f_2(x) \cdot k + \varepsilon(x)$ , where  $f_1(x)$  and  $f_2(x)$  are of the same order as  $x \rightarrow a$ , while  $\varepsilon(x)$  is of higher order than these. Let  $\varepsilon'(x) = \frac{\varepsilon(x)}{f_2(x)}$ , which by hypothesis is an infinitesimal. We then have  $\frac{f_1(x)}{f_2(x)} = k + \varepsilon'(x)$ .

Hence, by Theorem 31,  $\lim_{x \rightarrow a} \frac{f_1(x)}{f_2(x)} = k$ .

### § 3 Indeterminate Forms.<sup>3</sup>

**Lemma.**—If  $\frac{a}{b}$  and  $\frac{c}{d}$  are any two fractions such, that  $b$  and  $d$  are both positive or both negative, then the value of

$$\frac{a+c}{b+d}$$

lies on the interval  $\frac{a}{b}$  —  $\frac{c}{d}$ .

**Proof.** Suppose  $b$  and  $d$  both positive and

$$\frac{a}{b} \geq \frac{a+c}{b+d},$$

then

$$\begin{aligned} ab + ad &\geq ab + bc. \\ \therefore ad &\geq bc; \\ \therefore cd + ad &\geq cd + bc; \\ \therefore \frac{a+c}{b+d} &\geq \frac{c}{d}. \end{aligned}$$

The other cases follow similarly.

**Theorem 68.** If  $f(x)$  and  $\phi(x)$ , defined on some  $V(+\infty)$ , are both infinitesimal as  $x$  approaches  $+\infty$ , and if for some positive number  $h$ ,  $\phi(x+h)$  is always less than  $\phi(x)$  and

$$\lim_{x \rightarrow \infty} \frac{f(x+h) - f(x)}{\phi(x+h) - \phi(x)} = k,$$

<sup>3</sup>The theorems of this section are to be used in § 6 of Chap. VII.



then

$$L_{x \doteq \infty} \frac{f(x)}{\phi(x)}$$

exists and is equal to  $k$ .<sup>4</sup>

**Proof.** Let  $V_1(k)$  and  $V_2(k)$  be a pair of vicinities of  $k$  such that  $V_2(k)$  is entirely within  $V_1(k)$ . By hypothesis there exists an  $h$  and an  $X_2$  such that if  $x > X_2$ ,

$$\frac{f(x+h) - f(x)}{\phi(x+h) - \phi(x)} \quad (1)$$

is in  $V_2(k)$ . Since this is true for every  $x > X_2$ ,

$$\frac{f(x+2h) - f(x+h)}{\phi(x+2h) - \phi(x+h)} \quad (2)$$

is also in  $V_2(k)$ . From this it follows by means of the lemma that

$$\frac{f(x+2h) - f(x)}{\phi(x+2h) - \phi(x)}, \quad (3)$$

whose value is between the values of (1) and (2), is also in  $V_2(k)$ . By repeating this argument we have that for every integral value of  $n$ , and for every  $x > X_2$ ,

$$\frac{f(x+nh) - f(x)}{\phi(x+nh) - \phi(x)}$$

is in  $V_2(k)$ .

By Theorem 65, for any  $x$

$$L_{n \doteq \infty} \frac{f(x+nh) - f(x)}{\phi(x+nh) - \phi(x)} = \frac{f(x)}{\phi(x)}.$$

Hence for every  $x$  and for every  $\varepsilon$  there exists a value of  $n$ ,  $N_{x\varepsilon}$ , such that if  $n > N_{x\varepsilon}$ ,

$$\left| \frac{f(x+nh) - f(x)}{\phi(x+nh) - \phi(x)} - \frac{f(x)}{\phi(x)} \right| < \varepsilon.$$

Taking  $\varepsilon$  less than the distance between the nearest end-points of  $V_1(k)$  and  $V_2(k)$  it is plain that for every  $x > X_2$ ,  $\frac{f(x)}{\phi(x)}$  is on  $V_1(k)$ , which, according to Theorem 26, proves that

$$L_{x \doteq \infty} \frac{f(x)}{\phi(x)} = k.$$

---

<sup>4</sup>This and the following theorem are due to O. STOLZ, who generalized them from the special cases (stated in our corollaries) due to CAUCHY. See STOLZ und GMEINER, Functionentheorie, Vol. 1, p. 31. See also the reference to BORTOLOTTI given on page 82.

*Corollary.*—If  $[n]$  is the set of all positive integers and  $\phi(n+1) < \phi(n)$  and  $f(n)$  and  $\phi(n)$  are both infinitesimal as  $n \doteq \infty$ , then if

$$L_{n \doteq \infty} \frac{f(n+1) - f(n)}{\phi(n+1) - \phi(n)} = k,$$

it follows that  $L_{n \doteq \infty} \frac{f(n)}{\phi(n)}$  exists and is equal to  $k$ .

**Theorem 69.** *If  $f(x)$  is bounded on every finite interval of a certain  $V(+\infty)$ , and if  $\phi(x)$  is monotonic on the same  $V(+\infty)$  and  $L_{x \doteq \infty} \phi(x) = +\infty$ , and if for some positive number  $h$*

$$L_{x \doteq \infty} \frac{f(x+h) - f(x)}{\phi(x+h) - \phi(x)} = k,$$

then

$$L_{x \doteq \infty} \frac{f(x)}{\phi(x)}$$

exists and is equal to  $k$ .

**Proof.** By hypothesis, for every pair of vicinities  $V_1(k)$  and  $V_2(k)$ ,  $V_2(k)$  entirely within  $V_1(k)$ , there exists an  $X_2$  such that if  $x > X_2$ , then

$$\frac{f(x+h) - f(x)}{\phi(x+h) - \phi(x)}$$

is in  $V_2(k)$ . From this it follows as in the last theorem that

$$\frac{f(x+nh) - f(x)}{\phi(x+nh) - \phi(x)}$$

is in  $V_2(k)$ . Now make use of the identity

$$\begin{aligned} \frac{f(x+nh)}{\phi(x+nh)} &= \frac{f(x+nh) - f(x)}{\phi(x+nh)} + \frac{f(x)}{\phi(x+nh)} \\ &= \frac{f(x+nh) - f(x)}{\phi(x+nh) - \phi(x)} \left(1 - \frac{\phi(x)}{\phi(x+nh)}\right) + \frac{f(x)}{\phi(x+nh)}. \end{aligned} \quad (1)$$

Let  $[x']$  be the set of all points on the interval  $\overline{X_2 \ X_2 + h}$ , and for this interval let  $A_2$  be an upper bound of  $|f(x')|$  and  $B_2$  an upper bound of  $\phi(x')$ . Then

$$\frac{\phi(x')}{\phi(x'+nh)} = \varepsilon_1(x', n) < \frac{B_2}{\phi(X_2 + nh)}$$

and

$$\frac{|f(x')|}{\phi(x'+nh)} = \varepsilon_2(x', n) < \frac{A_2}{\phi(X_2 + nh)}.$$

Hence for every  $\varepsilon$  there exists a value of  $n$ ,  $N_{\varepsilon_V}$ , such that if  $n > N_{\varepsilon_V}$

$$\varepsilon_1(x', n) < \varepsilon \quad \text{and} \quad \varepsilon_2(x', n) < \varepsilon \quad (2)$$

independently of  $x'$  so long as  $x'$  is on  $\overline{X_2 \ X_2 + h}$ .

There are then three cases to discuss:

$$(1) \ k \text{ finite.} \quad (2) \ k = +\infty. \quad (3) \ k = -\infty.$$

(1) *k finite.* By the preceding argument, for  $x > X_2$ ,

$$\frac{f(x + nh) - f(x)}{\phi(x + nh) - \phi(x)}$$

is in  $V_2(k)$ , and hence

$$\frac{|f(x' + nh) - f(x')|}{\phi(x' + nh) - \phi(x')} < K + \varepsilon_{V_2},$$

where  $\varepsilon_{V_2}$ , is the length of the interval  $V_2(k)$  and  $K$  the absolute value of  $k$ .

Then, in view of (1),

$$\left| \frac{f(x' + nh)}{\phi(x' + nh)} - \frac{f(x' + nh) - f(x')}{\phi(x' + nh) - \phi(x')} \right| < (K + \varepsilon_{V_2})\varepsilon_1(x', n) + \varepsilon_2(x', n).$$

Now take  $\varepsilon_V$  smaller in absolute value than the length of the interval between the closer end-points of  $V_1(k)$  and  $V_2(k)$ . By (2) there exists a value of  $n$ ,  $N_{\varepsilon_V}$ , such that if  $n > N_{\varepsilon_V}$ ,

$$\varepsilon_1(x', n) < \frac{\varepsilon_V}{2(K + \varepsilon_{V_2})}$$

and

$$\varepsilon_2(x', n) < \frac{\varepsilon_V}{2}$$

for all values of  $x'$  on  $\overline{X_2 \ X_2 + h}$ .

Hence for  $n > N_{\varepsilon_V}$

$$\left| \frac{f(x' + nh)}{\phi(x' + nh)} - \frac{f(x' + nh) - f(x')}{\phi(x' + nh) - \phi(x')} \right| < (K + \varepsilon_{V_2})\frac{\varepsilon_V}{2(K + \varepsilon_{V_2})} + \frac{\varepsilon_V}{2} = \varepsilon_V,$$

and since for  $x > X_2 + N_{\varepsilon_V}h$  there is an  $n > N_{\varepsilon_V}$  and an  $x'$  between  $X_2$  and  $X_2 + h$  such that

$$x' + nh = x,$$

it follows that if  $x > X_2 + N_{\varepsilon_V}h$ ,

$$\left| \frac{f(x)}{\phi(x)} - \frac{f(x' + nh) - f(x')}{\phi(x' + nh) - \phi(x')} \right| < \varepsilon_V,$$

and therefore,  $\frac{f(x)}{\phi(x)}$  is on  $V_1(k)$ .

This means, according to Theorem 26, that

$$L_{x \rightarrow \infty} \frac{f(x)}{\phi(x)} = k.$$

(2)  $k = +\infty$ .

If the numbers  $m_1$  and  $m_2$  are the lower end points of  $V_1(k)$  and  $V_2(k)$ , then

$$\frac{f(x' + nh) - f(x')}{\phi(x' + nh) - \phi(x')} > m_2 \quad \text{for } x' > X_2.$$

If  $\varepsilon_V$  is then chosen less than  $m_2 - m_1$ , there will exist a value of  $N_{\varepsilon_V}$  such that

$$\varepsilon_1(x', n) < \frac{\varepsilon_V}{2m_2} \quad \text{and} \quad \varepsilon_2(x', n) < \frac{\varepsilon_V}{2m_1}$$

for all values of  $n > N_{\varepsilon_V}$  independently of  $x'$  so long as  $x'$  is in  $\overline{X_2, X_2 + h}$ . Then, in view of (1),

$$\frac{f(x' + nh)}{\phi(x' + nh)} > m_2 \left(1 - \frac{\varepsilon_V}{2m_2}\right) - \frac{\varepsilon_V}{2m_2} > m_2 - \frac{\varepsilon_V}{2} \left(1 + \frac{1}{m_2}\right).$$

Since there is no loss of generality if  $m_2 > +1$ , this proves that for  $x > X_2 + N_{\varepsilon_V}n$ ,

$$\frac{f(x)}{\phi(x)} > m_2 - \varepsilon_V > m_1,$$

and hence  $\frac{f(x)}{\phi(x)}$  is on  $V_1(k)$ .

(3)  $k = -\infty$  is treated in an analogous manner.

*Corollary 1.* If  $[n]$  is the set of all positive integers and if

$$\phi(n+1) > \phi(n) \quad \text{and} \quad L_{n \rightarrow \infty} \phi(n) = \infty,$$

then if

$$L_{n \rightarrow \infty} L \frac{f(n+1) - f(n)}{\phi(n+1) - \phi(n)} = k,$$

it follows that  $L_{n \rightarrow \infty} \frac{f(n)}{\phi(n)}$  exists and is equal to  $k$ .

*Corollary 2.* If  $f(x)$  is bounded on every interval,  $\overline{x, x+1}$ , and if

$$L_{x \rightarrow \infty} f(x+1) - f(x) = k,$$

then

$$L_{x \rightarrow \infty} \frac{f(x)}{x}$$

exists and is equal to  $k$ .

## § 4 Rank of Infinitesimals and Infinites.

**Definition.**—If on some  $V^*(a)$  neither  $f_1(x)$  nor  $f_2(x)$  vanishes, and  $\left| \frac{f_1(x)}{f_2(x)} \right|$  and  $\left| \frac{f_2(x)}{f_1(x)} \right|$  are both bounded as  $x$  approaches  $a$ , then  $f_1(x)$  and  $f_2(x)$  are of the same *rank* whether  $L \frac{f_1(x)}{f_2(x)}_{x \rightarrow a}$  exists or not.<sup>5</sup>

The following theorem is obvious.

**Theorem 70.** *If  $f_1(x)$  and  $f_2(x)$  are of the same order, they are of the same rank, and if  $f_1(x)$  and  $f_2(x)$  are of different orders, they are not of the same rank. If  $f_1(x)$  and  $f_2(x)$  are of the same rank, they may or may not be of the same order.*

**Theorem 71.** *If  $f_1(x)$  and  $f_2(x)$  are of the same rank as  $x$  approaches  $a$ , then  $c \cdot f_1(x)$  and  $f_2(x)$  are of the same rank,  $c$  being any constant not zero.*

**Proof.** By hypothesis for some positive number  $M$ ,

$$\left| \frac{f_1(x)}{f_2(x)} \right| < M \text{ and } \left| \frac{f_2(x)}{f_1(x)} \right| < M,$$

hence

$$\left| \frac{c \cdot f_1(x)}{f_2(x)} \right| < M \cdot |c| \text{ and } \left| \frac{f_2(x)}{c \cdot f_1(x)} \right| < \frac{M}{|c|}.$$

**Theorem 72.** *If  $f_1(x)$  and  $f_2(x)$  are of the same rank and  $f_2(x)$  and  $f_3(x)$  are of the same rank as  $x$  approaches  $a$ , then  $f_1(x)$  and  $f_3(x)$  are of the same rank as  $x$  approaches  $a$ .*

**Proof.** By hypothesis,

$$\left| \frac{f_1(x)}{f_2(x)} \right| < M_1 \text{ and } \left| \frac{f_2(x)}{f_3(x)} \right| < M_2$$

in some neighborhood of  $x = a$ . Therefore

$$\left| \frac{f_1(x)}{f_2(x)} \right| \cdot \left| \frac{f_2(x)}{f_3(x)} \right| < M_1 \cdot M_2 \text{ or } \left| \frac{f_1(x)}{f_3(x)} \right| < M_1 \cdot M_2.$$

In the same manner

$$\left| \frac{f_2(x)}{f_1(x)} \right| < M_1 \text{ and } \left| \frac{f_3(x)}{f_2(x)} \right| < M_2, \text{ whence } \left| \frac{f_3(x)}{f_1(x)} \right| < M_1 \cdot M_2.$$

---

<sup>5</sup> $x$  and  $x \cdot (\sin \frac{1}{x} + 2)$  are of the same rank but not of the same order as  $x$  approaches zero.

**Theorem 73.** *If  $f_1(x)$  is infinitesimal (infinite) and does not vanish on some  $V^*(a)$ , and if  $f_2(x)$  and  $f_3(x)$  are infinitesimal (infinite) of the same rank as  $x$  approaches  $a$ , then  $f_1(x) \cdot f_2(x)$  is of higher order than  $f_3(x)$ , and  $f_1(x) \cdot f_3(x)$  is of higher order than  $f_2(x)$ . Conversely, if for every function,  $f_1(x)$ , infinitesimal (infinite) at  $a$ ,  $f_1(x) \cdot f_2(x)$  is of higher order than  $f_3(x)$ , and  $f_1(x) \cdot f_3(x)$  is of higher order than  $f_2(x)$ , then  $f_2(x)$  and  $f_3(x)$  are of the same rank.*

**Proof.** Since  $\left| \frac{f_1(x)}{f_3(x)} \right|$  is bounded as  $x$  approaches  $a$ , it follows by Theorem 33 that

$$\underset{x \dot{=} a}{L} \frac{f_1(x) \cdot f_2(x)}{f_3(x)} = 0,$$

which proves the first part of the theorem.

Since likewise  $\left| \frac{f_3(x)}{f_2(x)} \right|$  is bounded, we have that

$$\underset{x \dot{=} a}{L} \frac{f_1(x) \cdot f_3(x)}{f_2(x)} = 0.$$

Suppose that for every  $f_1(x)$

$$\underset{x \dot{=} a}{L} \frac{f_1(x) \cdot f_2(x)}{f_3(x)} = 0 \text{ and } \underset{x \dot{=} a}{L} \frac{f_1(x) \cdot f_3(x)}{f_2(x)} = 0,$$

and that  $f_2(x)$  and  $f_3(x)$  are not of the same rank. Then, on a certain subset  $[x']$ ,  $\underset{x \dot{=} a}{L} \frac{f_2(x')}{f_3(x')} = 0$ , or on some other subset  $[x'']$ ,  $\underset{x \dot{=} a}{L} \frac{f_3(x'')}{f_2(x'')} = 0$ . Let  $f_1(x) = \frac{f_2(x)}{f_3(x)}$  on the set  $[x']$  for which  $\underset{x \dot{=} a}{L} \frac{f_2(x)}{f_3(x)} = 0$ , and  $x - a$  on the other points of the continuum; then  $f_1(x)$  is an infinitesimal as  $x$  approaches  $a$ , while for the set  $[x']$

$$\underset{x \dot{=} a}{L} \frac{f_1(x') \cdot f_3(x')}{f_3(x')} = \underset{x \dot{=} a}{L} \frac{f_2(x')}{f_3(x')} \cdot \frac{f_3(x')}{f_2(x')} = 1,$$

which contradicts the hypothesis that

$$\underset{x \dot{=} a}{L} \frac{f_1(x) \cdot f_3(x)}{f_2(x)} = 0.$$

Similarly if on a certain subset  $\underset{x \dot{=} a}{L} \frac{f_3(x)}{f_2(x)} = 0$ , we obtain a contradiction by putting  $f_1(x) = \frac{f_3(x)}{f_2(x)}$ .

# Chapter 7

## DERIVATIVES AND DIFFERENTIALS.

### § 1 Definition and Illustration of Derivatives.

**Definition.**—If the ratio  $\frac{f(x)-f(x_1)}{x-x_1}$  approaches a definite limit, finite or infinite, as  $x$  approaches  $x_1$ , the *derivative* of  $f(x)$  at the point  $x_1$  is the limit

$$\lim_{x \rightarrow x_1} \frac{f(x) - f(x_1)}{x - x_1}.$$

It is implied that the function  $f(x)$  is a single-valued function of  $x$ .  $x - x_1$  is sometimes denoted by  $\Delta x_1$ , and  $f(x) - f(x_1)$  by  $\Delta f(x_1)$ , or, if  $y = f(x)$ , by  $\Delta y_1$ .

An obvious illustration of a derivative occurs in Cartesian geometry when the function is represented by a graph (Fig. 14).  $\frac{f(x)-f(x_1)}{x-x_1}$  is the slope of the line  $AB$ . If we suppose that the line  $AB$  approaches a fixed direction (which in this figure would obviously be the case) as  $x$  approaches  $x_1$ , then  $\lim_{x \rightarrow x_1} \frac{f(x) - f(x_1)}{x - x_1}$  will exist and will be equal to the slope of the limiting position of  $AB$ .

If the point  $x$  were taken only on one side of  $x_1$ , we should have two similar limiting processes. It is quite conceivable, however, that limits should exist on each side, but that they should differ. That case occurs if the graph has a cusp as in Fig. 15.

These two cases are distinguished by the terms progressive and regressive derivatives. When the independent variable approaches its limit from below we speak of the progressive derivative, and when from above we speak of the regressive derivative. It follows from the definition of derivative that, except in one singular case, it exists only when both these limits exist and are equal. The exception is the case of a derivative of a function at an end-point of an interval upon which the function is defined. Obviously both the progressive and the regressive derivative cannot exist at such a point. In this case we say the derivative exists if either the progressive or the regressive derivative exists.

Whether the progressive and regressive derivatives exist or not, there exist always four so-called derived numbers (which may be  $\pm\infty$ ), namely, the upper and lower bounds of

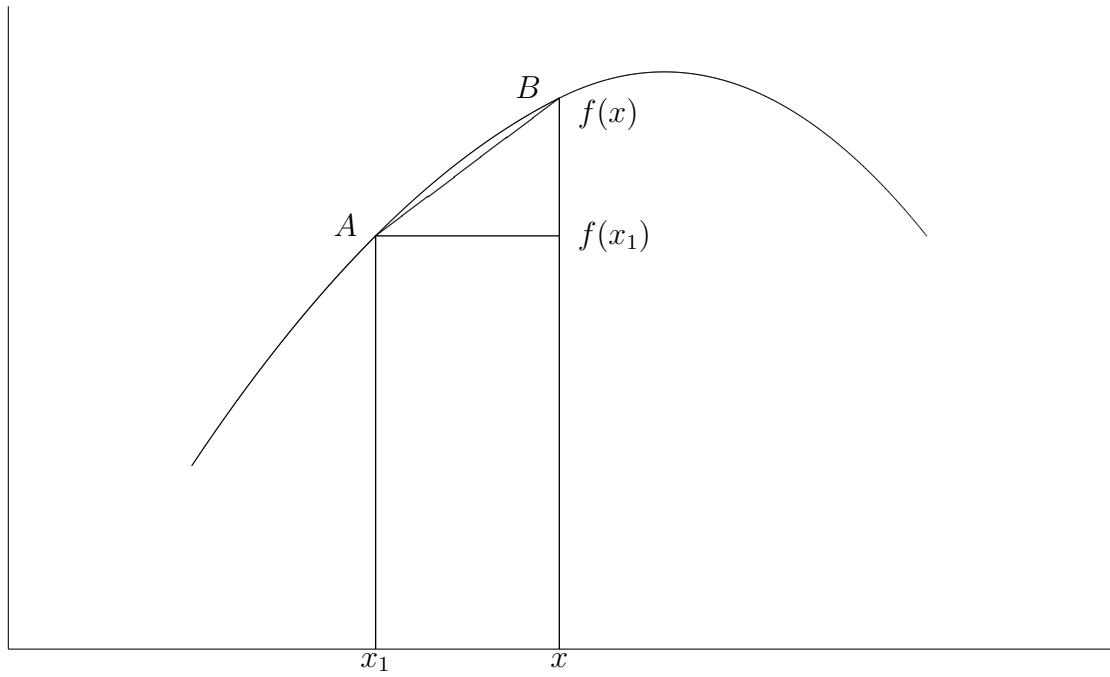

FIG. 14.

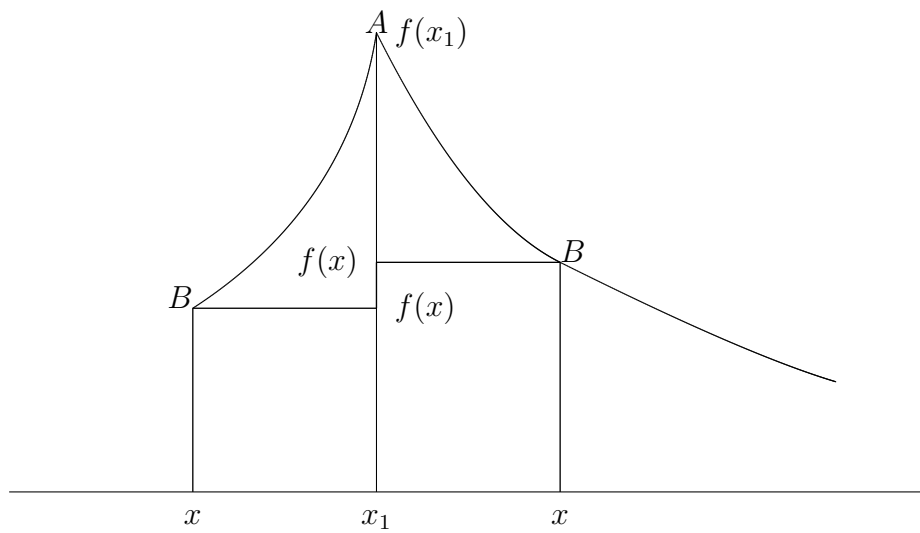

FIG. 15.



indetermination of

$$\frac{f(x) - f(x_1)}{x - x_1},$$

as  $x \doteq x_1$  from the right or from the left. (Compare page 65, Chapter IV.) The derived numbers are denoted by the symbols.

$$\vec{D}, \underline{D}, \overleftarrow{D}, \overleftarrow{D},$$

analogous to the symbols on page 65. Of course, in every case,

$$\vec{D} \geq \underline{D} \text{ and } \overleftarrow{D} \geq \overleftarrow{D}.$$

If we consider the curve representing the function

$$y = x \cdot \sin \frac{1}{x}$$

at the point  $x = 0$ , it is apparent that the limiting position of  $AB$  does not exist, although the function is continuous at the point  $x = 0$  if defined as zero for  $x = 0$ . For at every maximum and minimum of the curve  $\sin \frac{1}{x}$ ,  $x \cdot \sin \frac{1}{x} = \pm x$ , and the curve touches the lines  $x = y$  and  $x = -y$ . That is,  $\frac{f(x) - f(x_1)}{x - x_1}$  approaches every value between 1 and  $-1$  inclusive, as  $x$  approaches zero.

The notion *derivative* is fundamental in physics as well as in geometry. If, for instance, we consider the motion of a body, we may represent its distance from a fixed point as a function of time,  $f(t)$ . At a certain instant of time  $t_1$  its distance from the fixed point is  $f(t_1)$ , and at another instant  $t_2$  it is  $f(t_2)$ ; then

$$\frac{f(t_1) - f(t_2)}{t_1 - t_2}$$

is the average velocity of the body during the interval of time  $t_1 - t_2$  in a direction from or toward the assumed fixed point. Whether the motion be from or toward the fixed point is of course indicated by the sign of the expression  $\frac{f(t_1) - f(t_2)}{t_1 - t_2}$ . If we consider this ratio as the time interval is taken shorter and shorter, that is, as  $t_2$  approaches  $t_1$ , it will in ordinary physical motion approach a perfectly definite limit. This limit is spoken of as the velocity of the body at the instant  $t_1$ .

**Definition.**—The derivative of a function  $y = f(x)$  is denoted by  $f'(x)$  or by  $D_x f(x)$  or  $\frac{df(x)}{dx}$  or  $\frac{dy}{dx}$ .  $f'(x)$  is also referred to as the *derived function* of  $f(x)$ .

## § 2 Formulas of Differentiation.

**Theorem 74.** *The derivative of a constant is zero. More precisely: If there exists a neighborhood of  $x_1$  such that for every value of  $x$  on this neighborhood  $f(x) = f(x_1)$ , then  $f'(x_1) = 0$ .*

**Proof.** In the neighborhood specified  $\frac{f(x)-f(x_1)}{x-x_1} = 0$  for every value of  $x$ .

*Corollary.*—If  $f'(x_1)$  exists and if in every  $V^*(x_1)$  there is a value of  $x$  such that  $f(x) = f(x_1)$ , then  $f'(x_1) = 0$ .

**Theorem 75.** *When for two functions  $f_1(x)$  and  $f_2(x)$  the derived functions  $f_1'(x)$  and  $f_2'(x)$  exist at  $x_1$  it follows that, except in the indeterminate case  $\infty - \infty$ ,*

(a) *If  $f_3(x) = f_1(x) + f_2(x)$ , then  $f_3(x)$  has a derivative at  $x_1$  and*

$$f_3'(x_1) = f_1'(x_1) + f_2'(x_1).$$

(b) *If  $f_3(x) = f_1(x) \cdot f_2(x)$ , then  $f_3(x)$  has a derivative at  $x_1$  and*

$$f_3'(x_1) = f_1'(x_1) \cdot f_2(x_1) + f_1(x_1) \cdot f_2'(x_1).$$

(c) *If  $f_3(x) = \frac{f_1(x)}{f_2(x)}$ , then, provided there is a  $V(x_1)$  upon which  $f_2(x) \neq 0$ ,  $f_3(x)$  has a derivative and*

$$f_3'(x_1) = \frac{f_1'(x_1) \cdot f_2(x_1) - f_1(x_1) \cdot f_2'(x_1)}{\{f_2(x_1)\}^2}.$$

**Proof.** By definition and the theorems of Chapter IV (which exclude the case  $\infty - \infty$ ),

(a)

$$f_1'(x_1) + f_2'(x_1) = \lim_{x \rightarrow x_1} \frac{f_1(x) - f_1(x_1)}{x - x_1} + \lim_{x \rightarrow x_1} \frac{f_2(x) - f_2(x_1)}{x - x_1} \quad (1)$$

$$= \lim_{x \rightarrow x_1} \left\{ \frac{f_1(x) - f_1(x_1)}{x - x_1} + \frac{f_2(x) - f_2(x_1)}{x - x_1} \right\} \quad (2)$$

$$= \lim_{x \rightarrow x_1} \frac{f_1(x) + f_2(x) - f_1(x_1) - f_2(x_1)}{x - x_1} \quad (3)$$

$$= \lim_{x \rightarrow x_1} \frac{f_3(x) - f_3(x_1)}{x - x_1}.$$

But by definition,

$$f_3'(x_1) = \lim_{x \rightarrow x_1} \frac{f_3(x) - f_3(x_1)}{x - x_1}. \quad (4)$$

Hence  $f_3'(x_1)$  exists, and  $f_3'(x_1) = f_1'(x_1) + f_2'(x_1)$ .

(b)  $f_3(x) = f_1(x) \cdot f_2(x)$ .

Whenever  $x \neq x_1$  we have the identity

$$\begin{aligned} \frac{f_3(x) - f_3(x_1)}{x - x_1} &= \frac{f_1(x) \cdot f_2(x) - f_1(x_1) \cdot f_2(x_1)}{x - x_1} \\ &= \frac{f_1(x) \cdot f_2(x) - f_1(x_1) \cdot f_2(x) + f_1(x_1) \cdot f_2(x) - f_1(x_1) \cdot f_2(x_1)}{x - x_1} \\ &= f_2(x) \left\{ \frac{f_1(x) - f_1(x_1)}{x - x_1} \right\} + f_1(x_1) \left\{ \frac{f_2(x) - f_2(x_1)}{x - x_1} \right\}. \end{aligned}$$

But the limit of the last expression exists as  $x \doteq x_1$  (except perhaps in the case  $\infty - \infty$ ) and is equal to

$$f_2(x_1) \cdot f_1'(x_1) + f_1(x_1) \cdot f_2'(x_1).$$

Hence

$$\lim_{x \doteq x_1} \frac{f_3(x) - f_3(x_1)}{x - x_1}$$

exists and

$$f_3'(x_1) = f_2(x_1) \cdot f_1'(x_1) + f_2'(x_1) \cdot f_1(x_1).$$

(c)

$$f_3(x) = \frac{f_1(x)}{f_2(x)}.$$

The argument is based on the identity

$$\frac{\frac{f_1(x)}{f_2(x)} - \frac{f_1(x_1)}{f_2(x_1)}}{x - x_1} = \frac{f_1(x) \cdot f_2(x_1) - f_2(x) \cdot f_1(x_1)}{f_2(x) \cdot f_2(x_1) \cdot (x - x_1)},$$

which holds when  $x \neq x_1$  and when  $f_2(x) \neq 0$ . But

$$\begin{aligned} & \frac{f_1(x) \cdot f_2(x_1) - f_2(x) \cdot f_1(x_1)}{f_2(x) \cdot f_2(x_1)(x - x_1)} \\ &= \frac{f_1(x) \cdot f_2(x_1) - f_1(x_1) \cdot f_2(x_1) + f_1(x_1) \cdot f_2(x_1) - f_2(x) \cdot f_1(x_1)}{f_2(x) \cdot f_2(x_1)(x - x_1)} \\ &= \frac{f_2(x_1) \{f_1(x) - f_1(x_1)\} - f_1(x_1) \{f_2(x) - f_2(x_1)\}}{f_2(x) \cdot f_2(x_1)(x - x_1)}. \end{aligned}$$

As before (excluding the case  $\infty - \infty$ ) we have

$$f_3'(x_1) = \frac{f_2(x_1) \cdot f_1'(x_1) - f_2'(x_1) \cdot f_1(x_1)}{\{f_2(x_1)\}^2}.$$

*Corollary.*—It follows from Theorems 74 and 75 of this chapter that if  $f_2(x) = a \cdot f_1(x)$  where  $f_1'(x)$  exists, then

$$f_2'(x) = a \cdot f_1'(x).$$

**Theorem 76.** *If  $x > 0$ , then  $\frac{d}{dx}x^k = k \cdot x^{k-1}$ .*

(a) If  $k$  is a positive integer, we have

$$\begin{aligned} \lim_{x \doteq x_1} \frac{x^k - x_1^k}{x - x_1} &= \lim_{x \doteq x_1} \{x^{k-1} + x^{k-2} \cdot x_1 + \dots + x^k \cdot x_1^{k-2} + x_1^{k-1}\} \\ &= k \cdot x_1^{k-1}. \end{aligned}$$

(b) If  $k$  is a positive rational fraction  $\frac{m}{n}$ , we have

$$\begin{aligned} L_{x \dot{=} x_1} \frac{x^{\frac{m}{n}} - x_1^{\frac{m}{n}}}{x - x_1} &= L_{x \dot{=} x_1} \frac{\left(x^{\frac{1}{n}}\right)^m - \left(x_1^{\frac{1}{n}}\right)^m}{\left(x^{\frac{1}{n}}\right)^n - \left(x_1^{\frac{1}{n}}\right)^n} \\ &= L_{x \dot{=} x_1} \frac{1}{\left(x^{\frac{1}{n}}\right)^{n-1} + \left(x^{\frac{1}{n}}\right)^{n-2} \cdot \left(x_1^{\frac{1}{n}}\right) + \dots + \left(x_1^{\frac{1}{n}}\right)^{n-1}} \cdot \frac{\left(x^{\frac{1}{n}}\right)^m - \left(x_1^{\frac{1}{n}}\right)^m}{x^{\frac{1}{n}} - x_1^{\frac{1}{n}}} \\ &= \frac{1}{n \cdot \left(x_1^{\frac{1}{n}}\right)^{n-1}} \cdot m \left(x_1^{\frac{1}{n}}\right)^{m-1}, \end{aligned}$$

by the preceding case.

But

$$\frac{1}{n \cdot \left(x_1^{\frac{1}{n}}\right)^{n-1}} \cdot m \left(x_1^{\frac{1}{n}}\right)^{m-1} = \frac{m}{n} x_1^{\frac{m}{n}-1} = k \cdot x_1^{k-1}.$$

(c) If  $k$  is a negative rational number and equal to  $-m$ , then, by the two preceding cases,

$$\begin{aligned} L_{x \dot{=} x_1} \frac{x^{-m} - x_1^{-m}}{x - x_1} &= - L_{x \dot{=} x_1} \frac{1}{x^m \cdot x_1^m} \cdot \frac{x^m - x_1^m}{x - x_1} = -\frac{1}{x_1^{2m}} \cdot m x_1^{m-1} \\ &= -m x_1^{-m-1}. \quad \square \end{aligned}$$

But

$$-m x_1^{-m-1} = k \cdot x_1^{k-1}.$$

(d) If  $k$  is a positive irrational number, we proceed as follows:

Consider values of  $x$  greater than or equal to unity. Let  $x$  approach  $x_1$  so that  $x > x_1$ . Since, by Theorem 23,  $x^k$  is a monotonic increasing function of  $k$  for  $x > 1$ , it follows that

$$\frac{x^k - x_1^k}{x - x_1} = x_1^k \cdot \frac{\left(\frac{x}{x_1}\right)^k - 1}{x - x_1} > x_1^{k'} \cdot \frac{\left(\frac{x}{x_1}\right)^{k'} - 1}{x - x_1}$$

for all values of  $k'$  less than  $k$ , and all values of  $x$  greater than  $x_1$ . If  $k'$  is a rational number, we have by the preceding cases that

$$L_{x \dot{=} x_1} x_1^{k'} \cdot \frac{\left(\frac{x}{x_1}\right)^{k'} - 1}{x - x_1} = k' x_1^{k'-1}.$$

Since  $x_1^{k-1}$  is a continuous function of  $k$ , it follows that for every number  $N$  less than  $k x_1^{k-1}$  there exists a rational number  $k'_1$  less than  $k$  such that

$$N < k'_1 \cdot x_1^{k'_1-1} < k \cdot x_1^{k-1}.$$

Hence, by Theorem 40,

$$x_1^k \cdot \frac{\left(\frac{x}{x_1}\right)^k - 1}{x - x_1}$$

cannot approach a value  $N$  less than  $kx_1^{k-1}$  as  $x$  approaches  $x_1$ .

By a precisely similar argument we show that a number greater than  $kx_1^{k-1}$  cannot be a value approached. Since there is always at least one value approached, we have that

$$L_{x \doteq x_1} \frac{x^k - x_1^k}{x - x_1} = k \cdot x_1^{k-1}.$$

If  $x < x_1$  as  $x$  approaches  $x_1$ , we write

$$\frac{x^k - x_1^k}{x - x_1} = x^k \cdot \frac{\left(\frac{x_1}{x}\right)^k - 1}{x_1 - x}$$

and proceed as before. If  $k$  is a negative number we proceed as under (c). The case in which  $x_1 < 1$  is treated similarly. For another proof see page 102.

**Theorem 77.**  $\frac{d}{dx} \log_a x = \frac{1}{x} \cdot \log_a e$ .

**Proof.**

$$\begin{aligned} \frac{\log_a(x + \Delta x) - \log_a x}{\Delta x} &= \frac{1}{\Delta x} \log_a \frac{x + \Delta x}{x} \\ &= \frac{1}{x} \cdot \log_a \left(1 + \frac{\Delta x}{x}\right)^{\frac{x}{\Delta x}}. \end{aligned}$$

But, by Theorem 57,

$$L_{\Delta x \doteq 0} \left(1 + \frac{\Delta x}{x}\right)^{\frac{x}{\Delta x}} = e.$$

Therefore

$$L_{\Delta x \doteq 0} \frac{\log_a(x + \Delta x) - \log_a x}{\Delta x} = \frac{1}{x} \cdot \log_a e.$$

*Corollary.*—

$$\frac{d}{dx} \log_a x = \frac{1}{x}.$$

**Theorem 78.** If  $f_1'(x)$  exists and if there is a  $V(x_1)$  upon which  $f_1(x)$  is continuous and possesses a single-valued inverse  $x = f_2(y)$ , then  $f_2(y)$  is differentiable and

$$f_1'(x_1) = \frac{1}{f_2'(y_1)}, \text{ where } y_1 = f_1(x_1).^1$$

<sup>1</sup>Theorem 78 gives a sufficient condition for the equality

$$\frac{dy}{dx} = \frac{1}{\frac{dx}{dy}}.$$

If  $f'(x)$  is 0 or  $+\infty$  or  $-\infty$  the convention  $\frac{1}{+\infty} = \frac{1}{-\infty} = 0$  is understood. Cf. Theorem 37.

**Proof.** To prove this theorem we observe that

$$f'_1(x_1) = \underset{x \dot{=} x_1}{L} \frac{f_1(x) - f_1(x_1)}{x - x_1} = \underset{x \dot{=} x_1}{L} \frac{1}{\frac{x-x_1}{f_1(x)-f_1(x_1)}}.$$

By the definition of single-valued inverse (p. 34),

$$\frac{x - x_1}{f_1(x) - f_1(x_1)} = \frac{f_2(y) - f_2(y_1)}{y - y_1}.$$

Hence, by Theorems 38 and 34 and 37,

$$\underset{x \dot{=} x_1}{L} \frac{1}{\frac{x-x_1}{f_1(x)-f_1(x_1)}} = \underset{y \dot{=} y_1}{L} \frac{1}{\frac{f_2(y)-f_2(y_1)}{y-y_1}} = \frac{1}{f'_2(y)}.$$

**Theorem 79.** *If*

- (1)  $f'_1(x)$  exists and is finite for  $x = x_1$ , and  $f_1(x)$  is continuous at  $x = x_1$ ,
- (2)  $f'_2(y)$  exists and is finite for  $y_1 = f_1(x_1)$ ,

then

$$\frac{d}{dx_1} f_2\{f_1(x_1)\} = f'_2(y_1) \cdot f'_1(x_1).^2$$

**Proof.** We prove this theorem first for the case when there is a  $V^*(x_1)$  upon which  $f_1(x) \neq f_1(x_1)$ . In this case the following is an identity in  $x$ :

$$\frac{f_2\{f_1(x)\} - f_2\{f_1(x_1)\}}{x - x_1} = \frac{f_2\{f_1(x)\} - f_2\{f_1(x_1)\}}{f_1(x) - f_1(x_1)} \cdot \frac{f_1(x) - f_1(x_1)}{x - x_1}. \quad (1)$$

By hypothesis (2) and Theorem 38,

$$f'_2(y_1) = \underset{y \dot{=} y_1}{L} \frac{f_2(y) - f_2(y_1)}{y - y_1} = \underset{x \dot{=} x_1}{L} \frac{f_2\{f_1(x)\} - f_2\{f_1(x_1)\}}{f_1(x) - f_1(x_1)}.$$

By hypothesis (1),

$$f'_1(x) = \underset{x \dot{=} x_1}{L} \frac{f_1(x) - f_1(x_1)}{x - x_1}.$$

---

<sup>2</sup>Theorem 79 gives a sufficient condition for the equality

$$\frac{dz}{dx} = \frac{dz}{dy} \frac{dy}{dx}.$$

Hence, by equation (1) and Theorem 34, we have the existence of

$$\frac{d}{dx} f_2\{f_1(x)\} = \underset{x \doteq x_1}{L} \frac{f_2\{f_1(x)\} - f_2\{f_1(x_1)\}}{x - x_1} = f_2'(y_1) \cdot f_1'(x_1).$$

If  $f_1(x) = f_1(x_1)$  for values of  $x$  on every neighborhood of  $x = x_1$ , then, by hypothesis (1) and the corollary of Theorem 74,

$$f_1'(x_1) = 0.$$

Let  $[x']$  be the set of points upon which  $f_1(x) \neq f_1(x_1)$ . (There is such a set unless  $f(x)$  is constant in the neighborhood of  $x = x_1$ .) Then, by the same argument as in the first case, we have

$$\frac{d}{dx'} f_2\{f_1(x_1)\} = f_2'(y_1) \cdot f_1'(x_1) = 0 \text{ for } x \text{ on the set } [x'].$$

Let  $[x'']$  be the set of values of  $x$  not included in  $[x']$ . Then

$$\frac{d}{dx''} f_2\{f_1(x_1)\} = \underset{x'' \doteq x'}{L} \frac{f_2\{f_1(x'')\} - f_2\{f_1(x_1)\}}{x'' - x_1} = 0,$$

since the limitand function is zero. Hence both for the set  $[x']$  and for the set  $[x'']$  the conclusion of our theorem is that the derivative required is zero.

**Theorem 80.**

$$\frac{d}{dx} a^x = a^x \log a.$$

**Proof.** Let

$$y = a^x,$$

therefore

$$\log y = x \cdot \log a$$

and, by Theorem 77,

$$\frac{\frac{dy}{dx}}{y} = \log a,$$

whence

$$\frac{dy}{dx} = y \cdot \log a = a^x \log a.$$

This method also affords an elegant proof of Theorem 76, viz.,

$$\frac{d}{dx}x^n = nx^{n-1}.$$

Let

$$y = x^n,$$

$$\log y = n \log x,$$

$$\frac{dy}{dx} = \frac{n}{x},$$

$$\frac{dy}{dx} = n \cdot \frac{y}{x} = n \cdot x^{n-1}.$$

### § 3 Differential Notations.

If

$$y = f(x) \quad \text{and} \quad \lim_{x \rightarrow a} \frac{f(x) - f(x_1)}{x - x_1} = K,$$

we denote  $f(x) - f(x_1)$  by  $\Delta y$ , and  $x - x_1$  by  $\Delta x$ . Then, by Theorem 31,

$$\Delta y = \Delta x \cdot K + \Delta x \cdot \varepsilon(x),$$

where  $\Delta x \cdot \varepsilon(x)$  is an infinitesimal with respect to  $\Delta y$  and  $\Delta x$  for  $x \rightarrow a$ . This fact is expressed by the equation

$$dy = K \cdot dx, \quad \text{where } K = f'(x).$$

Here  $dy$  and  $dx$  are any numbers that satisfy this equation. There is no condition as to their being small, either expressed or implied, and  $dx$  and  $dy$  may be regarded as variable or constant, large or small, as may be found convenient. When either  $dx$  or  $dy$  is once chosen, the other is, of course, determined. The numbers  $dx$  and  $dy$  are called the differentials of  $x$  and  $y$  respectively.

In Fig. 16,  $f'(x_1)$  is the tangent of the angle  $CAB$ ,  $dx$  is the length of any segment  $\overline{AB}$  with one extremity at  $A$  and parallel to the  $x$ -axis, and  $dy$  is the length of the segment  $\overline{BC}$ . If  $x$  is regarded as approaching  $x_1$ , then  $\overline{AB'}$  is the infinitesimal  $\Delta x$ ,  $\overline{B'D'}$  is  $\Delta y$ , while  $\overline{D'C'}$  is  $\varepsilon(x) \cdot \Delta x$ . Hence, by Theorem 73,  $\overline{D'C'}$  is an infinitesimal of higher order than  $\Delta x$  or  $\Delta y$ .

We thus obtain a complete correspondence between derivatives and the ratios of differentials. Accordingly, for any formula in derivatives there is a corresponding formula in differentials. Thus corresponding to Theorem 75 we have:

**Theorem 81.** *When for two functions  $f_1(x)$  and  $f_2(x)$*

$$df_1(x) = f_1'(x) \cdot dx \quad \text{and} \quad df_2(x) = f_2'(x) \cdot dx \quad \text{at } x_1,$$

*it follows that*



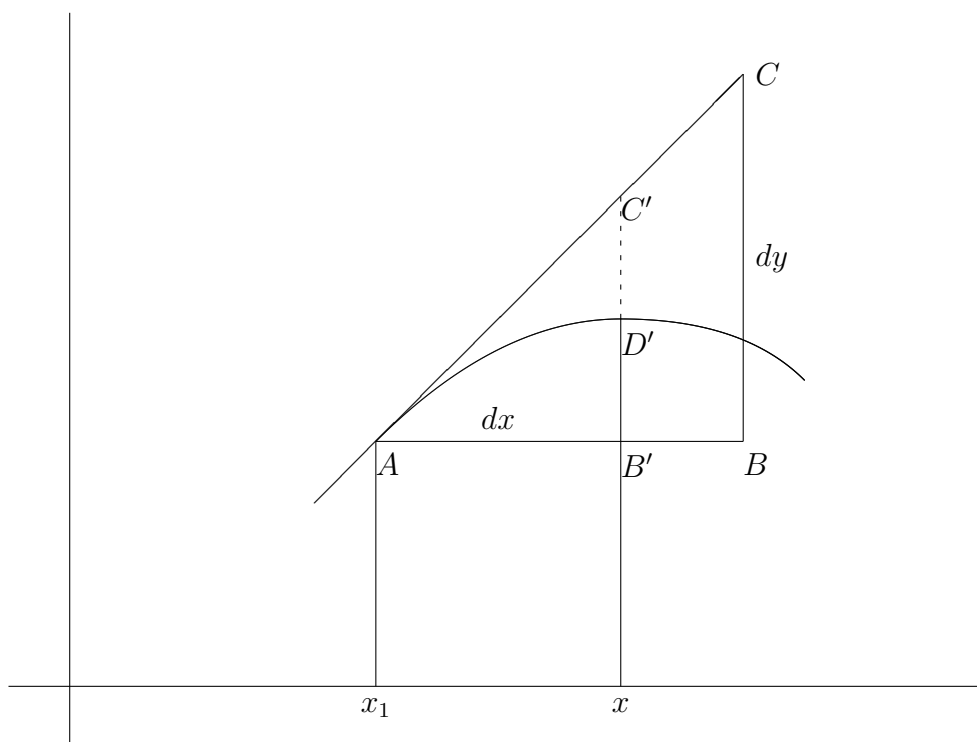

FIG. 16

(a) If  $f_3(x) = f_1(x) + f_2(x)$ , then

$$\begin{aligned} df_3(x_1) &= \{f'_1(x_1) + f'_2(x_1)\}dx \\ &= df_1(x_1) + df_2(x_1). \end{aligned}$$

(b) If  $f_3(x) = f_1(x) - f_2(x)$ , then

$$\begin{aligned} df_3(x_1) &= \{f'_1(x_1) - f'_2(x_1)\}dx \\ &= df_1(x_1) - df_2(x_1). \end{aligned}$$

(c) If  $f_3(x) = f_1(x) \cdot f_2(x)$ , then

$$\begin{aligned} df_3(x_1) &= \{f_1(x_1) \cdot f'_2(x_1) + f_2(x_1) \cdot f'_1(x_1)\} \cdot dx \\ &= f_1(x_1) \cdot df_2(x_1) + f_2(x_1) \cdot df_1(x_1). \end{aligned}$$

(d) If  $f_3(x) = \frac{f_1(x)}{f_2(x)}$ , then

$$\begin{aligned} df_3(x_1) &= \frac{\{f_2(x_1) \cdot f'_1(x_1) - f_1(x_1) \cdot f'_2(x_1)\} \cdot dx}{\{f_2(x_1)\}^2} \\ &= \frac{f_2(x_1) \cdot df_1(x_1) - f_1(x_1)df_2(x_1)}{\{f_2(x_1)\}^2}. \end{aligned}$$

The rule obtained on page 97 et seq. that the derivative of  $x^k$  is  $k \cdot x^{k-1}$  corresponds to the equation  $dx^k = k \cdot x^{k-1} \cdot dx$ . If, in the equation  $dy = f'(x)dx$ ,  $dx$  is regarded as a constant while  $x$  varies, then  $dy$  is a function of  $x$ . We then obtain a differential  $d_2(dy) = \{f''(x) \cdot dx\}d_2x$  in precisely the same manner that we obtain  $dy = f'(x) \cdot dx$ . Since  $d_2x$  may be chosen arbitrarily, we choose it equal to  $dx$ . Hence  $d(dy) = f''(x)dx^2$ . We write this

$$d^2y = f''(x) \cdot dx^2.$$

The *differential coefficient*  $f''(x)$  is clearly identical with the *derivative of*  $f'(x)$ . In this manner we obtain successively

$$d^3y = f^{(3)}(x) \cdot dx^3, \text{ etc.}$$

We may write these results,

$$\frac{dy}{dx} = f'(x), \quad \frac{d^2y}{dx^2} = f''(x), \dots, \quad \frac{d^n y}{dx^n} = f^{(n)}(x).$$

Evidently the existence of the differential coefficient is coextensive with the existence of the derivative.

## § 4 Mean-value Theorems.

**Theorem 82.** *If  $f(x)$  has a unique and finite derivative at  $x = x_1$ , then  $f(x)$  is continuous at  $x_1$ .*

**Proof.** The proof depends upon the evident fact that if  $f(x) - f(x_1)$  approach anything but zero as  $x$  approaches  $x_1$ , then one of the values approached by

$$\frac{f(x) - f(x_1)}{x - x_1}$$

is  $+\infty$  or  $-\infty$ .

**Definition.**—The function  $f(x)$  is said to have a *maximum* at  $x = x_1$  if there exists a neighborhood  $V(x_1)$  such that

- (1) No value of  $f(x)$  in  $V(x_1)$  is greater than  $f(x_1)$ .
- (2) There is a value of  $x, x_2$ , in  $V(x_1)$  such that  $x_2 < x_1$  and  $f(x_2) < f(x_1)$ .
- (3) There is a value of  $x, x_3$ , in  $V(x_1)$  such that  $x_3 > x_1$  and  $f(x_3) < f(x_1)$ .

Similarly we define a *minimum* of a function.

This definition allows any point of a constant stretch like  $a$ , Fig. 17, to be a maximum, but does not allow any point of  $b$  to be either a maximum or a minimum.

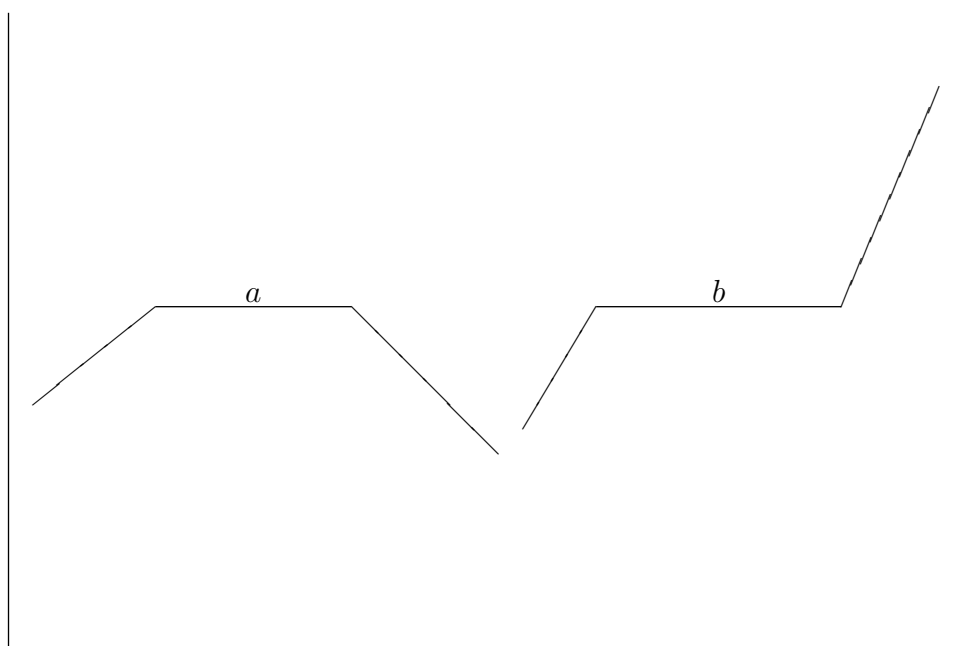

FIG. 17.

**Theorem 83.** *If  $f'(x_1)$  exists and if  $f(x)$  has a maximum or a minimum at  $x = x_1$ , then  $f'(x_1) = 0$ .*

**Proof.** In case of a maximum at  $x_1$ , it follows directly from the hypothesis that

$$\lim_{\substack{x \rightarrow x_1 \\ x > x_1}} \frac{f(x) - f(x_1)}{x - x_1} \leq 0, \text{ and also } \lim_{\substack{x \rightarrow x_1 \\ x < x_1}} \frac{f(x) - f(x_1)}{x - x_1} \geq 0,$$

Since  $f'(x_1)$  exists these limits are equal, that is, the derivative is equal to zero. Similarly in case of a minimum.

**Theorem 84.** *If  $f(x_1) = f(x_2)$ ,  $f(x)$  being continuous on the interval  $\overline{x_1 x_2}$ , and if the derivative exists<sup>3</sup> at every point between  $x_1$  and  $x_2$ , then there is a value  $\xi$  between  $x_1$  and  $x_2$  such that  $f'(\xi) = 0$ . The derivative need not exist at  $x_1$  and  $x_2$ .*

**Proof.** (a) The function may be a constant between  $x_1$  and  $x_2$ , in which case  $f'(x) = 0$  for all values of  $x$  between  $x_1$  and  $x_2$  by Theorem 74.

(b) There may be values of the function between  $x_1$  and  $x_2$  which are greater than  $f(x_1)$  and  $f(x_2)$ . Since the function is continuous on the interval  $\overline{x_1 x_2}$ , it reaches a least upper bound on this interval at some point  $x_3$  (different from  $x_1$  and  $x_2$ ). By Theorem 83,

$$f'(x_3) = 0.$$

---

<sup>3</sup>Not necessarily finite.

- (c) In case there are values of the function on the interval  $\overline{x_1 x_2}$  less than  $f(x_1)$ , the derivative is zero at the minimum point in precisely the same manner as under case (b).

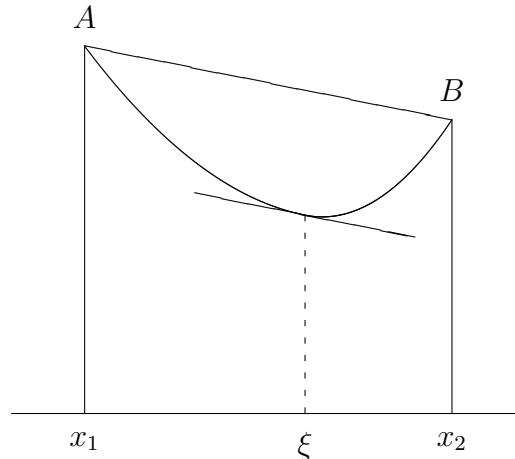

FIG. 18.

This theorem is called **ROLLE'S THEOREM**. The restriction that  $f(x)$  shall be continuous is unnecessary if the derivative exists, but simplifies the argument. The proof without this restriction is suggested as an exercise for the reader.

The geometric interpretation is that any curve representing a continuous function,  $f(x)$ , such that  $f(x_1) = f(x_2)$ , and having a tangent at every point between  $x_1$  and  $x_2$  has a horizontal tangent at some point between them. An immediate generalization of this is that between any two points  $A$  and  $B$  on a curve which satisfies the hypothesis of this theorem there is a tangent to the curve which is parallel to the line  $AB$ . The following theorem is a corresponding analytical generalization:

**Theorem 85.** *If  $f(x)$  is continuous on the interval  $\overline{x_1 x_2}$ , and if the derivative exists at every point between  $x_1$  and  $x_2$ , then there is a value of  $x$ ,  $x = \xi$ , between  $x_1$  and  $x_2$  such that*

$$f'(\xi) = \frac{f(x_1) - f(x_2)}{x_1 - x_2}.$$

**Proof.** Consider a function  $f_1(x)$  such that

$$f_1(x) = f(x) - (x - x_2) \cdot \frac{f(x_1) - f(x_2)}{x_1 - x_2};$$

then  $f_1(x_1) = f(x_1)$  and  $f_1(x_2) = f(x_2)$ . Therefore  $f_1(x_1) = f_1(x_2)$ . Hence, by Theorem 84, there is an  $x$ ,  $x = \xi$  on the segment  $\overline{x_1 x_2}$  such that  $f'_1(\xi) = 0$ . That is,

$$f'_1(\xi) = f'(\xi) - \frac{f(x_1) - f(x_2)}{x_1 - x_2} = 0.$$

Therefore

$$f'(\xi) = \frac{f(x_1) - f(x_2)}{x_1 - x_2}.$$

This is the “mean-value theorem.” Its content may also be expressed by the equation

$$f(x_2) = f(x_1) + (x_2 - x_1)f'(\xi).$$

Denoting  $x_1 - x$  by  $dx$  and  $\xi$  by  $x + \theta dx$ , where  $0 < \theta < 1$ , it takes the form

$$f(x_1 + dx) = f(x_1) + f'(x_1 + \theta dx)dx.$$

**Theorem 86.** If  $f_1(x)$  and  $f_2(x)$  are continuous on an interval  $a$   $\overline{b}$ , and if  $f_1'(x)$  and  $f_2'(x)$  exist between  $a$  and  $b$ ,  $f_2'(x) \neq \pm\infty$ , and  $f_2'(x) \neq 0$ ,  $f_2(a) \neq f_2(b)$ , then there is a value of  $x$ ,  $x = \xi$  between  $a$  and  $b$  such that

$$\frac{f_1(a) - f_1(b)}{f_2(a) - f_2(b)} = \frac{f_1'(\xi)}{f_2'(\xi)}.$$

**Proof.** Consider a function

$$f_3(x) = \frac{f_1(a) - f_1(b)}{f_2(a) - f_2(b)} \{f_2(x) - f_2(b)\} - \{f_1(x) - f_1(b)\}.$$

Since  $f_3(a) = 0$  and  $f_3(b) = 0$ , we have as before  $f_3'(\xi) = 0$ .

But

$$f_3'(\xi) = \frac{f_1(a) - f_1(b)}{f_2(a) - f_2(b)} \cdot f_2'(\xi) - f_1'(\xi).$$

Therefore

$$\frac{f_1(a) - f_1(b)}{f_2(a) - f_2(b)} = \frac{f_1'(\xi)}{f_2'(\xi)}.$$

This is called the second mean-value theorem. The first mean-value theorem has a very important extension to “Taylor’s series with a remainder,” which follows as Theorem 87.

## § 5 Taylor’s Series.

The derivative of  $f'(x)$  is denoted by  $f''(x)$  and is called the second derivative of  $f(x)$ . In general the  $n$ th derivative is the derivative of the  $n - 1$ st derivative and is denoted by  $f^{(n)}(x)$ .

**Theorem 87.** *If the first  $n$  derivatives of the function  $f(x)$  exist and are finite upon the interval  $\overline{a b}$ , there is a value of  $x$ ,  $x_n$  on the interval  $\overline{a b}$  such that*

$$f(b) = f(a) + \frac{(b-a)}{1!} f'(a) + \frac{(b-a)^2}{2!} f''(a) + \dots \\ + \frac{(b-a)^{n-1}}{(n-1)!} \cdot f^{(n-1)}(a) + \frac{(b-a)^n}{n!} f^{(n)}(x_n).$$

**Proof.** Let  $R_n$  be a constant such that

$$F(x) = f(x) - f(a) - (x-a)f'(a) - \frac{(x-a)^2}{2!} f''(a) - \dots \\ - \frac{(x-a)^{n-1}}{(n-1)!} f^{(n-1)}(a) - \frac{(x-a)^n}{n!} R_n$$

is equal to zero for  $x = b$ . Since  $F(x) = 0$  for  $x = a$ , there is, by Theorem 84, some value of  $x$ ,  $x_1$ ,  $a < x_1 < b$  such that  $F'(x_1) = 0$ . That is,

$$F'(x) = f'(x) - f'(a) - (x-a)f''(a) - \dots \\ - \frac{(x-a)^{n-2}}{(n-2)!} f^{(n-1)}(a) - \frac{(x-a)^{n-1}}{(n-1)!} R_n$$

is equal to zero for  $x = x_1$ . Since also  $F'(a) = 0$ , there is a value of  $x$ ,  $x_2$ ,  $a < x_2 < x_1$  such that  $F''(x_2) = 0$ . Proceeding in this manner we obtain a value of  $x$ ,  $x_n$ ,  $a < x_n < x_{n-1}$  such that

$$F^{(n)}(x_n) = 0.$$

But

$$F^{(n)}(x_n) = f^{(n)}(x_n) - R_n = 0.$$

Therefore

$$R_n = f^{(n)}(x_n),$$

whence the theorem.

*Corollary.*—In Theorem 87,  $f^{(n)}(x)$  need be supposed to exist only on  $\overline{a b}$ .

**Definition.**—The expression

$$\frac{(b-a)^n}{n!} R_n = \frac{(b-a)^n}{n!} f^{(n)}(x_n) = f(b) - \sum_{k=0}^{n-1} \frac{(b-a)^k}{k!} f^{(k)}(a)$$

is called the *remainder*, and the infinite series

$$\sum_{k=0}^{\infty} \frac{(b-a)^k}{k!} f^{(k)}(a)$$

is called *Taylor's Series*.

If

$$L_{n=\infty} \frac{f^{(n)}(x_n)(b-a)^n}{n!} = c,$$

a constant different from zero,  
then

$$\sum_{n=0}^{\infty} \frac{f^{(n)}(a)(b-a)^n}{n!}$$

is convergent but not equal to  $f(b)$ , i.e.,

$$\sum_{n=0}^{\infty} \frac{f^{(n)}(a)}{n!} \cdot (b-a)^n = f(b) - c.$$

If

$$L_{n=\infty} \frac{f^{(n)}(x_n)}{n!} \cdot (b-a)^n$$

fails to exist and be finite, then

$$\sum_{n=0}^{\infty} \frac{f^{(n)}(a)}{n!} \cdot (b-a)^n$$

is a divergent series.

Hence an obvious necessary and sufficient condition that for a function  $f(x)$  all of whose derivatives exist for the values of  $x$ ,  $a \bar{<} x \bar{<} b$ ,

$$f(b) = \sum_{n=0}^{\infty} \frac{f^{(n)}(a)}{n!} \cdot (b-a)^n,$$

is that

$$L_{n=\infty} \frac{f^{(n)}(x_n)}{n!} (b-a)^n = 0.^4$$

This leads at once, by Theorem 33, to the following sufficient condition:

**Theorem 88.** *If  $f^{(n)}(x)$  exists and  $|f^{(n)}(x)|$  is less than a fixed quantity  $M$  for every  $x$  on the interval  $\overline{a b}$  and for every  $n$  ( $n = 1, 2, \dots$ ), then*

$$f(b) = f(a) + \frac{(b-a)}{1!} f'(a) + \dots + \frac{(b-a)^n}{n!} f^{(n)}(a) + \dots$$

---

4

$$L_{n=\infty} \frac{f^{(n)}(x_n)}{n!} (b-a)^n = 0.$$

for every value of  $x$  on  $\overline{a b}$  is not sufficient, since  $x_n$  depends upon  $n$ .

Functions are well known all of whose derivatives exist at every point on an interval  $|a, b|$ , but such that for some point on this interval

$$\sum_{n=0}^{\infty} \frac{f^{(n)}(a)}{n!} (x-a)^n = f(x) + R(x),$$

where  $R$  is a function of  $x$  not identically zero. Other functions are known for which the series is divergent. The classical example of the former is that given by Cauchy,<sup>5</sup>  $e^{-\frac{1}{x^2}}$  at the point  $x = 0$ . If this function is defined to be zero for  $x = 0$ , all its derivatives are zero for  $x = 0$ , whence Taylor's development gives a function which is zero for all values of  $x$ .

PRINGSHEIM<sup>6</sup> has given a set of necessary and sufficient conditions that a function shall be representable for the values of  $h$ ,  $0 < h < R$ , by means of the series

$$\sum_{n=0}^{\infty} \frac{1}{n!} \cdot f^{(n)}(0) \cdot h^n.$$

It was remarked above, p. 105, that a necessary condition for  $f(x)$  to be a maximum at  $x = a$  is  $f'(a) = 0$  if the derivative exists. Taylor's series permits us to extend this as follows:

**Theorem 89.** *If on some  $V(a)$  the first  $n$  derivatives of  $f(x)$  exist and are finite and on  $V^*(a)$   $f^{(n+1)}(x)$  exists and is bounded,<sup>7</sup> and if*

$$\begin{aligned} 0 = f'(a) = f''(a) = \dots = f^{(n-1)}(a), \\ f^{(n)}(a) \neq 0, \end{aligned}$$

then:

- (1) *If  $n$  is odd,  $f(x)$  has neither a maximum nor a minimum at  $a$ ;*
- (2) *If  $n$  is even,  $f(x)$  has a maximum or a minimum according as  $f^{(n)}(a) < 0$  or  $f^{(n)}(a) > 0$ .*

**Proof.** By Taylor's theorem, for every  $x$  in the vicinity of  $a$

$$f(x) = f(a) + (x-a)^n f^{(n)}(a) + (x-a)^{n+1} \cdot f^{(n+1)}(\xi_x),$$

where  $\xi_x$  is between  $x$  and  $a$ . Hence

$$f(x) - f(a) = (x-a)^n \{f^{(n)}(a) + (x-a)f^{(n+1)}(\xi_x)\}.$$

<sup>5</sup>CAUCHY, *Collected Works*, 2d series, Vol. 4, p. 250.

<sup>6</sup>A. PRINGSHEIM, *Mathematische Annalen*, Vol. 44 (1893), p. 52, 53. See also KÖNIG, *Mathematische Annalen*, Vol. 23, p. 450.

<sup>7</sup>Instead of assuming the existence of  $f^{(n+1)}(x)$  we might have assumed  $f^{(n)}(x)$  continuous without essentially changing the proof.



But since  $f^{(n+1)}(\xi_x)$  is bounded and  $x - a$  is infinitesimal, there exists a  $\overline{V^*}(a)$  such that if  $x$  is in  $\overline{V^*}(a)$ ,

$$f(x) - f(a)$$

is positive or negative according as

$$(x - a)^n \cdot f^{(n)}(a)$$

is positive or negative.

- (1) If  $n$  is odd,  $(x - a)^n$  is of the same sign as  $x - a$ , and hence for  $f^{(n)}(a) > 0$

$$\begin{aligned} f(x) - f(a) &> 0 && \text{if } x > a, \\ f(x) - f(a) &< 0 && \text{if } x < a; \end{aligned}$$

while for  $f^{(n)}(a) < 0$

$$\begin{aligned} f(x) - f(a) &> 0 && \text{if } x < a, \\ f(x) - f(a) &< 0 && \text{if } x > a. \end{aligned}$$

- (2) If  $n$  is even,  $(x - a)^n$  is always positive, and hence if  $f^{(n)}(a) > 0$ ,

$$\left. \begin{aligned} f(x) - f(a) &> 0 && \text{if } x > a, \\ f(x) - f(a) &> 0 && \text{if } x < a; \end{aligned} \right\} \text{ then } f(a) \text{ is a maximum.}$$

If  $f^{(n)}(a) < 0$ ,

$$\left. \begin{aligned} f(x) - f(a) &< 0 && \text{if } x > a, \\ f(x) - f(a) &< 0 && \text{if } x < a; \end{aligned} \right\} \text{ then } f(a) \text{ is a minimum.}$$

## § 6 Indeterminate Forms.

The mean-value theorems have an important application in the derivation of L'HOSPITAL'S rule for calculating "indeterminate forms." There are seven cases.

- (1)  $\frac{0}{0}$ , i.e., to compute  $L \frac{f(x)}{\phi(x)}$  if  $L f(x) = 0$  and  $L \phi(x) = 0$ .

- (2)  $\frac{\infty}{\infty}$ , i.e., to compute  $L \frac{f(x)}{\phi(x)}$  if  $L f(x) = \pm\infty$  and  $L \phi(x) = \pm\infty$ .

- (3)  $\infty - \infty$ , i.e., to compute  $L \{f(x) - \phi(x)\}$  if  $L f(x) = \pm\infty$  and  $L \phi(x) = \pm\infty$ .

(4)  $0 \cdot \infty$ , i.e., to compute  $\underset{x \dot{=} a}{L} f(x) \cdot \phi(x)$  if  $\underset{x \dot{=} a}{L} f(x) = 0$  and  $\underset{x \dot{=} a}{L} \phi(x) = \pm\infty$ .

(5)  $1^\infty$ , i.e., to compute  $\underset{x \dot{=} a}{L} f(x)^{\phi(x)}$  if  $\underset{x \dot{=} a}{L} f(x) = 1$  and  $\underset{x \dot{=} a}{L} \phi(x) = \pm\infty$ .

(6)  $0^0$ , i.e., to compute  $\underset{x \dot{=} a}{L} f(x)^{\phi(x)}$  if  $\underset{x \dot{=} a}{L} f(x) = 0$  and  $\underset{x \dot{=} a}{L} \phi(x) = 0$ .

(7)  $\infty^0$ , i.e., to compute  $\underset{x \dot{=} a}{L} f(x)^{\phi(x)}$  if  $\underset{x \dot{=} a}{L} f(x) = \pm\infty$  and  $\underset{x \dot{=} a}{L} \phi(x) = 0$ .

These problems may all be reduced to one or the other of the first two. The third may be written (since  $f(x) \neq 0$  on some  $V^*(a)$ )

$$f(x) - \phi(x) = \frac{1}{\frac{1}{f(x)}} - \phi(x) = \frac{1 - \frac{\phi(x)}{f(x)}}{\frac{1}{f(x)}},$$

which is either determinate or of type (1).

To the cases (5), (6), and (7) we may apply the corollaries of Theorem 39 of Chapter IV, from which it follows (provided  $f(x) \neq 0$  on some  $V^*(a)$ ), that

$$\underset{x \dot{=} a}{L} f(x)^{\phi(x)}$$

exists if and only if

$$\log \underset{x \dot{=} a}{L} f(x)^{\phi(x)} = \underset{x \dot{=} a}{L} \log f(x)^{\phi(x)} = \underset{x \dot{=} a}{L} \phi(x) \log f(x) \text{ exists.}$$

The evaluation of

$$\underset{x \dot{=} a}{L} \frac{\log f(x)}{\frac{1}{\phi(x)}}$$

comes under case (1) or case (2).

The evaluation of cases (1) and (2) is effected by the following theorems:

**Theorem 90.** *If  $f(x)$  and  $\phi(x)$  are continuous and differentiable and  $\phi(x)$  is monotonic and  $\phi'(x) \neq 0$  and  $\phi'(x) \neq \infty$  and*

(1) *if  $\underset{x \dot{=} \infty}{L} f(x) = 0$  and  $\underset{x \dot{=} \infty}{L} \phi(x) = 0$  or*

(2) *if  $\underset{x \dot{=} \infty}{L} \phi(x) = \pm\infty$ ,*<sup>8</sup>

*then if*

$$\underset{x \dot{=} \infty}{L} \frac{f'(x)}{\phi'(x)} = K,$$

$$\underset{x \dot{=} \infty}{L} \frac{f(x)}{\phi(x)}$$

*exists and is equal to  $K$ .*

---

<sup>8</sup>It is not necessary that  $Lf(x) = \infty$ ; cf. Theorem 69.

**Proof.** For every positive  $h$  we have, by the second mean-value theorem,

$$\frac{f(x+h) - f(x)}{\phi(x+h) - \phi(x)} = \frac{f'(\xi_x)}{\phi'(\xi_x)},$$

where  $\xi_x$  lies between  $x$  and  $x+h$ . But since  $\xi_x$  takes on values which are a subset of the values of  $x$ , and since  $\lim_{x \rightarrow \infty} \xi_x = \infty$ ,

$$\lim_{x \rightarrow \infty} \frac{f'(x)}{\phi'(x)} = K \quad \text{implies} \quad \lim_{x \rightarrow \infty} \frac{f'(\xi_x)}{\phi'(\xi_x)} = K,$$

which in turn implies

$$\lim_{x \rightarrow \infty} \frac{f(x+h) - f(x)}{\phi(x+h) - \phi(x)} = K,$$

and this, according to Theorems 68 and 69, gives

$$\lim_{x \rightarrow \infty} \frac{f(x)}{\phi(x)} = K.$$

*Corollary.*—If  $f(x)$  is continuous and differentiable, then

$$\lim_{x \rightarrow \infty} \frac{f(x)}{x} = \lim_{x \rightarrow \infty} f'(x).$$

The theorem above can be extended by the substitution

$$z = \frac{1}{x-a}$$

to the case where  $x$  approaches a finite value  $a$ . The approach must of course be one-sided.

**Theorem 91.** *If  $f(x)$  and  $\phi(x)$  are continuous and differentiable on some  $V^*(a)$  and  $f(x)$  is bounded on every finite interval, while  $\phi(x)$  is monotonic and*

(1)  $\lim_{x \rightarrow a} f(x) = 0$ ,  $\lim_{x \rightarrow a} \phi(x) = 0$  or

(2)  $\lim_{x \rightarrow a} \phi(x) = +\infty$  or  $-\infty$ :

then if

$$\lim_{x \rightarrow a} \frac{f'(x)}{\phi'(x)} = K,$$

it follows that

$$\lim_{x \rightarrow a} \frac{f(x)}{\phi(x)}$$

exists and is equal to  $K$ .

**Proof.** If  $\lim_{x \rightarrow a} \frac{f'(x)}{\phi'(x)}$  exists, the limit exists when the approach is only on values of  $x > a$ . Consider only such values of  $x$ . Then if

$$z = \frac{1}{x - a}, \quad f(x) = f\left(a + \frac{1}{z}\right) = F(z)$$

and

$$\phi(x) = \phi\left(a + \frac{1}{z}\right) = \Phi(z),$$

by hypothesis and Theorem 79,  $F'(z)$  and  $\Phi'(z)$  exist and

$$F'(z) = f'(x) \frac{dx}{dz},$$

$$\Phi'(z) = \phi'(x) \frac{dx}{dz}.$$

Hence if

$$\lim_{x \rightarrow a} \frac{f'(x)}{\phi'(x)} = K,$$

then, according to Theorem 38,

$$\lim_{x \rightarrow \infty} \frac{F'(z)}{\Phi'(z)}$$

exists and is equal to  $K$ . Hence, by Theorem 90,

$$\lim_{x \rightarrow \infty} \frac{F(z)}{\Phi(z)}$$

exists and is equal to  $K$ . Hence, by Theorem 38,

$$\lim_{x \rightarrow a} \frac{f(x)}{\phi(x)}$$

exists and is equal to  $K$ .

We have now derived conditions under which we can state a general rule for computing an indeterminate form.

Provided  $f(x)$  is not zero on every  $V^*(a)$ , any of the forms (3) to (7) can be reduced to

$$\frac{F(x)}{\Phi(x)} \tag{a}$$

where this is of type (1) or (2). Provided  $F(x)$  and  $\Phi(x)$  satisfy the conditions of Theorem 91, the existence of the limit of (a) depends on the existence of the limit of

$$\frac{F'(x)}{\Phi'(x)}. \tag{b}$$

If (b) is indeterminate, and  $F'(x)$  and  $\Phi'(x)$  satisfy the conditions of Theorem 91, the limit of (b) depends on the limit of

$$\frac{F''(x)}{\Phi''(x)}, \tag{c}$$

and so on in general. If at each step the conditions of Theorem 91 are satisfied and the form is still indeterminate, the limit of

$$\frac{F^{(n)}(x)}{\Phi^{(n)}(x)} \tag{n}$$

depends on the limit of

$$\frac{F^{(n+1)}(x)}{\Phi^{(n+1)}(x)}. \tag{n + 1}$$

If (n) is indeterminate for all values of  $n$ , this rule leads to no result. If for some value of  $n$

$$\lim_{x \rightarrow a} \frac{F^{(n)}(x)}{\Phi^{(n)}(x)} = K,$$

then all the preceding limits exist and are equal to  $K$ , and so

$$\lim_{x \rightarrow a} \frac{F(x)}{\Phi(x)} = K.$$

The original expression is equal to  $K$  or  $e^K$  according to the case under consideration.

## § 7 General Theorems on Derivatives.

**Theorem 92.** If  $f(x)$  is continuous and  $f'(x)$  exists for every  $x$  on an interval  $a b$ , then  $f'(x)$  takes on every value between any two of its values.

**Proof.** Consider any two values of  $f'(x)$ ,  $f'(x_1)$ , and  $f'(x_2)$  on the interval  $a b$ . Consider, further, the function  $\frac{f(x)-f(x_1)}{x-x_1}$  on the interval between  $x_1$  and  $x_2$ . Since  $\frac{f(x)-f(x_1)}{x-x_1}$  is a continuous function of  $x$  on this interval, it takes on every value between  $\frac{f(x_2)-f(x_1)}{x_2-x_1}$  and  $f'(x_1)$ , which is its limiting value as  $x$  approaches  $x_1$ . Hence, by Theorem 85,  $f'(x)$  takes on all values between and including  $f'(x_1)$ , and  $\frac{f(x_2)-f(x_1)}{x_2-x_1}$  for values of  $x$  on the interval  $x_1 x_2$ . By considering in a similar manner the function  $\frac{f(x_2)-f(x)}{x_2-x}$  on the interval  $x_1 x_2$ , we show that  $f'(x)$  takes on all values between  $\frac{f(x_2)-f(x_1)}{x_2-x_1}$  and  $f'(x_2)$ . Hence  $f'(x)$  takes on all values between  $f'(x_1)$  and  $f'(x_2)$ .

**Theorem 93.** If the derivative exists at every point on an interval, including its end-points, it does not follow that the derivative is continuous or that it takes on its upper and lower bounds.

**Proof.** This is shown by the following example.

The curve shall lie between the  $x$ -axis and the parabola  $y = \frac{1}{2}x^2$ . The straight lines of slopes  $1, 1\frac{1}{2}, 1\frac{3}{4}, \dots, 1 + \frac{2^n-1}{2^n} \dots$  through the points  $(\frac{1}{2}, 0), (\frac{1}{4}, 0), \dots, (\frac{1}{2^{n+1}}, 0), \dots$ , respectively, meet the parabola in points  $A_1, A_2, A_3, \dots, A_n, \dots$ . The broken line  $A_1 (\frac{1}{2}, 0) A_2 (\frac{1}{4}, 0) A_3 \dots A_n (\frac{1}{2^n}, 0) \dots \infty$ , has an infinitude of vertices. In each angle of the broken

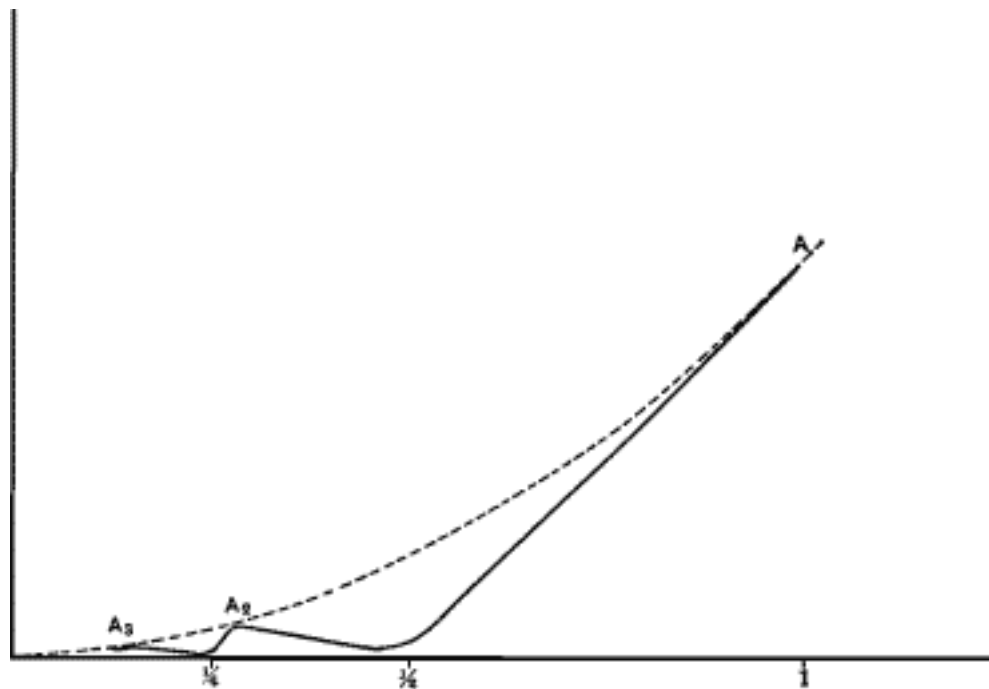

FIG. 19.

line consider an arc of circle tangent to and terminated by the sides of the angle, the points of tangency being one fourth of the distance to the nearest vertex. The function whose graph consists of these circular arcs and the portions of the broken line between them is continuous and differentiable on the interval  $0 \overset{|}{\underset{|}{1}}$ . Its derivative is discontinuous at  $x = 0$  and has the least upper bound 2, which is never reached.

**Theorem 94.** If  $f'(x)$  exists and is equal to zero for every value of  $x$  on the interval  $a \overset{|}{\underset{|}{b}}$ , then  $f(x)$  is a constant on that interval.

**Proof.** By Theorem 82,  $f(x)$  is continuous. Suppose  $f(x)$  not a constant, so that for two values of  $x$ ,  $x_1$ , and  $x_2$ ,  $f(x_1) \neq f(x_2)$ , then, by Theorem 85, there is a value of  $x$ ,  $x = \xi$  between  $x_1$  and  $x_2$  such that

$$f'(\xi) = \frac{f(x_2) - f(x_1)}{x_2 - x_1},$$

which is different from zero, whence  $f'(x)$  is not zero for every value of  $x$  on the interval  $a \overset{|}{\underset{|}{b}}$ . Hence  $f(x)$  is a constant on  $a \overset{|}{\underset{|}{b}}$ .

*Corollary.*—If  $f_1'(x) = f_2'(x)$  and is finite for every value of  $x$  on an interval  $\overline{a b}$ , then  $f_1(x) - f_2(x)$  is a constant on this interval.

**Theorem 95.** *If  $f'(x)$  exists and is positive for every value of  $x$  on the interval  $\overline{a b}$ , then  $f(x)$  is monotonic increasing on this interval. If  $f'(x)$  is negative for every value of  $x$  on this interval, then  $f(x)$  is monotonic decreasing.*

**Proof.** If  $f'(x)$  is positive for every value of  $x$ , then it follows from Theorem 85, provided that  $f(x)$  is continuous, that the function is monotonic increasing, for if there were two values of  $x$ ,  $x_1$  and  $x_2$ , such that  $f(x_1) \geq f(x_2)$  while  $x_1 < x_2$ , then there would be a value of  $x$ ,  $x = \xi$ , between  $x_1$  and  $x_2$  such that

$$f'(\xi) = \frac{f(x_2) - f(x_1)}{x_2 - x_1} \leq 0.$$

In case  $f(x)$  is not supposed continuous, the argument can be made as follows: If  $f'(x_1) > 0$ , then, by Theorem 23, there exists about the point  $x_1$  a segment  $\overline{(x_1 - \delta) (x_1 + \delta)}$ , upon which

$$\frac{f(x) - f(x_1)}{x - x_1} > 0,$$

and hence, if  $x > x_1$ ,  $f(x) > f(x_1)$  and if  $x < x_1$ ,  $f(x) < f(x_1)$ . Now about every point of the segment  $\overline{a b}$  there is such a segment. Let  $x'$  and  $x''$  be any two points of  $\overline{a b}$  such that  $x' < x''$ . By Theorem 10, there is a finite set of these segments of lengths  $\delta_1 \dots \delta_n$  which include within them every point of the interval  $\overline{x' x''}$ . We thus have a finite set of points, namely, the mid-point and points on the overlapping parts of the segments,  $x' < x_1 < x_2 < \dots < x_k < x''$ , such that

$$f(x') < f(x_1) < f(x_2) < \dots < f(x_k) < f(x'').$$

Hence  $f(x') < f(x'')$ . In a similar manner we prove that the function is monotonic decreasing in case  $f'(x)$  is negative.

**Theorem 96.** *If a function  $f(x)$  is monotonic increasing on an interval  $\overline{a b}$ , and if  $f'(x)$  exists for every value of  $x$  on this interval, then there is no point on the interval for which  $f'(x)$  is negative. That is,  $f'(x)$  is either positive or zero for every point of  $\overline{a b}$ .*

**Proof.** If  $f'(x)$  is negative for some value of  $x$ , say  $x_1$ , then

$$\lim_{x \rightarrow x_1} \frac{f(x) - f(x_1)}{x - x_1} = C, \text{ a negative number,}$$

whence there is a neighborhood of  $x_1$  on which  $f(x) > f(x_1)$ , while  $x < x_1$ , or  $f(x_1) > f(x)$ , while  $x > x_1$ , which is contrary to the hypothesis that the function is monotonic increasing in the neighborhood of  $x = x_1$ . In the same manner we prove that if the function is monotonic decreasing, and if the derivative exists, then  $f'(x)$  cannot be positive.

The following theorem states necessary and sufficient conditions for the existence of the progressive and regressive derivatives. Conditions for the existence of a derivative proper are obtained by adding the condition that the progressive and regressive derivatives are equal.

**Theorem 97.** *If  $f(x)$ ,  $x < x_1$ , is continuous in some neighborhood of  $x = x_1$ , then a necessary and sufficient condition that  $f'(x_1)$  shall exist and be finite is that there exists not more than one linear function of  $x$ ,  $ax + c$ , such that  $f(x) + ax + c$  vanishes on every neighborhood of  $x = x_1$ .*

**Proof.** (1) *The condition is necessary.* We prove that if  $f'(x)$  exists and is finite, then not more than one function of the form  $ax + c$  exists such that  $f(x) + ax + c$  vanishes on every neighborhood of  $x = x_1$ . If no such function exists, the theorem is verified. If there is one such function, the following argument will show that there is only one. Since, by hypothesis,

$$L_{x \dot{=} x_1} \frac{f(x) - f(x_1)}{x - x_1}$$

exists, we have, by Theorem 75, that

$$L_{x \dot{=} x_1} \frac{f(x) + ax + c - f(x_1) - ax_1 - c}{x - x_1}$$

exists. Let  $[x']$  be the subset of the set of values of  $x$  on any neighborhood of  $x = x_1$  such that  $f(x') + ax' + c$  vanishes on the set  $[x']$ . By Theorem 41,

$$\begin{aligned} L_{x' \dot{=} x_1} \frac{f(x') + ax' + c - f(x_1) - ax_1 - c}{x' - x_1} \\ = L_{x \dot{=} x_1} \frac{f(x) + ax + c - f(x_1) - ax_1 - c}{x - x_1} = f'(x_1) + a. \end{aligned}$$

Since  $f'(x_1)$  and  $a$  are both finite,

$$L_{x' \dot{=} x_1} \frac{f(x') + ax' + c' - f(x_1) - ax_1 - c}{x' - x_1}$$

is finite. But the numerator of this fraction is a constant,  $f(x) + ax + c$  being zero on the set  $[x']$ . Hence

$$L_{x \dot{=} x_1} \frac{f(x) + ax + c - f(x_1) - ax_1 - c}{x - x_1} = 0, \quad \text{or} \quad f'(x_1) + a = 0,$$

and, being continuous,  $f(x_1) + ax_1 + c = 0$ . The numbers  $a$  and  $c$  are uniquely determined by the equations

$$\begin{cases} f'(x_1) + a = 0, \\ f(x_1) + ax_1 + c = 0. \end{cases}$$



(2) *The condition is sufficient.* We are to show that

$$\lim_{x \rightarrow x_1} \frac{f(x) - f(x_1)}{x - x_1}$$

can fail to exist only when there are at least two functions of the form  $ax + c$  such that  $f(x) + ax + c$  vanishes on every neighborhood of  $x = x_1$ . If

$$\lim_{x \rightarrow x_1} \frac{f(x) - f(x_1)}{x - x_1}$$

does not exist, then

$$\frac{f(x) - f(x_1)}{x - x_1}$$

approaches at least two distinct values  $K_1$  and  $K_2$ . Let  $K_2 < K_1$ . Let  $A$  and  $B$  be two finite values such that  $K_2 < A < B < K_1$ . On every neighborhood of  $x = x_1$  there are values of  $x$  for which

$$\frac{f(x) - f(x_1)}{x - x_1}$$

is greater than  $B$ , and also values of  $x$  for which

$$\frac{f(x) - f(x_1)}{x - x_1}$$

is less than  $A$ . Hence, since

$$\frac{f(x) - f(x_1)}{x - x_1}$$

is continuous at every point except possibly  $x_1$ , in a certain neighborhood of  $x_1$  there are values of  $x$  in every neighborhood of  $x_1$  for which

$$\frac{f(x) - f(x_1)}{x - x_1} = A,$$

or

$$f(x) - f(x_1) = A(x - x_1),$$

which gives

$$-f(x_1) - A(x - x_1)$$

as one function of the form  $ax + c$ .

In the same manner we show that  $-f(x_1) - B(x - x_1)$  is another function  $ax + c$ , which makes  $f(x) + ax + c$  vanish on every neighborhood of  $x = x_1$ .

The geometric meaning of this theorem is obvious. If  $P$  is a point on the curve representing  $f(x)$ , then a necessary and sufficient condition that this curve shall have a tangent at  $P$  is that there exists not more than one line through  $P$  which intersects the curve an infinite number of times on any neighborhood of  $P$ . Compare the functions  $x \sin \frac{1}{x}$  and  $x^2 \sin \frac{1}{x}$  on page 38.

The earlier mathematicians supposed that every continuous function must have a derivative except at particular points. The first example of a function which has no derivative at any point is due to WEIERSTRASS.<sup>9</sup> The function is

$$f(x) = \sum_{n=0}^{\infty} b^n \cos(a^n \pi x),$$

where  $a$  is an odd integer,  $0 < b < 1$  and  $ab > 1 + \frac{3}{2}\pi$ .

---

<sup>9</sup>For references and remarks see page 38.

# Chapter 8

## DEFINITE INTEGRALS.

### § 1 Definition of the Definite Integral.

The area of a rectangle the lengths of whose sides are exact multiples of the length of the side of a unit square, is the number of squares equal to the unit square contained within the rectangle, and is easily seen to be equal to the product of the lengths of its base and altitude.<sup>1</sup>

In case the sides of the rectangle and the side of the unit square are commensurable, the sides of the rectangle not being exact multiples of the side of the square, the rectangle and the square are divided into a set of equal squares. The area of the rectangle is then defined as the ratio of the number of squares in the rectangle to be measured to the number of squares in the unit square. Again, the area is equal to the product of the base and altitude.

Any figure so related to the unit square that both figures can be divided into a finite set of equal squares is said to be commensurable with the unit.

The area of a rectangle incommensurable with the unit is defined as the least upper bound of the areas of all commensurable rectangles contained within it.

It follows directly from the definition of the product of irrational numbers that this process gives the area as the product of the base and altitude.<sup>2</sup>

Turning to the figure bounded by the segment  $\overline{ab}$  (which we take on the  $x$  axis in a system of rectangular coordinates) the graph of a function  $y = f(x)$  and the ordinates  $x = a$  and  $x = b$ , we obtain as follows an approximation to the common notion of the area of such figures.

Let  $x_0 = a, x_1, x_2, \dots, x_n = b$  be a set of points lying in order from  $a$  to  $b$ . Such a set of points is called a partition of  $\overline{ab}$ , and is denoted by  $\pi$ . The intervals  $\overline{x_0 x_1}, \overline{x_1 x_2}, \dots, \overline{x_{n-1} x_n}$  are intervals of  $\pi$ .

---

<sup>1</sup>Of course the units are not necessarily squares; they may be triangles, parallelograms, etc.

<sup>2</sup>For the meaning of the length of a segment incommensurable with the unit segment, compare Chapter II, page 25.

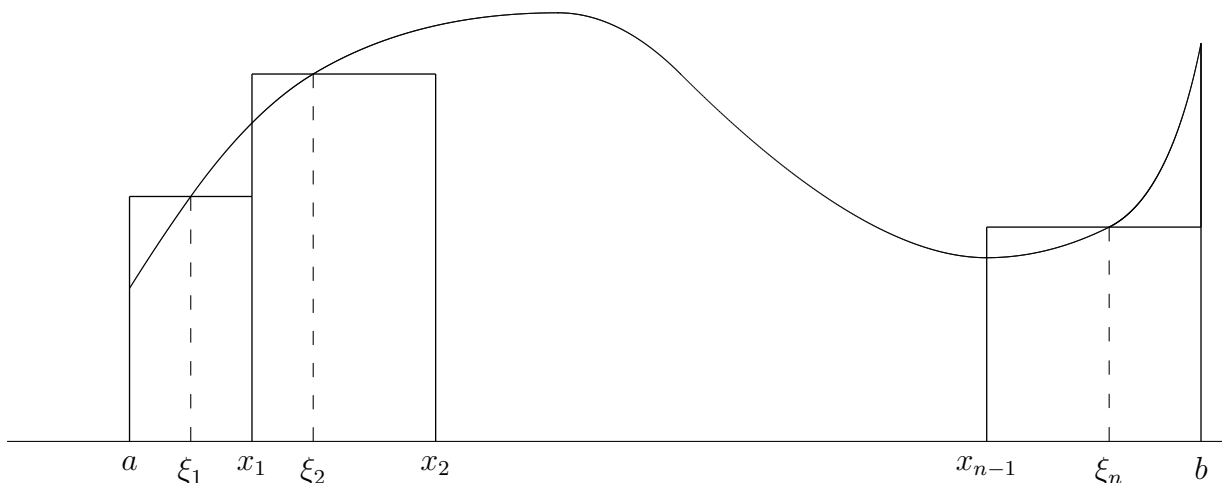

FIG. 20

Let  $x_1 - x_0 = \Delta_1x, x_2 - x_1 = \Delta_2x, \dots, x_n - x_{n-1} = \Delta_nx$ , and let

$$\xi_1, \xi_2, \dots, \xi_n$$

be a set of points such that  $\xi_1$  is on the interval  $\overline{x_0 x_1}$ ,  $\xi_2$  is on  $\overline{x_1 x_2}$ , ..., and  $\xi_n$  is on  $\overline{x_{n-1} x_n}$ . Then

$$f(\xi_1), f(\xi_2), \dots, f(\xi_n)$$

are the altitudes of a set of rectangles whose combined area is a more or less close approximation of the area of our figure. Denote this approximate area by  $S$ . Then

$$S = f(\xi_1)\Delta_1x + f(\xi_2)\Delta_2x + \dots + f(\xi_n)\Delta_nx = \sum_{k=1}^n f(\xi_k)\Delta_kx.$$

As the greatest  $\Delta_kx$  is taken smaller and smaller, the figure composed of the rectangles comes nearer to the figure bounded by the curve.

In consequence of these geometrical notions we define the area of the figure as the limit of  $S$  as the  $\Delta_kx$ 's decrease indefinitely. The area  $S$  is the definite integral of  $f(x)$  from  $a$  to  $b$ . It has been tacitly assumed that the graph of  $y = f(x)$  is continuous, since we do not usually speak of an area being enclosed by a discontinuous curve. The definition of the definite integral when stated in its general form admits, however, of functions which are discontinuous in a great variety of ways. A more general definition of the definite integral is as follows:

Let  $\overline{a b}$  (or  $\overline{b a}$ ) be an interval upon which a function  $f(x)$  is defined, single-valued and bounded. Let  $\pi_\delta$  stand for any partition of  $\overline{a b}$  or  $\overline{b a}$  by the points  $a = x_0, x_1, x_2, \dots, x_n = b$  such that the numbers  $\Delta_1x = x_1 - a, \Delta_2x = x_2 - x_1, \dots, \Delta_nx = b - x_{n-1}$  are each numerically less than or equal to  $\delta$ . Let

$$\xi_1, \xi_2, \dots, \xi_n$$

be a set of points on the intervals  $\overline{x_0 x_1}, \overline{x_1 x_2}, \dots, \overline{x_{n-1} x_n}$  (or if  $b < a$ ,  $\overline{x_1 x_0}, \overline{x_2 x_1}, \overline{x_3 x_2}, \dots, \overline{x_n x_{n-1}}$ ) respectively, and let

$$S_\delta = f(\xi_1)\Delta_1x + f(\xi_2)\Delta_2x + \dots + f(\xi_n)\Delta_nx = \sum_{k=1}^n f(\xi_k)\Delta_kx.$$

If the many-valued function of  $\delta$ ,  $S_\delta$ , approaches a single limiting value as  $\delta$  approaches zero, then

$$\lim_{\delta \rightarrow 0} S_\delta = \int_a^b f(x)dx.$$

When we desire to indicate the interval of integration we write  ${}_a^b S_\delta$  and  ${}_a^b \pi_\delta$  instead of  $S_\delta$  and  $\pi_\delta$ .  $a$  and  $b$  are called the *limits of integration*.

The details of this definition should be carefully noted. For every  $\delta$  there is an infinite number of different partitions  $\pi_\delta$ , and for every partition there is an infinite set of different sets of  $\xi_k$ , so that for every  $\delta$  the function  $S_\delta$  has an infinite set of values. The graph of the function  $S_\delta$  is of the type shown in Fig. 21. Every value of  $S_\delta$  for one  $\delta$  is assumed by  $S$  for every larger  $\delta$ . For any particular value of  $\delta$  the values of  $S_\delta$  lie on a definite interval  $\overline{BS_\delta BS_\delta}$ , whose length never increases as  $\delta$  decreases. If this interval approaches 0 as  $\delta$  approaches 0, the required limit exists.

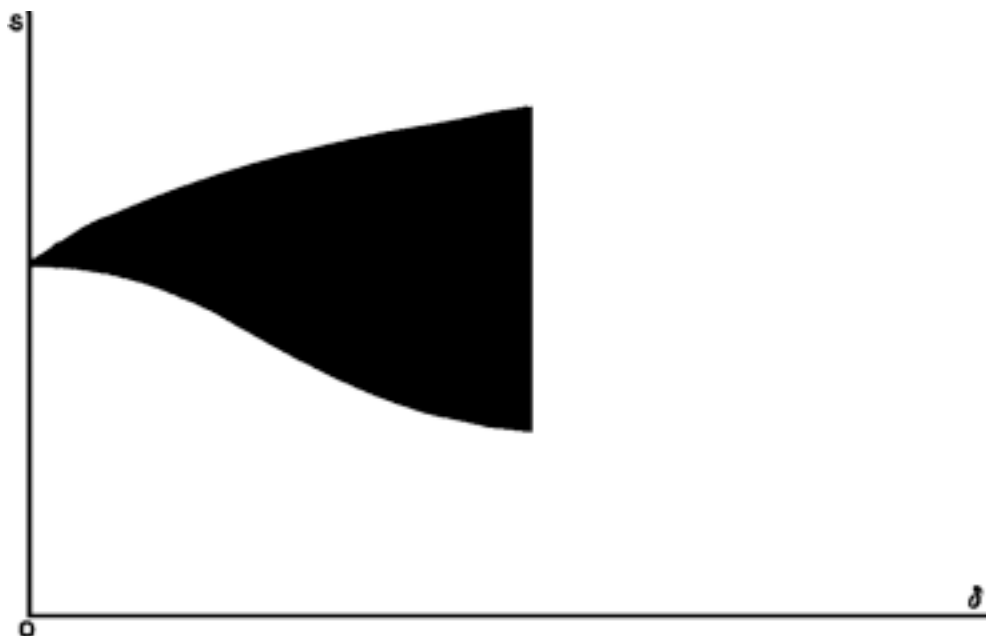

FIG. 21.

It is to be noticed that the set of  $\pi$ 's,  $[\pi_\delta]$  includes every possible  $\pi$  whose largest  $\Delta_kx$  is less than  $\delta$ . Thus we cannot obtain the set of all  $\pi$ 's by sequential repartitioning of any

given  $\pi$ , since there are partitions of the set  $[\pi_\delta]$  which have no partition points in common with any given partition. Inattention to this point is perhaps the greatest source of error in the development of the notion of a definite integral.

## § 2 Integrability of Functions.

The class of integrable functions is very large, including nearly all the bounded functions studied in mathematics and physics. Even such an arbitrary function as

$$\begin{cases} y = 0 & \text{if } x \text{ irrational,} \\ y = 1/n^3 & \text{if } x = m/n, \end{cases}$$

is integrable. (See page 147, Theorem 127.)

Examples of non-integrable functions are  $y = 1/x$  on the interval  $\overline{0 \ 1}$  (where it is not bounded, see page 153), and the function,

$$\begin{cases} y = 0 & \text{if } x \text{ is irrational and} \\ y = 1 & \text{if } x \text{ is rational.} \end{cases}$$

To determine the conditions of integrability we introduce the concept of integral oscillation. On any interval  $\overline{a \ b}$ ,  $f(x)$  has a least upper bound  $A$  and a greatest lower bound  $B$ , between which the function varies. If  $A - B = \Delta y = {}^b_a O f(x)$  is multiplied by the length of the interval,  $\Delta x = |b - a|$ , it gives the area of a rectangle, including the graph of  $f(x)$ . If the interval is subdivided by a partition  $\pi$ , the sum of the products  $\Delta x \cdot \Delta y$  on the intervals of the partition is called the *integral oscillation of  $f(x)$  for the partition  $\pi$*  and is denoted by  $O_\pi$ . If we call  $\Delta_k y$  the difference between the upper and lower bounds of  $f(x)$  on the intervals  $\overline{x_{k-1} \ x_k}$ , we have

$$O_\pi = |\Delta_1 x| \cdot \Delta_1 y + |\Delta_2 x| \cdot \Delta_2 y + \dots + |\Delta_n x| \Delta_n y = \sum_{k=1}^n |\Delta_k x| \cdot \Delta_k y.$$

Geometrically  $O_\pi$  represents the areas of the rectangles  $F_1, \dots, F_n$  (Fig. 22), and so we expect to find that if the lower bound of  $O_\pi$  is zero,  $f(x)$  is integrable. This proposition, which requires some rather delicate argument for its proof, will be taken up in § 7. At present we shall show in a simple manner that every continuous and every monotonic function is integrable.

**Lemma 1.**—If  $S_\pi$  and  $S'_\pi$  are two sums (formed by using different  $\xi_k$ 's) on the same partition, then

$$|S_\pi - S'_\pi| \leq O_\pi.$$

**Proof.**

$$S_\pi = \sum_{k=1}^n f(\xi_k) \Delta_k x,$$

$$S'_\pi = \sum_{k=1}^n f(\xi'_k) \Delta_k x,$$

$$|S_\pi - S'_\pi| = \left| \sum_{k=1}^n \{f(\xi_k) - f(\xi'_k)\} \Delta_k x \right| \leq \sum_{k=1}^n |f(\xi_k) - f(\xi'_k)| \cdot |\Delta_k x|.$$

But  $|f(\xi_k) - f(\xi'_k)| \leq \Delta_k y$  by the definition of  $\Delta_k y$ . Therefore

$$|S_\pi - S'_\pi| \leq \sum_{k=1}^n |\Delta_k x| \cdot \Delta_k y \tag{4}$$

A *repartition* of a partition  $\pi$  is formed by introducing new points in  $\pi$ .

**Lemma 2.**—If  $\pi_1$  is a repartition of  $\pi$ ,

$$|S_\pi - S_{\pi_1}| \leq O_\pi.$$

**Proof.** Any interval  $\Delta_k x$  of  $\pi$  is composed of one or more intervals  $\Delta'_k x$ ,  $\Delta''_k x$ , etc., of  $\pi_1$ , and these contribute to  $S_\pi$  the terms

$$f(\xi'_k) \Delta'_k x + f(\xi''_k) \Delta''_k x + \dots \tag{1}$$

The corresponding term of  $S_\pi$  is

$$f(\xi_k) \Delta_k x = f(\xi_k) \Delta'_k x + f(\xi_k) \Delta''_k x + \dots \tag{2}$$

But since  $|f(\xi_k) - f(\xi_{k'})| \leq \Delta_k y$ , the difference between (1) and (2) is less than or equal to

$$\Delta_k y \cdot |\Delta'_k x + \Delta''_k x + \dots| = \Delta_k y \cdot |\Delta_k x|$$

and hence

$$|S_\pi - S_{\pi_1}| \leq \sum_{k=1}^n \Delta_k y \cdot |\Delta_k x| = O_\pi.$$

**Theorem 98.** Every function continuous on  $\overline{a b}$  is integrable on  $\overline{a b}$ .

**Proof.** We have to investigate the existence of the limit  $\lim_{\delta \doteq 0} S_\delta$  of the many-valued function  $S_\delta$  as  $\delta \doteq 0$ . Since  $S_\delta$  approaches at least one value as  $\delta$  approaches zero (see Theorem 24), we need only to prove that it cannot have more than one value approached. Suppose

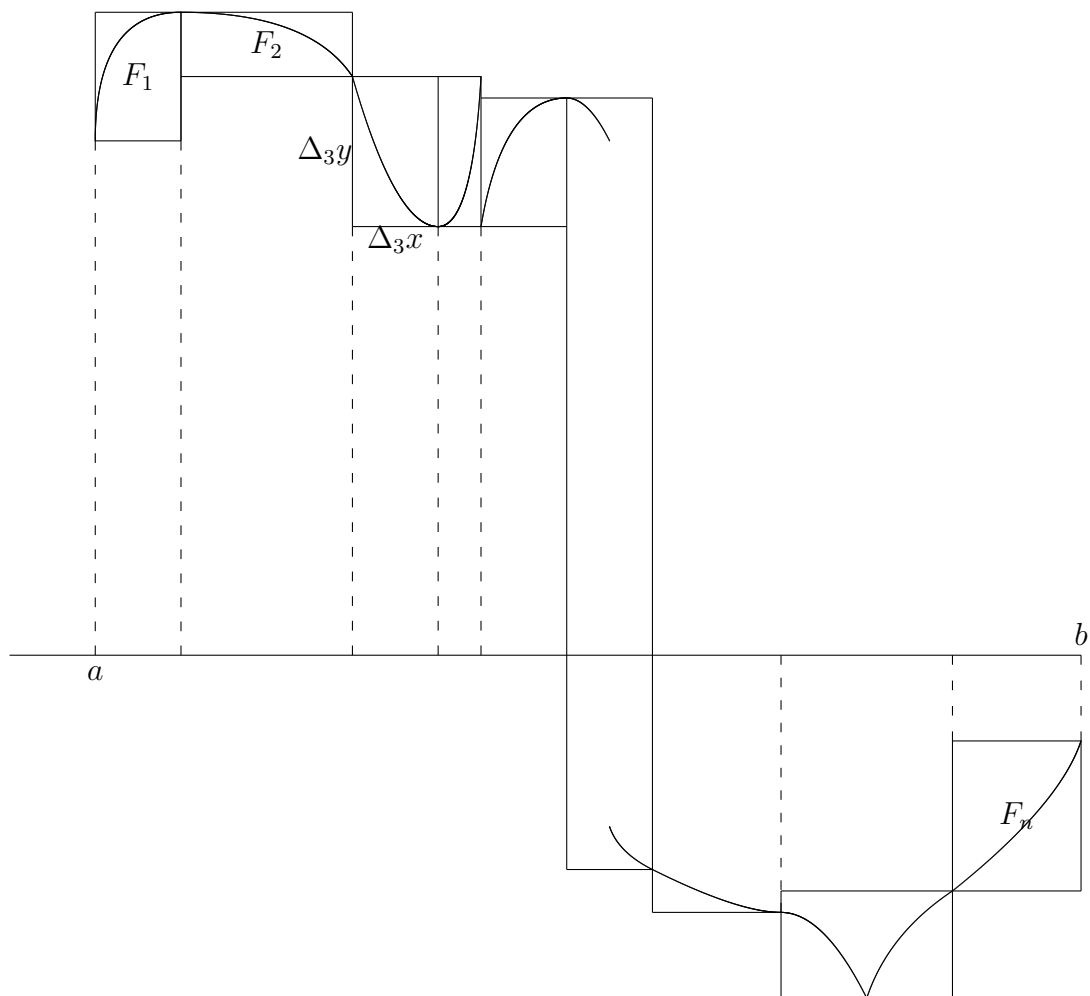

FIG. 22



there were two such values,  $B$  and  $C$ ,  $B > C$ . Let  $\varepsilon = \frac{B-C}{4}$ . By the definition of value approached, for every  $\delta$  there must exist an  $S$  (which we call  $S_B$ ) such that

$$|S_B - B| < \varepsilon \quad (1)$$

and such that the corresponding  $\pi_B$  has its largest  $\Delta_k x < \delta$ . Similarly there must be an  $S_C$  such that

$$|S_C - C| < \varepsilon, \quad (2)$$

and such that the corresponding  $\pi_C$  has its largest  $\Delta_k x < \delta$ . Let  $\pi$  be a partition made up of the points both of  $\pi_B$  and  $\pi_C$ , and let  $S$  be one of the corresponding sums.  $\pi$  is a repartition both of  $\pi_B$  and  $\pi_C$ . Therefore

$$|S - S_C| \leq O_{\pi_C} \quad (3)$$

and

$$|S - S_B| \leq O_{\pi_B}. \quad (4)$$

But since  $f(x)$  is continuous, by the theorem of uniform continuity,  $\delta$  can be so chosen that if any two values of  $x$  differ by less than  $\delta$ , the corresponding values of  $f(x)$  differ by less than  $\frac{\varepsilon}{|b-a|}$  and hence on the partitions  $\pi_B$  and  $\pi_C$ , whose  $\Delta_k x$ 's are all less than  $\delta$ , the corresponding  $\Delta_k y$ 's are all less than  $\frac{\varepsilon}{|b-a|}$ . So we have (since  $\sum_{k=1}^n \Delta_k x = b - a$ )

$$O_{\pi_B} = \sum_{k=1}^n |\Delta_k x| \cdot \Delta_k y < \sum_{k=1}^n |\Delta_k x| \cdot \frac{\varepsilon}{|b-a|} = \varepsilon.$$

Hence

$$O_{\pi_B} < \varepsilon \quad \text{and} \quad O_{\pi_C} < \varepsilon.$$

So we have, since  $\varepsilon = \frac{B-C}{4}$  and  $\delta$  is so chosen that whenever  $|x' - x''| < \delta$ ,  $|f(x') - f(x'')| < \frac{\varepsilon}{|b-a|}$ :

$$\begin{aligned} |S_B - B| &< \varepsilon, \\ |S_C - C| &< \varepsilon, \\ |S_B - S| &< \varepsilon, \\ |S_C - S| &< \varepsilon. \end{aligned}$$

From these inequalities it follows that  $|B - C| < 4\varepsilon$ , which contradicts the statement that  $\varepsilon = \frac{B-C}{4}$ . Hence the hypothesis that  $f(x)$  is not integrable is untenable.

**Theorem 99.** *Every non-oscillating bounded function is integrable.*

**Proof.** The proof runs, as in the preceding theorem, to the paragraph following (4). Let  $D$  and  $d$  be the upper and lower bounds of  $f(x)$ .  $\delta$ , being arbitrary, can be so chosen that  $\delta = \frac{\varepsilon}{D-d}$ . Then

$$O_{\pi_B} = \sum_{k=1}^n \Delta_k y \cdot |\Delta_k x| < \sum_{k=1}^n \Delta_k y \cdot \delta,$$

and since  $f(x)$  is non-oscillating,

$$\sum_{k=1}^n \Delta_k y = D - d.$$

Therefore

$$O_{\pi_B} < (D - d)\delta = \varepsilon.$$

Similarly  $O_{\pi_C} < \varepsilon$ . Hence again we have

$$\begin{aligned} |S_B - B| &< \varepsilon, \\ |S_C - C| &< \varepsilon, \\ |S_B - S| &< \varepsilon, \\ |S_C - S| &< \varepsilon, \end{aligned}$$

and therefore  $|B - C| < 4\varepsilon$ , whereas  $\varepsilon$  was assumed equal to  $\frac{B-C}{4}$ . Thus the hypothesis of a non-integrable non-oscillating function is untenable.

### § 3 Computation of Definite Integrals.

In computing definite integrals it is important to observe that when the integral is known to exist the limit can be calculated on any properly chosen subset of the  $S_\delta$ 's. (See Theorem 41.) So we have that if  $S_{\delta_1}, S_{\delta_2}, \dots$  is any sequence of sums such that  $\lim_{n \rightarrow \infty} \delta_n = 0$ , then

$$\lim_{n \rightarrow \infty} S_{\delta_n} = \int_a^b f(x) dx.$$

One case of this kind occurs when  $\xi_k$  is taken as an end-point of the interval  $\overline{x_{k-1} x_k}$  and all the  $\Delta_k x$ 's are equal. Then we have

$$\int_a^b f(x) dx = \lim_{n \rightarrow \infty} \sum_{k=1}^n f(a + k\Delta x) \Delta x, \text{ where } \Delta x = \frac{b-a}{n}.$$

A simple example of this principle is the proof of the following theorem.

**Theorem 100.** *If  $f(x)$  is a constant,  $C$ , then*

$$\int_a^b C dx = C(b - a).$$

**Proof.** The function  $f(x) = C$  is integrable either according to Theorem 98 or Theorem 99. Hence

$$\int_a^b C dx = \underset{n \neq \infty}{L} \sum_{k=1}^n C \frac{b-a}{n} = \underset{n \neq \infty}{L} n \cdot C \cdot \frac{b-a}{n} = C(b-a).$$

A few other examples follow. In each case the function is known to be integrable by the theorems of § 2.

**Theorem 101.**

$$\int_a^b e^x dx = e^b - e^a.$$

**Proof.** Let

$$\begin{aligned} S_{\Delta x} &= e^a \Delta x + e^{a+\Delta x} \cdot \Delta x + e^{a+2\Delta x} \cdot \Delta x + \dots + e^{a+(n-1)\Delta x} \cdot \Delta x \\ &= e^a \cdot \Delta x [1 + e^{\Delta x} + e^{2\Delta x} + \dots + e^{(n-1)\Delta x}] \\ &= e^a \cdot \Delta x \cdot \frac{e^{n\Delta x} - 1}{e^{\Delta x} - 1} = \frac{e^{b-a} - 1}{e^{\Delta x} - 1} e^a \cdot \Delta x \\ &= (e^b - e^a) \cdot \frac{\Delta x}{e^{\Delta x} - 1}. \end{aligned}$$

Whence the result follows since  $\underset{\Delta x \neq 0}{L} \frac{\Delta x}{e^{\Delta x} - 1} = 1$ . (Differentiate numerator and denominator with respect to  $\Delta x$  according to Theorem 90.)

Instead of arranging the partition-points in an arithmetical progression as in the cases above, we may put them in a geometrical progression, that is, we let

$$\begin{aligned} \left(\frac{b}{a}\right)^{\frac{1}{n}} &= q, \quad \frac{b}{a} = q^n, \\ \Delta_1 x &= aq - a, \quad \Delta_2 x = aq^2 - aq, \dots, \Delta_n x = aq^n - aq^{n-1}, \\ \xi_1 &= a, \quad \xi_2 = aq, \dots, \xi_n = aq^{n-1}, \end{aligned}$$

and obtain the formula

$$\begin{aligned} \int_a^b f(x) dx &= \underset{q \neq 1}{L} a(q-1) [f(a) + qf(aq) + \dots + q^{n-1}f(aq^{n-1})] \\ &= \underset{q \neq 1}{L} a(q-1) \sum_{k=0}^{n-1} q^k f(aq^k). \end{aligned}$$

We apply this scheme to the following.

**Theorem 102.** *In all cases where  $m$  is a whole number  $\neq -1$ , and if  $a > 0$ ,  $b > 0$  for every value of  $m \neq -1$ ,*

$$\int_a^b x^m dx = \frac{b^{m+1} - a^{m+1}}{m+1}.$$

**Proof.**

$$\begin{aligned} \int_a^b x^m dx &= L_{q \neq 1} a(q-1) \sum_{k=0}^{n-1} q^k (aq^k)^m \\ &= a^{m+1} L_{q \neq 1} (q-1) [1 + (q^{m+1}) + (q^{m+1})^2 + \dots + (q^{m+1})^{n-1}] \\ &= a^{m+1} L_{q \neq 1} (q-1) \frac{(q^{m+1})^n - 1}{q^{m+1} - 1} \\ &= L_{q \neq 1} a^{m+1} \{(q^n)^{m+1} - 1\} \frac{q-1}{q^{m+1} - 1} \\ &= (b^{m+1} - a^{m+1}) L_{q \neq 1} \frac{q-1}{q^{m+1} - 1}. \end{aligned} \tag{1}$$

Hence

$$\int_a^b x^m dx = \frac{b^{m+1} - a^{m+1}}{m+1},$$

since

$$L_{q \neq 1} \frac{q-1}{q^{m+1} - 1} = \frac{1}{m+1}.$$

**Theorem 103.**

$$\int_a^b \frac{1}{x} dx = \log b - \log a, \quad (0 < a < b).$$

**Proof.** By equation (1) in the last theorem, since  $q^{m+1} = q^0 = 1$ ,

$$\int_a^b \frac{1}{x} dx = L_{n \neq \infty} n(q-1);$$

but  $n = \frac{\log(\frac{b}{a})}{\log q}$ , hence

$$\int_a^b \frac{1}{x} dx = L_{q \neq 1} \frac{q-1}{\log q} \cdot \log \left( \frac{b}{a} \right) = \log \left( \frac{b}{a} \right) = \log b - \log a,$$

since (§ 6, Chapter VII) L'HOSPITAL's rule gives

$$L_{q \neq 1} \frac{q-1}{\log q} = 1.$$

The following theorem is of frequent use in computing both derivatives and integrals.

**Theorem 104.** *If on an interval  $a$   $b$  two functions  $f(x)$  and  $F(x)$  have the property that for every two values of  $x$ ,  $x_1$  and  $x_2$ , where  $a < x_1 < x_2 < b$ ,*

$$f(x_1)(x_2 - x_1) \leq F(x_2) - F(x_1) \leq f(x_2)(x_2 - x_1);$$

or if

$$f(x_1)(x_2 - x_1) \geq F(x_2) - F(x_1) \geq f(x_2)(x_2 - x_1),$$

then

(1) if  $f(x)$  is continuous,

$$\frac{dF(x)}{dx} = f(x);$$

and

(2) whether  $f(x)$  is continuous or not,

$$\int_a^b f(x)dx \text{ exists and is equal to } F(b) - F(a).$$

**Proof.** We consider first the case

$$f(x_1)(x_2 - x_1) \leq F(x_2) - F(x_1) \leq f(x_2)(x_2 - x_1).$$

This gives

$$f(x_1) \leq \frac{F(x_2) - F(x_1)}{x_2 - x_1} \leq f(x_2).$$

Since  $f(x)$  is continuous at  $x = x_1$ ,  $\lim_{x_2 \rightarrow x_1} f(x_2) = f(x_1)$ . Hence, by Theorem 40 (Corollary 2),

$$\lim_{x_2 \rightarrow x_1} \frac{F(x_2) - F(x_1)}{x_2 - x_1} = f(x_1),$$

which proves (1).

To prove (2) we observe that  $f(x)$  is non-oscillating and therefore integrable according to Theorem 99. On any partition  $\pi$  whose dividing points are  $x_1, x_2, \dots, x_{n-1}$  we have

$$\begin{array}{llll} f(a)(x_1 - a) & \leq F(x_1) - F(a) & \leq f(x_1)(x_1 - a), \\ f(x_1)(x_2 - x_1) & \leq F(x_2) - F(x_1) & \leq f(x_2)(x_2 - x_1), \\ \cdot & \cdot & \cdot \\ \cdot & \cdot & \cdot \\ \cdot & \cdot & \cdot \\ f(x_{n-1})(b - x_{n-1}) & \leq F(b) - F(x_{n-1}) & \leq f(b)(b - x_{n-1}), \end{array}$$

Adding, we get

$$\begin{aligned} f(a)(x_1 - a) + f(x_1)(x_2 - x_1) + \dots + f(x_{n-1})(b - x_{n-1}) &\leq F(b) - F(a) \\ &\leq f(x_1)(x_1 - a) + f(x_2)(x_2 - x_1) + \dots + f(b)(b - x_{n-1}). \end{aligned}$$

But

$$f(a)(x_1 - a) + \dots + f(x_{n-1})(b - x_{n-1}) \geq \underline{BS}_\pi$$

and

$$f(x_1)(x_1 - a) + \dots + f(b)(b - x_{n-1}) \geq \overline{BS}_\pi.$$

Since this holds for every  $\pi$ , we have by Theorem 40 that as (Theorem 99)

$$\begin{aligned} \int_a^b f(x)dx \text{ exists,} \\ \int_a^b f(x)dx = F(b) - F(a). \end{aligned}$$

The proof in case  $f(x_1)(x_2 - x_1) \geq F(x_2) - F(x_1) \geq f(x_2)(x_2 - x_1)$  is identical with the above when we write  $\geq$  instead of  $\leq$ .

## § 4 Elementary Properties of Definite Integrals.

**Theorem 105.** *If  $a < b < c$ , and if a bounded function  $f(x)$  is integrable from  $a$  to  $c$ , then it is integrable from  $a$  to  $b$  and from  $b$  to  $c$ .*

**Proof.** Suppose  $f(x)$  not integrable from  $a$  to  $b$ , then by the definition of a limit (see Chap. II.) there must be a set of values of  ${}_a^b S_\delta$ ,  $[{}_a^b S'_\delta]$ , such that  $\lim_{\delta \rightarrow 0} {}_a^b S'_\delta = A$ , and another set  $[{}_a^b S''_\delta]$  such that  $\lim_{\delta \rightarrow 0} {}_a^b S''_\delta = B$ , while  $A$  and  $B$  are distinct. Whether  $\int_b^c f(x)dx$  exists or not, there must be a set of values of  ${}_b^c S_\delta$ ,  $[{}_b^c S'_\delta]$ , such that the limit  $\lim_{\delta \rightarrow 0} {}_b^c S'_\delta = C$ . Now for every  ${}_a^b S'_\delta$  and  ${}_b^c S'_\delta$  there exists a  ${}_a^c S'_\delta$  such that  ${}_a^c S'_\delta = {}_a^b S'_\delta + {}_b^c S'_\delta$ . Therefore  $A + C$  is a value approached by  ${}_a^c S_\delta$ . By similar reasoning,  $B + C$  is a value approached by  ${}_a^c S_\delta$ . Hence  ${}_a^c S_\delta$  has two values approached, which is contrary to the hypothesis. Hence  $\int_a^b f(x)dx$  must exist. By similar reasoning  $\int_b^c f(x)dx$  must exist.

**Theorem 106.** *If  $a < b < c$  and if a bounded function  $f(x)$  is integrable from  $a$  to  $b$  and from  $b$  to  $c$ , then  $f(x)$  is integrable from  $a$  to  $c$  and  $\int_a^c f(x)dx = \int_a^b f(x)dx + \int_b^c f(x)dx$ .*

**Proof.** Since  $\int_a^b f(x)dx$  and  $\int_b^c f(x)dx$  exist, we know by Theorem 26 that for every  $\varepsilon$  there exists a  $\delta'_\varepsilon$  such that for  ${}_a^b S_\delta$  where  $\delta \leq \delta'_\varepsilon$ ,

$$\left| {}_a^b S_\delta - \int_a^b f(x)dx \right| < \frac{\varepsilon}{3}, \tag{1}$$

and also a  $\delta''_\varepsilon$  such that for every value of  ${}_b^c S_\delta$  where  $\delta \leq \delta''_\varepsilon$ ,

$$\left| {}_b^c S_\delta - \int_b^c f(x)dx \right| < \frac{\varepsilon}{3}. \tag{2}$$

Now if the upper bound of  $f(x)$  on  $\overline{ac}$  is  $M$  and its lower bound is  $m$ , let  $\delta'''_\varepsilon = \frac{\varepsilon}{3(M-m)}$ , and let  $\delta_\varepsilon$ , be smaller than the smallest of  $\delta'_\varepsilon, \delta''_\varepsilon, \delta'''_\varepsilon$ .

Consider any value of  ${}_a^c S_\delta$ . If the point  $b$  is one of the points of the partition upon which  ${}_a^c S_\delta$  is computed, then  ${}_a^c S_\delta$  is the sum of one value of  ${}_a^b S_\delta$  and one value of  ${}_b^c S_\delta$ . If  $b$  is not a point of this partition, let  $\Delta_b x$  be the length of the interval of  ${}_a^c \pi_\delta$  that contains  $b$ . Then for properly chosen  ${}_a^b S_\delta$  and  ${}_b^c S_\delta$

$$\left| {}_a^b S_\delta + {}_b^c S_\delta - {}_a^c S_\delta \right| < \Delta_b x (M - m) < \frac{\varepsilon}{3}. \tag{3}$$

So in every case (whether or not  $b$  is a partition-point of  ${}_a^c \pi_\delta$ ) by combining (1), (2), and (3) we obtain the result that for every  $\varepsilon$  there exists a  $\delta_\varepsilon$  such that for every  ${}_a^c S_{\delta_\varepsilon}$

$$\left| {}_a^c S_{\delta_\varepsilon} - \int_a^b f(x)dx - \int_b^c f(x)dx \right| < \varepsilon.$$

Therefore

$$L_{\delta \doteq 0} {}_a^c S_\delta = \int_a^b f(x)dx + \int_b^c f(x)dx,$$

which proves the theorem.

**Theorem 107.** *Provided both integrals exist,<sup>3</sup> and  $a < b$ ,*

$$\int_a^b |f(x)|dx \geq \left| \int_a^b f(x)dx \right|.$$

**Proof.**

$$\sum |f(\xi_k)|\Delta_k x \geq \left| \sum f(\xi_k)\Delta_k x \right|.$$

Hence for every  $S_\delta |f(x)|$  there is a smaller or equal  $S_\delta f(x)$ , the  $\delta$ 's being the same. Hence by Corollary 2, Theorem 40,

$$L_{\delta \doteq 0} S_\delta |f(x)| \geq \left| L_{\delta \doteq 0} S_\delta f(x) \right|.$$

---

<sup>3</sup>That the first integral exists if the second exists is shown in Theorem 135.

**Theorem 108.** *If  $\int_a^b f(x)dx$  exists, then  $\int_b^a f(x)dx$  exists and*

$$\int_a^b f(x)dx = - \int_b^a f(x)dx.$$

**Proof.** This is a consequence of the theorem (Corollary 1 Theorem 27) that

$$L_{x \dot{=} a}(-f(x)) = - L_{x \dot{=} a} f(x),$$

for to every  $S$  used in defining  $\int_a^b f(x)dx$  corresponds a sum equal to  $-S$  which is used in defining  $\int_b^a f(x)dx$ .

Similarly to every  $S'$  used in defining  $\int_b^a f(x)dx$  there corresponds a sum  $-S'$  used in defining  $\int_a^b f(x)dx$ . Hence the function  $S_\delta$  in the definition of  $\int_a^b f(x)dx$  is the negative of the function  $S_\delta$  used in the definition of  $\int_b^a f(x)dx$ . Hence the theorem follows from the theorem quoted.

We adjoin the following two theorems, the first of which is an immediate consequence of the definition of an integral, and the second a corollary of Theorems 105, 106, and 108.

**Theorem 109.**  *$\int_{a+h}^{b+h} f(x-h)dx$  exists and is equal to  $\int_a^b f(x)dx$ , provided the latter integral exists.*<sup>4</sup>

**Theorem 110.** *If any two of the following integrals exist, so does the third, and*

$$\int_a^b f(x)dx + \int_b^c f(x)dx = \int_a^c f(x)dx.$$

**Theorem 111.** *If  $C$  is any constant and if  $f(x)$  is integrable on  $a$   $\overline{b}$ , then  $Cf(x)$  is integrable on  $a$   $\overline{b}$  and*

$$\int_a^b Cf(x)dx = C \int_a^b f(x)dx.$$

**Proof.**

$$S_\delta = \sum_{k=1}^n f(\xi_k) \Delta_k x$$

<sup>4</sup>First stated formally by H. LEBESGUE, *Leçons sur l'Intégration*, Chapter VII, page 98.



is an  $S_\delta$  of the set which defines  $\int_a^b f(x)dx$  and

$$S'_\delta = \sum_{k=1}^n Cf(\xi_k)\Delta_kx$$

is the corresponding  $S_\delta$  of the set which defines  $\int_a^b Cf(x)dx$ . Hence our theorem follows immediately from Theorem 34, a special case of which is  $\int_{x=a}^b Cf(x) = C \int_{x=a}^b f(x)$ .

**Theorem 112.** *If  $f_1(x)$  and  $f_2(x)$  are any two functions each integrable on the interval  $\int_a^b$ , then  $f(x) = f_1(x) \pm f_2(x)$  is integrable on  $\int_a^b$  and*

$$\int_a^b f(x)dx = \int_a^b f_1(x)dx \pm \int_a^b f_2(x)dx.$$

**Proof.** The proof depends directly upon the theorem that if  $\int_{x=a}^b \phi_1(x) = b_1$ , and  $\int_{x=a}^b \phi_2(x) = b_2$ , then  $\int_{x=a}^b (\phi_1(x) \pm \phi_2(x)) = b_1 \pm b_2$  (Theorem 34).

**Theorem 113.** *If  $f_1(x)$  and  $f_2(x)$  are integrable on  $\int_a^b$  and such that for every value of  $x$  on  $\int_a^b$   $f_1(x) \geq f_2(x)$ , then*

$$\int_a^b f_1(x)dx \geq \int_a^b f_2(x)dx.$$

**Proof.** Since  $S_1$  is always greater than or equal to  $S_2$ , then, by Theorem 34,  $\int_{\delta=0} S_1 \geq \int_{\delta=0} S_2$ , which proves the theorem.

**Theorem 114.** (*Maximum-Minimum Theorem.*) *If*

- (1) *the product  $f_1(x) \cdot f_2(x)$  and the factor  $f_1(x)$  are integrable on  $\int_a^b$ ,*
- (2)  *$f_1(x)$  is always positive or always negative on  $\int_a^b$ ,*
- (3)  *$M$  and  $m$  are the least upper and the greatest lower bounds respectively of  $f_2(x)$  on  $\int_a^b$ ,*

then

$$m \cdot \int_a^b f_1(x)dx \leq \int_a^b f_1(x) \cdot f_2(x)dx \leq M \cdot \int_a^b f_1(x)dx,$$

or

$$m \cdot \int_a^b f_1(x)dx \geq \int_a^b f_1(x) \cdot f_2(x)dx \geq M \cdot \int_a^b f_1(x)dx.$$

**Proof.** By Theorem 111,

$$M \cdot \int_a^b f_1(x)dx = \int_a^b M \cdot f_1(x)dx$$

and

$$m \cdot \int_a^b f_1(x)dx = \int_a^b m \cdot f_1(x)dx.$$

But in case  $f_1(x)$  is always positive,

$$m \cdot f_1(x) \leq f_1(x) \cdot f_2(x) \leq M \cdot f_1(x).$$

Hence, by the preceding theorem,

$$\int_a^b m \cdot f_1(x)dx \leq \int_a^b f_1(x) \cdot f_2(x)dx \leq \int_a^b M \cdot f_1(x)dx,$$

and therefore

$$m \cdot \int_a^b f_1(x)dx \leq \int_a^b f_1(x) \cdot f_2(x)dx \leq M \cdot \int_a^b f_1(x)dx.$$

If  $f_1(x)$  is always negative, it follows in the same manner that

$$m \cdot \int_a^b f_1(x)dx \geq \int_a^b f_1(x) \cdot f_2(x)dx \geq M \cdot \int_a^b f_1(x)dx.$$

As an obvious corollary of this theorem we have the Mean-value Theorem:

**Theorem 115.** Under the hypothesis of Theorem 114 there exists a number  $K$ ,  $m \leq K \leq M$ , such that

$$\int_a^b f_1(x) \cdot f_2(x)dx = K \int_a^b f_1(x)dx.$$

*Corollary 1.* In case  $f_2(x)$  is continuous we have a value  $\xi$  of  $x$  on  $\overline{ab}$  such that

$$\int_a^b f_1(x) \cdot f_2(x)dx = f_2(\xi) \int_a^b f_1(x)dx.$$

In case  $f_1(x) = 1$ ,

$$\int_a^b f_1(x)dx = b - a,$$

and the theorem reduces to this:

**Theorem 116.** If  $f(x)$  is any integrable function on the interval  $a$   $\overline{b}$ , there exists a number  $M$  lying between the upper and lower bounds of  $f(x)$  on  $a$   $\overline{b}$  such that

$$\int_a^b f(x)dx = M(b-a),$$

and if  $f(x)$  is continuous, there is a value  $\xi$  of  $x$  on  $a$   $\overline{b}$  such that

$$\int_a^b f(x)dx = f(\xi)(b-a).$$

In many applications of the integral calculus the expression

$$\frac{\int_a^b f(x)dx}{b-a}$$

represents the notion of an average value of the dependent variable  $y = f(x)$  as  $x$  varies from  $a$  to  $b$ . An average of an infinite set of values of  $f(x)$  is of course to be described only by means of a limiting process. Consider a set of points  $x_1, x_2, \dots, x_{n-1}, x_n = b$  on the interval  $a$   $\overline{b}$  such that

$$x_1 - a = x_2 - x_1 = x_3 - x_2 = \dots = x_{n-1} - x_{n-2} = b - x_{n-1}.$$

Then

$$M_n = \frac{1}{n} \sum_{k=1}^n f(x_k),$$

and we define the mean value of  $f(x)$ ,  $\lim_{n \rightarrow \infty} M_n$  if this limit exists. But  $x_{k+1} - x_k = \frac{b-a}{n} = \Delta x$ .

If the definite integral  $\int_a^b f(x)dx$  exists, we may write

$$\int_a^b f(x)dx = \lim_{\delta \rightarrow 0} S_\delta,$$

where

$$S_\delta = \sum_{k=1}^n f(x_k) \Delta x = \sum_{k=1}^n f(x_k) \frac{b-a}{n} = \frac{b-a}{n} \sum_{k=1}^n f(x_k) = (b-a)M_n.$$

Therefore

$$\lim_{\delta \rightarrow 0} S_\delta = (b-a) \lim_{n \rightarrow \infty} M_n.$$

We therefore have the theorem:

**Theorem 117.** In case the integral of  $f(x)$  exists on the interval  $\overline{ab}$ ,

$${}_a^b M f(x) = \frac{\int_a^b f(x) dx}{b-a}.$$

We note that  ${}_a^b M$  is the same as the  $K$  which occurs in the mean-value theorem, and that the last theorem suggests a simple method of approximating the value of a definite integral by multiplying the average of a finite number of ordinates by  $b - a$ .

## § 5 The Definite Integral as a Function of the Limits of Integration.

**Theorem 118.** If  $f(x)$  is integrable on an interval  $\overline{ab}$ , and if  $x$  is any point of  $\overline{ab}$ ,  $\int_a^x f(x) dx$  is a continuous function of  $x$ .

**Proof.**  $\int_a^x f(x) dx$  exists, by Theorem 105, and by the definition of a continuous function we need only to show that

$$\lim_{x' \rightarrow x} \left( \int_a^{x'} f(x) dx - \int_a^x f(x) dx \right) = 0.$$

By the theorems of the preceding section,

$$\int_a^{x'} f(x) dx - \int_a^x f(x) dx = \int_x^{x'} f(x) dx \leq |x' \overline{B}_x \cdot (x' - x)| \leq |\overline{B} \cdot (x' - x)|,$$

where  $x' \overline{B}_x$  stands for the least upper bound of  $f(x)$  on the interval  $\overline{xx'}$ , and  $\overline{B}$  for the least upper bound of  $f(x)$  on  $\overline{ab}$ . Since  $\overline{B}$  is a constant,  $\overline{B}(x' - x)$  approaches zero as  $x'$  approaches  $x$ , and therefore by Theorem 40, Corollary 4, the conclusion of our theorem follows.

**Theorem 119.** If  $f(x)$  is continuous on an interval  $\overline{ab}$ ,  $\int_a^x f(x) dx$  ( $a < x < b$ ) possesses a derivative with respect to  $x$  such that

$$\frac{d}{dx} \int_a^x f(x) dx = f(x).$$

**Proof.** By the preceding theorem  $\int_a^x f(x)dx$  is continuous. To form the derivative we investigate the expression

$$\frac{\int_a^{x'} f(x)dx - \int_a^x f(x)dx}{x' - x} = \frac{\int_x^{x'} f(x)dx}{x' - x} \quad (1)$$

as  $x'$  approaches  $x$ .

By Theorem 115 (the mean-value theorem),

$$\int_x^{x'} f(x)dx = f(\xi(x'))(x' - x),$$

where  $\xi(x')$  is a value of  $x$  between  $x$  and  $x'$  and is a function of  $x'$ . Hence (1) is equal to

$$f(\xi). \quad (2)$$

But as  $x'$  approaches  $x$ ,  $\xi$  also approaches  $x$  and so, by Theorem 39, as  $x'$  approaches  $x$ , (2) approaches  $f(x)$ . Therefore

$$\lim_{x' \rightarrow x} \frac{\int_a^{x'} f(x)dx - \int_a^x f(x)dx}{x' - x} = f(x) = \frac{d}{dx} \int_a^x f(x)dx.$$

Following is a more general statement of Theorem 119.

*Corollary.*—If  $f(x)$  is continuous at a point  $x_1$  of  $\overline{a b}$  and integrable on  $\overline{a b}$ , then at  $x = x_1$

$$\frac{d}{dx} \int_a^x f(x)dx = f(x).$$

The proof is like that of Theorem 112 except that

$$\int_{x_1}^x f(x)dx = (x - x_1)M(x),$$

and  $M(x)$  is a value between the upper and lower bounds of  $f(x)$  on  $\overline{x_1 x}$ . But by the continuity of  $f(x)$  at  $x_1$

$$\lim_{x \rightarrow x_1} M(x) = f(x_1),$$

and hence the conclusion follows as in the theorem.

**Theorem 120.** If  $f(x)$  is any continuous function on the interval  $a$   $\overline{b}$ , and  $F(x)$  any function on this interval such that

$$\frac{d}{dx}F(x) = f(x),$$

then  $F(x)$  differs from  $\int_a^x f(x)dx$  at most by an additive constant.

**Proof.** Let  $F(x) = \int_a^x f(x)dx + \phi(x)$ .

Since  $F(x)$  and  $\int_a^x f(x)dx$  are both differentiable,

$$\frac{d}{dx}F(x) = \frac{d}{dx} \left( \int_a^x f(x)dx + \phi(x) \right) = \frac{d}{dx} \left( \int_a^x f(x)dx \right) + \frac{d}{dx}\phi(x).$$

By the preceding theorem

$$\frac{d}{dx} \int_a^x f(x)dx = f(x).$$

Hence  $\frac{d}{dx}\phi(x) = 0$ , whence, by Theorem 94,  $\phi(x)$  is a constant.

**Theorem 121.** If  $f(x)$  is a continuous function on an interval  $a$   $\overline{b}$  and  $F(x)$  is such that

$$\frac{d}{dx}F(x) = f(x),$$

then

$$\int_a^b f(x)dx = F(b) - F(a).$$

**Proof.** By the last theorem,

$$\int_a^x f(x)dx = F(x) + c.$$

But

$$0 = \int_a^a f(x)dx = F(a) + c.$$

Therefore

$$-F(a) = c.$$

Whence

$$\int_a^b f(x)dx = F(b) + c = F(b) - F(a).$$

The symbol  $[F(x)]_a^b$  or  ${}_a^bF(x)$  is frequently used for  $F(b) - F(a)$ . In these terms the above theorem is expressed by the equation

$$\int_a^b f(x)dx = {}_a^bF(x).$$

By this last theorem the theory of definite and indefinite integrals is united as far as continuous functions are concerned, and a table of derivatives gives a table of integrals. For discontinuous functions the correspondence does not in general hold. That is, there are on the one hand integrable functions  $f(x)$  such that  $\int_a^x f(x)dx$  is not differentiable with respect to  $x$ , and on the other hand differentiable functions  $\phi(x)$  such that  $\phi'(x)$  is not integrable.<sup>5</sup>

## § 6 Integration by Parts and by Substitution.

The formulas for integration by parts and by substitution are ordinarily written as follows:

$$\int u dv = uv - \int v du,$$

$$\int f(y) dy = \int f(y) \cdot \frac{dy}{dx} \cdot dx.$$

The following theorems state sufficient conditions for their validity.

**Theorem 122.** (*Integration by parts.*)

$$\int_a^b f_1(x) \cdot f_2'(x) dx = [f_1(x) \cdot f_2(x)]_a^b - \int_a^b f_2(x) \cdot f_1'(x) dx,$$

provided  $f_1'(x)$  and  $f_2'(x)$  exist and are continuous on the interval  $a \overline{b}$ .

**Proof.** By Theorem 75,

$$\frac{d}{dx} (f_1(x) \cdot f_2(x)) = f_1(x) \cdot f_2'(x) + f_2(x) \cdot f_1'(x).$$

Therefore

$$\int_a^b \frac{d}{dx} (f_1(x) \cdot f_2(x)) dx = \int_a^b f_1(x) \cdot f_2'(x) dx + \int_a^b f_2(x) \cdot f_1'(x) dx.$$

(The integral exists since it follows from the existence and continuity of  $f_1'(x)$  and  $f_2'(x)$  that  $f_1(x)$  and  $f_2(x)$  are continuous). By Theorem 121,

$$\int_a^b \frac{d}{dx} \{f_1(x) \cdot f_2(x)\} dx = f_1(b) \cdot f_2(b) - f_1(a) \cdot f_2(a).$$

Therefore

$$\int_a^b f_1(x) \cdot f_2'(x) dx = [f_1(x) \cdot f_2(x)]_a^b - \int_a^b f_2(x) \cdot f_1'(x) dx.$$

---

<sup>5</sup>For a good discussion of this subject the reader is referred to H. LEBESGUE, *Leçons sur l'Intégration*.

**Theorem 123.** (*Integration by substitution.*) If  $y = \phi(x)$  has a continuous derivative at every point of  $\overline{a, b}$  and  $f(y)$  is continuous for all values taken by  $y = \phi(x)$  as  $x$  varies from  $a$  to  $b$ ,

$$\int_A^B f(y)dy = \int_a^b f(y)\frac{dy}{dx}dx,$$

where  $A = \phi(a)$ ,  $B = \phi(b)$ .

**Proof.** By Theorem 120 and by Theorem 79,

$$\int_A^{\phi(x)} f(y)dy = \int_a^x \frac{d}{dx} \left( \int_A^{\phi(x)} f(y)dy \right) dx + C = \int_a^x f(y)\frac{dy}{dx} \cdot dx + C,$$

$C$  being an arbitrary constant.  $C$  is determined by letting  $x = a$ . Then if  $x = b$  we have

$$\int_A^B f(y)dy = \int_a^b f(y)\frac{dy}{dx} \cdot dx.$$

**Theorem 124.**

$$\int_a^b f(x)dx = \int_A^B f(\phi(y))\frac{dx}{dy}dy,$$

where  $x = \phi(y)$  and  $a = \phi(A)$ ,  $b = \phi(B)$ ; provided that both integrals exist, and that  $\phi(y)$  is non-oscillating and has a finite derivative.

**Proof.**

$$\int_a^b f(x)dx = L \sum_{n \rightarrow \infty}^n f(\xi_k)\Delta_k x \quad (1)$$

whenever the least upper bound of  $\Delta_k x$  for each  $n$  approaches zero as  $n$  approaches  $+\infty$ . Now let  $\Delta y = \frac{B-A}{n}$ ,

$$\begin{aligned} y_k &= A + k \cdot \Delta y, \\ \phi(y_k) - \phi(y_{k-1}) &= \Delta_k x. \end{aligned}$$

Hence, by Theorem 85,

$$\Delta_k x = \phi'(\eta_k)\Delta y,$$

where  $\eta_k$  lies between  $y_k$  and  $y_{k-1}$ . Now if  $\xi_k = \phi(\eta_k)$ , it will lie between  $\phi(y_k)$  and  $\phi(y_{k-1})$ ; moreover the  $\Delta_k x$ 's are all of the same sign or zero; and since the hypothesis makes  $\phi(y)$  uniformly continuous, their least upper bound approaches zero as  $n$  approaches  $+\infty$ . Therefore

$$\begin{aligned} \int_a^b f(x)dx &= L \sum_{n \rightarrow \infty}^n f(\xi_k)\Delta_k x \\ &= L \sum_{n \rightarrow \infty}^n f(\phi(\eta_k)) \cdot \phi'(\eta_k) \cdot \Delta y \\ &= \int_A^B f(\phi(y))\phi'(y)dy, \end{aligned}$$



provided the latter integral exists. Hence

$$\int_a^b f(x)dx = \int_A^B f(\phi(y)) \cdot \frac{dx}{dy} dy.$$

*Corollary.*—The validity of this theorem remains if  $\phi(y)$  has a finite number of oscillations.

**Proof.** Suppose the maximum and minimum values of  $\phi(y)$  are

$$a_1, a_2, a_3, \dots, a_n,$$

corresponding to the values of  $y$ ,

$$A_1, A_2, A_3, \dots, A_n.$$

Then we have

$$\begin{aligned} \int_a^b f(x)dx &= \int_a^{a_1} f(x)dx + \int_{a_1}^{a_2} f(x)dx + \dots + \int_{a_n}^b f(x)dx \\ &= \int_A^{A_1} f(\phi(x)) \frac{dx}{dy} dy + \int_{A_1}^{A_2} f(\phi(x)) \frac{dx}{dy} dy \dots + \int_{A_n}^B f(\phi(x)) \frac{dx}{dy} dy \\ &= \int_A^B f(\phi(x)) \frac{dx}{dy} dy. \end{aligned}$$

The form of this proposition given in Theorem 123 would permit an infinitude of oscillations of  $\phi(y)$ .

## § 7 General Conditions for Integrability.

The following lemmas are to be associated with those on pages 124 and 125.

**Lemma 3.**—If  $\pi_1$  is a repartition of  $\pi$ , then for any function bounded on  $a$   $\overline{b}$

$$O_{\pi_1} \leq O_{\pi}.$$

**Proof.** Any interval  $\Delta_k x$  of  $\pi$  is composed of one or more intervals  $\Delta'_k x$ ,  $\Delta''_k x$ , etc., of  $\pi_1$ , and these contribute to  $O_{\pi_1}$  the terms

$$|\Delta'_k x| \Delta'_k y + |\Delta''_k x| \Delta''_k y + \dots \quad (1)$$

The corresponding term of  $O_{\pi}$  is

$$|\Delta_k x| \Delta_k y = |\Delta'_k x| \Delta_k y + |\Delta''_k x| \Delta_k y + \dots \quad (2)$$

Since each of  $\Delta'_k y$ ,  $\Delta''_k y$ , etc., is less than or equal to  $\Delta_k y$ , (1) is less than or equal to (2), and hence  $O_{\pi_1} \leq O_{\pi}$ .

**Lemma 4.**—If  $\pi_0$  is any partition of the interval  $a \overset{|-|}{b}$ , and  $\varepsilon_0$  any positive number, then for any bounded function there exists a number  $\delta_0$  such that for every partition  $\pi$  whose greatest  $\Delta$  is less than  $\delta_0$

$$O_{\pi_0} + \varepsilon_0 \geq O_{\pi}.$$

**Proof.** We prove the lemma by showing that if  $\pi_0$  has  $N + 1$  partition points  $x_0, x_1, x_2, \dots, x_N$ , an effective choice of  $\delta_0$  is

$$\delta_0 = \frac{\varepsilon_0}{R \cdot N},$$

where  $R$  is the oscillation of the function on  $a \overset{|-|}{b}$ .

Of the intervals of  $\pi$  there are at most  $N - 1$  which contain as interior points, points of  $x_0, x_1, x_2, \dots, x_N$ . Denote the lengths of these intervals of  $\pi$  by  $\Delta_p x$ , and denote by  $\Delta_q x$  the lengths of the intervals of  $\pi$  which contain as interior points no points of  $x_0, x_1, x_2, \dots, x_N$ . Then

$$O_{\pi} = \sum_p |\Delta_p x| \cdot \Delta_p y + \sum_q |\Delta_q x| \cdot \Delta_q y.$$

If  $\pi'$  is a repartition of  $\pi_0$  obtained by introducing the points of  $\pi$ , then

$$\sum_q |\Delta_q x| \cdot \Delta_q y$$

is a subset of the terms whose sum constitutes  $O_{\pi'}$ . Hence, by Lemma 3,

$$\sum_q |\Delta_q x| \cdot \Delta_q y \leq O_{\pi'} \leq O_{\pi_0}.$$

Since

$$|\Delta_p x| \leq \delta_0 = \frac{\varepsilon_0}{R \cdot N},$$

it follows that

$$\sum_p |\Delta_p x| \cdot \Delta_p y \leq \varepsilon_0.$$

Therefore

$$O_{\pi_0} + \varepsilon_0 \geq O_{\pi}.$$

**Lemma 5.**—If  $\pi$  is any partition,  $O_{\pi}$  is the least upper bound of the expression

$$S'_{\pi} - S''_{\pi},$$

where  $S'_{\pi}$  and  $S''_{\pi}$  may be any two values of  $S_{\pi}$  corresponding to different choices of the  $\xi$ 's.

**Proof.** Without loss of generality we may assume every  $\Delta_k x$  positive.

Then

$$\overline{B}S_{\pi} - \underline{B}S_{\pi} = \overline{B} |S'_{\pi} - S''_{\pi}|.$$

But

$$\overline{B}S_\pi = \overline{B} \left\{ \sum_{k=1}^n f(\xi_k) \cdot \Delta_k x \right\} = \sum_{k=1}^n \{ \overline{B}f(\xi_k) \} \Delta_k x$$

and

$$\underline{B}S_\pi = \underline{B} \left\{ \sum_{k=1}^n f(\xi_k) \cdot \Delta_k x \right\} = \sum_{k=1}^n \{ \underline{B}f(\xi_k) \} \Delta_k x.$$

Therefore

$$\begin{aligned} \overline{B}S_\pi - \underline{B}S_\pi &= \sum_{k=1}^n [\overline{B}f(\xi_k) - \underline{B}f(\xi_k)] \Delta_k x \\ &= \sum_{k=1}^n \Delta_k y \cdot \Delta_k x = O_\pi. \end{aligned}$$

Therefore

$$\overline{B}(S'_\pi - S''_\pi) = O_\pi.$$

**Theorem 125.** *A necessary and sufficient condition that a function  $f(x)$ , defined, single-valued, and bounded on an interval  $a$   $b$  shall be integrable on  $a$   $b$ , is that the greatest lower bound of  $O_\pi$  for this function shall be zero.*

**Proof.** We first show that if  $f(x)$  is integrable the lower bound of  $O_\pi$  is zero. By hypothesis,

$$\int_a^b f(x) dx = \lim_{\delta \rightarrow 0} S_\delta$$

exists. By Theorem 27, Chapter IV, this implies that for every  $\varepsilon$  there exists a  $\delta_\varepsilon$  such that for every  $\delta_1 < \delta_\varepsilon$  and  $\delta_2 < \delta_\varepsilon$

$$|S_{\delta_1} - S_{\delta_2}| < \varepsilon.$$

Hence, if  $\pi$  be a partition whose intervals  $\Delta_k x$  are all less than  $\delta_\varepsilon$ , we must have

$$|S'_\pi - S''_\pi| < \varepsilon$$

for every  $S'_\pi$  and  $S''_\pi$ . By Lemma 5 this implies that  $O_\pi \leq \varepsilon$ . But if for every  $\varepsilon$  there exists a  $\pi$  such that  $O_\pi \leq \varepsilon$ , then

$$\underline{B}O_\pi = 0.$$

Secondly, we show that if the lower bound of  $O_\pi$  is zero,  $S_\delta$  converges to a single value,

$$\int_a^b f(x) dx,$$

as  $\delta$  approaches zero. Given any positive quantity  $\varepsilon$  there exists a partition  $\pi_\varepsilon$ , such that  $O_{\pi_\varepsilon} < \frac{\varepsilon}{4}$ . By Lemma 4 there exists a  $\delta_\varepsilon$  such that for every  $\pi$  whose intervals are numerically less than  $\delta_\varepsilon$

$$O_\pi \leq O_{\pi_\varepsilon} + \frac{\varepsilon}{4} < \frac{\varepsilon}{2}.$$

Now let  $S_{\pi'_\varepsilon}$  and  $S_{\pi''_\varepsilon}$  be any two values of  $S_{\delta_\varepsilon}$ , and let  $\pi'''_\varepsilon$  be the partition composed of the points of both  $\pi'_\varepsilon$  and  $\pi''_\varepsilon$ . Then for any value of  $S_{\pi'''_\varepsilon}$  we have, by Lemma 2,

$$\begin{aligned} |S_{\pi'_\varepsilon} - S_{\pi'''_\varepsilon}| &\leq O_{\pi'_\varepsilon} < \frac{\varepsilon}{2}, \\ |S_{\pi''_\varepsilon} - S_{\pi'''_\varepsilon}| &\leq O_{\pi''_\varepsilon} < \frac{\varepsilon}{2}. \end{aligned}$$

Therefore

$$|S_{\pi'_\varepsilon} - S_{\pi''_\varepsilon}| < \varepsilon.$$

Hence for every  $\varepsilon$  we have a  $\delta_\varepsilon$  such that for every two values of  $S_\delta$ ,  $\delta < \delta_\varepsilon$ ,

$$|S_{\pi'_\varepsilon} - S_{\pi''_\varepsilon}| < \varepsilon.$$

By Theorem 27, this implies the existence of  $\lim_{\delta \rightarrow 0} S_\delta$ .

In case the definite integral does not exist it is sometimes desirable to use the upper and lower bounds of indeterminateness of  $S_\delta$  as  $\delta$  approaches zero. These are denoted respectively by the symbols  $\overline{\int_a^b} f(x)dx$  and  $\underline{\int_a^b} f(x)dx$ <sup>6</sup> and are called the upper and lower definite integrals of  $f(x)$ . They are both equal to

$$\int_a^b f(x)dx$$

if and only if the latter integral exists. They are usually defined by the equations

$$\overline{\int_a^b} f(x)dx = \underline{B}\overline{S}_\pi,$$

where  $\overline{S}_\pi = \sum_{k=1}^n \{\overline{B}f(\xi_k)\} \Delta_k x$  for all partitions of  $\pi$ , and

$$\underline{\int_a^b} f(x)dx = \overline{B}\underline{S}_\pi,$$

---

<sup>6</sup>For a more extended theory of these integrals, cf. PIERPONT, page 337.

where  $\underline{S}_\pi = \sum_{k=1}^n \{\underline{B}f(\xi_k)\} \Delta_k x$  for all partitions of  $\pi$ .

That  $\int_a^b f(x)dx$  exists when the upper and lower integrals are equal is evident under this definition, because

$$O_\pi = \overline{S}_\pi - \underline{S}_\pi,$$

and thus  $\underline{B}O_\pi = 0$  if and only if

$$\int_a^{\overline{b}} f(x)dx = \int_{\underline{a}}^b f(x)dx.$$

For every value of  $\delta > 0$  there is an infinite set of partitions  $\pi$ , for which the largest  $\Delta_k x$  is less than  $\delta$ , and for each of these there is a value of  $O_\pi$ . If  $O_\delta$  stands for any such  $O_\pi$ , then  $O_\delta$  is a many-valued function of  $\delta$ .

**Theorem 126.** *A necessary and sufficient condition that a function  $f(x)$ , defined, single-valued, and bounded on an interval  $\overline{a} \overline{b}$ , is integrable is that*

$$\lim_{\delta \rightarrow 0} O_\delta = 0.$$

**Proof.** *The condition is necessary.*

By Theorem 125 the integrability of  $f(x)$  implies  $\underline{B}O_\pi = 0$ . Hence for every  $\varepsilon$  there exists a partition  $\pi$  such that

$$O_\pi < \varepsilon.$$

By Lemma 4 there exists a  $\delta_\varepsilon$  such that for every  $\pi'$  whose greatest  $\Delta x$  is less than  $\delta_\varepsilon$

$$O_{\pi'} < O_\pi + \varepsilon < 2\varepsilon.$$

Hence

$$\lim_{\delta \rightarrow 0} O_\delta = 0.$$

*The condition is sufficient.*

Since

$$\lim_{\delta \rightarrow 0} O_\delta = 0,$$

and  $O_\delta > 0$ ,

$$\underline{B}O_\pi = 0.$$

Hence the function is integrable by Theorem 125.

**Theorem 127.** *A necessary and sufficient condition that a function, defined, single-valued, and bounded on an interval  $\overline{a} \overline{b}$ , shall be integrable on that interval is that for every pair of positive numbers  $\sigma$  and  $\lambda$  there exists a partition  $\pi$  such that the sum of the lengths of those intervals on which the oscillation of the function is greater than  $\sigma$  is less than  $\lambda$ .*

**Proof.** *The condition is necessary.*

If for a given pair of positive numbers  $\sigma$  and  $\lambda$  there exists no  $\pi$  such as is required by the theorem, then  $O_\pi > \sigma \cdot \lambda$  for every  $\pi$ , which is contrary to the conclusion of Theorem 125 that

$$\underline{B}O_\pi = 0.$$

*The condition is sufficient.*

For a given positive  $\varepsilon$  choose  $\sigma$  and  $\lambda$  so that

$$\sigma(b-a) < \frac{\varepsilon}{2} \text{ and } \lambda \cdot R < \frac{\varepsilon}{2},$$

where  $R$  is the oscillation of the function on  $a b$ . Let  $\pi$  be a partition such that the sum of the lengths of those intervals on which the oscillation of the function is greater than  $\sigma$  is less than  $\lambda$ . Then the sum of the terms of  $O_\pi$  which occur on these intervals is less than

$$\lambda \cdot R,$$

and the sum of the terms of  $O_\pi$  on the remaining intervals is less than

$$\sigma(b-a).$$

Therefore

$$O_\pi < \lambda \cdot R + \sigma(b-a) < \varepsilon.$$

Hence

$$\underline{B}O_\pi = 0,$$

whence by Theorem 125 the integral exists.

**Definition.**—The *content* of a set of points  $[x]$  on an interval  $a b$  is a number  $C[x]$  defined as follows: Let  $\pi$  be any partition of  $a b$ , none of the partition points of which are points of  $[x]$ , and  $D_\pi$  the sum of the lengths of those intervals of  $\pi$  which contain points of  $[x]$  as interior points. Then

$$\underline{B}D_\pi = C[x].$$

An important special case is where

$$C[x] = 0.$$

It is evident that if a set  $[x]$  has content zero, for every  $\varepsilon$  there exists a finite set of segments of lengths

$$\varepsilon_1, \varepsilon_2, \varepsilon_3, \dots, \varepsilon_n$$

which contain every point  $[x]$  and such that

$$\sum_{i=1}^n \varepsilon_i < \varepsilon.$$

It is also evident that if the sets  $[x_1]$  and  $[x_2]$  are of content zero, then the set of all  $x_1$  and  $x_2$  is of content zero.<sup>7</sup>

**Theorem 128.** *A necessary and sufficient condition for the integrability of a function  $f(x)$  on an interval  $a b$  is that for every  $\sigma > 0$  the set of points  $[x_\sigma]$  at which the oscillation of  $f(x)$  is greater than or equal to  $\sigma$  shall be of content zero.<sup>8</sup>*

**Proof.** If at every point of an interval  $c d$  the oscillation of  $f(x)$  is less than  $\sigma$ , then about each point of  $c d$  there is a segment upon which the oscillation is less than  $\sigma$ , and hence by Theorem 11, Chapter II, there is a partition of  $c d$  upon each interval of which the oscillation of  $f(x)$  is less than  $\sigma$ .

Now to prove the condition sufficient we observe that if the content of  $[x_\sigma]$  is zero, there exists for every  $\lambda$  a partition  $\pi_\lambda$ , such that the sum of the lengths of the intervals containing points of  $[x_\sigma]$  is less than  $\lambda$ . Moreover we have just seen that the intervals which do not contain points on  $[x_\sigma]$  can be repartitioned into intervals on which the oscillation is less than  $\sigma$ . Hence, by Theorem 127, the function is integrable.

To prove the condition necessary we note that on every interval containing a point,  $x_\sigma$ , the oscillation of  $f(x)$  is greater than or equal to  $\sigma$ . Hence, if

$$C[x_\sigma] > 0,$$

the sum of the intervals upon which the oscillation is greater than or equal to  $\sigma$  is greater than  $C[x_\sigma]$ .

**Definition.**—A set of points is said to be numerable if it is capable of being set into one-to-one correspondence with the positive integral numbers. If a set  $[x]$  is numerable, it can always be indicated by the notation  $x_1, x_2, x_3, \dots, x_n, \dots$ , or  $\{x_n\}$ , but if it is not numerable, the notation  $\{x_n\}$  cannot be applied with the understanding that  $n$  is integral.

**Theorem 129.** *A perfect set of points is not numerably infinite.<sup>9</sup>*

**Proof.** Suppose the theorem not true. Then there exists a sequence of points  $\{x_n\}$  containing every point of a perfect set  $[x]$ . Let  $P_1$  be any point of  $[x]$ , and  $\overline{a_1 b_1}$  a segment containing  $P_1$ . Let  $x_{n_1}$  be the first of  $\{x_n\}$  within  $\overline{a_1 b_1}$ . Since  $x_n$  is a limit point of points of  $[x]$ , there are points of the set other than  $P_1$  and  $x_{n_1}$  on the segment  $\overline{a_1 b_1}$ . Let  $P_2$  be such a point, and let  $\overline{a_2 b_2}$  be a segment within  $\overline{a_1 b_1}$  and containing  $P_2$  but neither  $P_1$  nor  $x_{n_1}$ . Let  $x_{n_2}$  be the first point of  $\{x_n\}$  within  $\overline{a_2 b_2}$ . Proceeding in this manner we obtain a sequence of segments  $\{\overline{a_i b_i}\}$  such that every segment lies within the preceding and such that every segment  $\overline{a_i b_i}$  contains no point  $x_{n_{i-k}}$  of the sequence  $\{x_n\}$ . By the lemma on

<sup>7</sup>For further discussion of the notion *content* see PIERPONT, *Real Functions*, Vol. I, p. 352, and LEBESGUE, *Leçons sur l'Intégration*.

<sup>8</sup>Compare the example on page 124.

<sup>9</sup>For definition of perfect set see page 31.

page 31, Chapter II, there is a point  $P$  on every segment of this set. Since there are points of  $[x]$  on every segment  $\overline{a_i b_i}$ ,  $P$  is a limit point of the set  $[x]$ . Since  $[x]$  is a perfect set,  $P$  is a point of  $[x]$ . But if  $P$  were in the sequence  $\{x_n\}$ , there would be only a finite number of points of  $[x]$  preceding  $P$ , whereas by the construction there is an infinitude of such points.

**Theorem 130.** *A numerably infinite set of sets of points each of content zero cannot contain every point of any interval.*

**Proof.** Let the set of sets be ordered into a sequence  $\{[x]_n\}$ . We show that on every segment  $\overline{a b}$  there is at least one point not of  $\{[x]_n\}$ . Since  $[x]_1$  is of content zero, there is a segment  $\overline{a_1 b_1}$  contained in  $\overline{a b}$  which contains no point of  $[x]_1$ . Let  $[x]_{n_1}$  be the first set of the sequence which contains a point of  $\overline{a_1 b_1}$ . Since  $[x]_{n_1}$  is of content zero, there is a segment  $\overline{a_2 b_2}$  contained in  $\overline{a_1 b_1}$  which contains no point of  $[x]_{n_1}$ . Continuing in this manner we obtain a sequence of segments  $\overline{a b}, \overline{a_1 b_1}, \dots, \overline{a_n b_n} \dots$  such that every segment lies within the preceding, and such that  $\overline{a_n b_n}$  contains no point of  $[x]_1, \dots, [x]_n$ . By the lemma on page 31 there is at least one point  $P$  on all these segments. Hence  $P$  is a point of  $\overline{a b}$  and is not a point of any set of  $\{[x]_n\}$ .

**Theorem 131.** *The points of discontinuity of an integrable function form at most a set consisting of a numerable set of sets, each of content zero.*

**Proof.** Let  $\sigma_1, \sigma_2, \sigma_3, \dots$  be any set of numbers such that

$$\sigma_n > \sigma_{n+1},$$

and

$$\lim_{n \rightarrow \infty} \sigma_n = 0.$$

By Theorem 128 the set of points  $[x_{\sigma_n}]$  at which the oscillation of  $f(x)$  is greater than or equal to  $\sigma_{n+1}$  and less than  $\sigma_n$  is of content zero. Since the set of sets  $\{[x_{\sigma_n}]\}$  includes all the points of discontinuity of  $f(x)$ , this proves the theorem.

**Theorem 132.** *If a function  $f(x)$  is integrable on an interval  $\overline{a b}$ , then it is continuous at a set of points which is everywhere dense on  $\overline{a b}$ .*

**Proof.** If the theorem fails to hold, then there exists an interval  $\overline{a b}$  on which the function is discontinuous at every point. By Theorem 131 an integrable function is discontinuous at most on a numerably infinite set of sets each of content zero, and by Theorem 130 such sets of sets fail to contain every point of any interval.

**Theorem 133.** *If*

$$\int_a^X f(x) dx = 0$$

*for every  $X$  of  $\overline{a b}$ , then  $f(x) = 0$  on a set of points everywhere dense on  $\overline{a b}$ , and for every  $\sigma > 0$  the points where  $|f(x)| > \sigma$  form a set of content zero.*



**Proof.** At every point  $X$  where  $f(x)$  is continuous, according to the corollary of Theorem 119,

$$\frac{d}{dX} \int_a^X f(x)dx = f(X) = 0,$$

since  $\int_a^X f(x)dx$  is a constant. The points of continuity of  $f(x)$  are everywhere dense, according to Theorem 132. Hence the zero points of  $f(x)$  are everywhere dense. At a point of discontinuity the oscillation of  $f(x)$  is greater than or equal to  $|f(x)|$ . Hence the points where  $|f(x)| > \sigma$  form a set of content zero.

**Theorem 134.** *If*

$$\int_a^X f(x)dx = \int_a^X \phi(x)dx$$

for every  $X$  of  $a$   $\overline{b}$ , then  $f(x) = \phi(x)$  on a set of points everywhere dense on  $a$   $\overline{b}$ , and for every  $\sigma > 0$  the points where  $|f(x) - \phi(x)| > \sigma$  forms a set of content zero.

**Proof.** Apply the theorem above to  $f(x) - \phi(x)$ .

**Theorem 135.** *If  $f(x)$  is integrable from  $a$  to  $b$ , then  $|f(x)|$  is integrable from  $a$  to  $b$ .*<sup>10</sup>

**Proof.** Since

$$0 \leq O_\pi |f(x)| \leq O_\pi f(x),$$

it follows that  $\underline{B} O_\pi f(x) = 0$  implies  $\underline{B} O_\pi |f(x)| = 0$ , and hence the integrability of  $f(x)$  implies the integrability of  $|f(x)|$ .

**Theorem 136.** *If  $f(x)$  and  $\phi(x)$  are both integrable on an interval  $a$   $\overline{b}$ , then*

$$f(x) \cdot \phi(x) \tag{1}$$

is integrable on  $a$   $\overline{b}$ ; and, provided there is a constant  $m > 0$  such that  $|\phi(x)| - m > 0$  for  $x$  on  $a$   $\overline{b}$ , then

$$f(x) \div \phi(x) \tag{2}$$

is integrable on  $a$   $\overline{b}$ .

**Proof.** Since  $f(x)$  and  $\phi(x)$  are both integrable on  $a$   $\overline{b}$ , it follows that for every pair of positive numbers  $\sigma$  and  $\lambda$  there is a partition  $\pi_1$  for  $f(x)$  and a partition  $\pi_2$  for  $\phi(x)$  such that the sums of the lengths of the intervals on which the oscillations of  $f(x)$  and  $\phi(x)$  respectively are greater than  $\sigma$  are less than  $\lambda$ . Let  $\pi$  be the partition consisting of the points of both  $\pi_1$  and  $\pi_2$ . Then the sum of the intervals of  $\pi$  on which the oscillation of

<sup>10</sup>The converse theorem is not true; cf. example given on page 154.

either  $f(x)$  or  $\phi(x)$  is greater than  $\sigma$  is less than  $2\lambda$ . Let  $M$  be the greater of  $\overline{B}|f(x)|$  and  $\overline{B}|\phi(x)|$  on  $a b$ . Then on any interval of  $\pi$  on which the oscillations of  $f(x)$  and  $\phi(x)$  are both less than  $\sigma$  the oscillation of  $f(x) \cdot \phi(x)$  is less than  $\sigma M$ . Hence the sum of the intervals on which the oscillation of  $f(x) \cdot \phi(x)$  is greater than  $\sigma M$  is less than  $2\lambda$ . Since  $\sigma$  and  $\lambda$  may be chosen so that  $2\lambda$  and  $\sigma M$  shall be any pair of preassigned numbers, it follows by Theorem 127 that  $f(x) \cdot \phi(x)$  is integrable on  $a b$ .

In view of the argument above it is sufficient for the second theorem to prove that  $\frac{1}{\phi(x)}$  is integrable on  $a b$  if  $\phi(x)$  is integrable and  $|\phi(x)| > m$ . Consider a partition  $\pi$  such that the sum of the intervals on which the oscillation of  $\phi(x)$  is greater than  $\sigma$  is less than  $\lambda$ . Since

$$\left| \frac{1}{\phi(x_1)} - \frac{1}{\phi(x_2)} \right| = \frac{|\phi(x_1) - \phi(x_2)|}{|\phi(x_1)| \cdot |\phi(x_2)|},$$

it follows that  $\pi$  is such that the sum of the intervals on which the oscillation of  $\frac{1}{\phi(x)}$  is greater than  $\frac{\sigma}{m^2}$  is less than  $\lambda$ , and  $\frac{1}{\phi(x)}$  is integrable according to Theorem 127.

A second proof may be made by comparing the integral oscillations of  $f(x)$  and  $\phi(x)$  with those of the functions (1) and (2) and applying Theorem 125.<sup>11</sup>

**Theorem 137.** If  $f(x)$  is an integrable function on an interval  $a b$ , and if  $\phi(y)$  is a continuous function on an interval  $\underline{B}f \overline{B}f$ , where  $\underline{B}f$  and  $\overline{B}f$  are the lower and upper bounds respectively of  $f(x)$  on  $a b$ , then  $\phi\{f(x)\}$  is an integrable function of  $x$  on the interval  $a b$ .<sup>12</sup>

**Proof.** By Theorem 48 there exists for every  $\sigma > 0$  a  $\delta_\sigma$  such that for  $|y_1 - y_2| < \delta_\sigma$ ,

$$|\phi(y_1) - \phi(y_2)| < \sigma. \quad (1)$$

Since  $f(x)$  is integrable on  $a b$  it follows by Theorem 127 that for every positive number  $\lambda$  there is a partition  $\pi$  such that the sum of the intervals on which the oscillation of  $f(x)$  is greater than  $\delta_\sigma$  is less than  $\lambda$ . But by (1) this means that the sum of the intervals on which the oscillation of  $\phi\{f(x)\}$  is greater than  $\sigma$  is less than  $\lambda$ . This, by Theorem 127, proves that  $\phi\{f(x)\}$  is integrable.

<sup>11</sup>Cf. PIERPONT, Vol. I, pp. 346, 347, 348.

<sup>12</sup>This theorem is due to DU BOIS REYMOND. It cannot be modified so as to read "an integrable function of an integrable function is integrable." Cf. E. H. MOORE, *Annals of Mathematics*, new series, Vol. 2, 1901, p. 153.

# Chapter 9

## IMPROPER DEFINITE INTEGRALS.

### § 1 The Improper Definite Integral on a Finite Interval.

If  $f(x)$  is infinite at one or more points of the interval  $a b$ , then, whatever may be the other properties of the function, the definite integral of  $f(x)$  defined in Chapter VIII cannot exist on the interval  $a b$ .

**Definition.**—If  $\int_x^b f(x)dx$  exists for every  $x$ ,  $a < x < b$ , and if<sup>1</sup>

$$\lim_{x \rightarrow a} \int_x^b f(x)dx$$

exists and is finite,  $f(x)$  being unbounded on every neighborhood of  $x = a$ , then this limit is the *improper definite integral* on the interval  $a b$ . If  $f(x)$  is unbounded in every neighborhood of  $x = a$ , and also in every neighborhood of  $x = b$ , but bounded on some neighborhood of every other point of the interval  $a b$ , we consider two intervals  $a c$  and  $c b$  where  $c$  is any point  $a < c < b$ . If the improper definite integral exists on  $a c$  and also on  $c b$ , then the sum of these integrals is the improper definite integral on  $a b$ .

---

<sup>1</sup>We will understand throughout this chapter that in the expression

$$\lim_{x \rightarrow a} \int_x^b f(x)dx$$

$x$  approaches  $a$  on the interval  $a b$ .

This definition can obviously be extended to the case where the function is unbounded in the neighborhood of a finite number of points. Such points are then considered as partition points, dividing the interval  $\overline{a b}$  into a set of subintervals. If the improper definite integral exists on each of these intervals, their sum is the improper definite integral on  $\overline{a b}$ .

**Theorem 138.** *If  $\int_x^b f(x)dx$  exists for every  $x$ ,  $a < x < b$ , then a necessary and sufficient condition that*

$$L_{x \doteq a} \int_x^b f(x)dx$$

*shall exist and be finite is that for every  $\varepsilon$  there exists a  $V_\varepsilon^*(a)$  such that for every two values of  $x$ ,  $x_1$  and  $x_2$ , on the interval  $\overline{a b}$  and on  $V_\varepsilon^*(a)$*

$$\left| \int_{x_1}^{x_2} f(x)dx \right| < \varepsilon.$$

**Proof.** This theorem is a special case of Theorem 27, since, by Theorem 110,

$$\int_{x_1}^{x_2} f(x)dx = \int_{x_1}^b f(x)dx - \int_{x_2}^b f(x)dx.$$

**Theorem 139.** *If  $\int_x^b f(x)dx$  exists for every  $x$ ,  $a < x < b$ , and if*

$$L_{x \doteq a} \int_x^b |f(x)| dx$$

*is finite, then*

$$L_{x \doteq a} \int_x^b f(x)dx$$

*exists and is finite.*<sup>2</sup>

**Proof.** By the necessary condition of Theorem 138 there is a  $V_\varepsilon^*(a)$  corresponding to any preassigned  $\varepsilon$  such that for any two values of  $x$ ,  $x_1$  and  $x_2$ , which lie on the segment  $\overline{a b}$  and on  $V_\varepsilon^*(a)$

$$\left| \int_{x_1}^{x_2} |f(x)| dx \right| < \varepsilon.$$

---

<sup>2</sup>The first part of the hypothesis in this theorem is not redundant, as is shown by the following example. Let  $f(x) = x^{-\frac{1}{2}}$  for positive rational values of  $x$  and  $f(x) = -x^{-\frac{1}{2}}$  for positive irrational values of  $x$ . In this case  $L_{x \doteq 0} \int_x^b |f(x)|dx$  exists and is finite, while  $\int_x^b f(x)dx$  does not exist for any value of  $x$  on the interval  $a b$ , and consequently  $L_{x \doteq a} \int_x^b f(x)dx$  has no meaning since the limitand does not exist.

But, by Theorem 107,

$$\left| \int_{x_1}^{x_2} |f(x)| dx \right| \geq \left| \int_{x_1}^{x_2} f(x) dx \right|,$$

since, by the hypothesis and Theorem 105,  $\int_{x_1}^{x_2} f(x) dx$  exists. Hence, by the sufficient condition of Theorem 138,

$$L_{x \doteq a} \int_x^b f(x) dx$$

exists and is finite.

**Theorem 140.** *If  $\int_x^b f(x) dx$  exists for every  $x$  on the segment  $\overline{ab}$ , and if  $(x - a)^k f(x)$  is bounded on  $V^*(a)$  for some value of  $k$ ,  $0 < k < 1$ , then*

$$L_{x \doteq a} \int_x^b f(x) dx$$

*exists and is finite.*

**Proof.** By hypothesis  $(x - a)^k |f(x)| \leq M$ , i.e.,

$$|f(x)| \leq \frac{M}{(x - a)^k},$$

where  $M$  may be taken greater than one. The proof of the theorem consists in showing that for every  $\varepsilon$  there exists a  $\delta_\varepsilon$  such that if  $0 < x_1 - a < \delta_\varepsilon$ ,  $0 < x_2 - a < \delta_\varepsilon$ ,  $x_1 < x_2$ , then

$$\left| \int_{x_1}^{x_2} f(x) dx \right| < \varepsilon.$$

By Theorems 105 and 113,

$$\begin{aligned} \left| \int_{x_1}^{x_2} f(x) dx \right| &\leq \int_{x_1}^{x_2} |f(x)| dx \leq \int_{x_1}^{x_2} \frac{M}{(x - a)^k} dx \\ &= \frac{M}{1 - k} \left\{ (x_2 - a)^{1-k} - (x_1 - a)^{1-k} \right\}. \end{aligned}$$

That the last term of this series of inequalities is infinitesimal, the reader may verify by choosing

$$\delta_\varepsilon = \left( \frac{\varepsilon(1 - k)}{M} \right)^{\frac{1}{1-k}}.$$

This theorem may also be proved as a corollary of Theorem 143.

*Corollary.*—If  $f(x)$  is integrable on  $x$   $\overline{b}$  for every  $x$  of  $a$   $\overline{b}$ , and is of the same or lower order than  $\frac{1}{(x-a)^k}$  for some value of  $k$ ,  $0 < k < 1$ , then

$$L_{x \doteq a} \int_x^b f(x) dx$$

exists and is finite.

**Theorem 141.** *If for any positive number  $m$  and for any  $k \geq 1$  there exists a  $V^*(a)$  on which  $f(x)$  does not change sign, and on which  $(x-a)^k f(x) > m$  for every  $x$ , then*

$$L_{x \doteq a} \int_x^b f(x) dx$$

cannot exist and be finite.

**Proof.** (1) In case

$$\int_x^b f(x) dx$$

fails to exist for some value of  $x$  between  $a$  and  $b$ ,

$$L_{x \doteq a} \int_x^b f(x) dx$$

fails to exist because the limitand function does not exist.

(2) If

$$\int_x^b f(x) dx$$

exists for every value of  $x$  between  $a$  and  $b$ , we proceed as follows: Let  $\delta < 1$  be the length of a  $V^*(a)$  on which  $f(x)$  does not change sign, and on which  $(x-a)^k f(x) > m$ , and let  $x_2$  be the extremity of this neighborhood, which is greater than  $a$ . Then  $|f(x)| > \frac{m}{(x-a)^k} > \frac{m}{(x_2-a)^k}$  for every  $x$  on this neighborhood. Take  $x_1$  so that  $(x_2-a)^k = 2(x_2-x_1)$ . Then

$$\left| \int_{x_1}^{x_2} f(x) dx \right| > \frac{m}{(x_2-a)^k} (x_2-x_1) = \frac{1}{2}m.$$

Hence, by the necessary condition of Theorem 138,

$$L_{x \doteq a} \int_x^b f(x) dx$$

cannot exist and be finite.

**Theorem 142.** *If*

$$L_{x \doteq a} \int_x^b f(x) dx$$

*exists and is finite and if  $f(x)$  approaches infinity monotonically as  $x \doteq a$  on some  $V^*(a)$ , then*

$$L_{x \doteq a} (x - a) \cdot f(x) = 0,$$

*or in other words  $f(x)$  has an infinity of order lower than  $\frac{1}{x-a}$ .*<sup>3</sup>

**Proof.** By means of Theorem 138 it follows from the hypothesis that for every  $\varepsilon$  there exists a  $V_\varepsilon^*(a)$  within  $V^*(a)$  such that for every  $x_1$  and  $x_2$  on  $\overline{a b}$ , and also on  $V_\varepsilon^*(a)$ ,

$$\left| \int_{x_1}^{x_2} f(x) dx \right| < \varepsilon.$$

Let  $x_2$  be any point of such a neighborhood and let  $x_1$  be so chosen that

$$x_1 - a = x_2 - x_1.$$

Since  $x_1$  and  $x_2$  are on  $V^*(a)$ ,

$$f(x_1) > f(x_2).$$

It follows from Theorem 116 that

$$\left| \int_{x_1}^{x_2} f(x) dx \right| > |f(x_2)| \cdot (x_2 - x_1).$$

But

$$f(x_2) \cdot (x_2 - x_1) = \frac{1}{2} f(x_2) \cdot (x_2 - a).$$

Hence for  $x = x_2$ ,

$$|f(x)| \cdot (x - a) < 2\varepsilon.$$

---

<sup>3</sup>  $L_{x \doteq a} (x - a) \cdot f(x) = 0$  is not a sufficient condition for the existence of

$$L_{x \doteq a} \int_x^b f(x) dx,$$

as is shown by the following example. Consider a set of points  $x_1, x_2, x_3, \dots, x_n, \dots$  such that  $x_n - a = 2(x_{n+1} - a)$ ,  $x_1 - a$  being unity. Define  $f(x_1) = 1, f(x_2) = \frac{4}{3}, f(x_3) = 2, \dots, f(x_n) = \frac{2^n}{n+1}, \dots$ . Let the function be linear from  $f(x_1)$  to  $f(x_2)$ , from  $f(x_2)$  to  $f(x_3)$ , etc. Then

$$\left| \int_{x_1}^{x_2} f(x) dx \right| > \frac{1}{2}, \quad \left| \int_{x_2}^{x_3} f(x) dx \right| > \frac{1}{3}, \text{ etc.}$$

Since these integrals are all of the same sign, their sum for any given number of terms is greater than the sum of the corresponding number of terms in the harmonic series. Also  $(x_n - a) \cdot f(x_n) = \frac{2}{n+1}$ , whence

$$L_{x \doteq a} (x - a) \cdot f(x) = 0.$$

Since  $\varepsilon$  is arbitrary, and since  $x_2$  is any point in  $V^*(a)$ , it follows that

$$\lim_{x \rightarrow a} f(x) \cdot (x - a) = 0.$$

*Corollary.*—If

$$\int_x^b f(x) dx$$

exists for every  $x$  between  $a$  and  $b$ , and

$$\lim_{x \rightarrow a} \int_x^b f(x) dx$$

exists and is finite, and if  $f(x)$  is entirely positive or entirely negative, then zero is a value approached by  $(x - a) \cdot f(x)$  as  $x$  approaches  $a$ .

**Proof.** Consider the case when the function is entirely positive. Suppose zero is not a value approached. Then there exists a pair of positive numbers  $\varepsilon$  and  $\delta$  such that for every  $x$ ,  $x - a < \delta$ ,

$$(x - a) \cdot f(x) > \varepsilon.$$

On the interval,  $\overbrace{a \quad a + \delta}$ , consider the function

$$\frac{\varepsilon}{x - a}.$$

Since

$$\int_x^b \frac{\varepsilon}{x - a} dx$$

is a non-oscillating function of  $x$ , it follows from Theorem 25 that

$$\lim_{x \rightarrow a} \int_x^b \frac{\varepsilon}{x - a} dx$$

exists, and by Theorem 142 this limit must be infinite. Since

$$|f(x)| > \frac{\varepsilon}{x - a}$$

on the neighborhood under consideration, it follows from Theorem 107 and Corollary 2; Theorem 40, that

$$\lim_{x \rightarrow a} \int_x^b f(x) dx$$

exists and is infinite, which is contrary to the hypothesis.



**Theorem 143<sup>4</sup>.** *If*

- (1)  $f_1(x)$  and  $f_2(x)$  are of the same rank of infinity at  $x = a$ , or if  $f_1(x)$  is of lower order than  $f_2(x)$ ,
- (2)  $\int_x^b f_1(x)dx$  and  $\int_x^b f_2(x)dx$  both exist for every  $x$  on the segment  $\overline{ab}$ ,
- (3) There is a neighborhood of  $x = a$  on which  $f_2(x)$  does not change sign,
- (4)  $L_{x \dot{=} a} \int_a^b f_2(x)dx$  is finite,<sup>5</sup>

then it follows that  $L_{x \dot{=} a} \int_x^b f_1(x)dx$  exists and is finite.

**Proof.** Since from the hypothesis

$$L_{x \dot{=} a} \int_x^b f_2(x)dx$$

exists and is finite, we have by Theorem 138 that for every  $\varepsilon$  there exists a  $V_\varepsilon^*(a)$  such that for every  $x_1$  and  $x_2$  on segment  $\overline{ab}$  and on  $V_\varepsilon^*(a)$

$$\left| \int_{x_1}^{x_2} f_2(x)dx \right| < \varepsilon.$$

Consider  $x_1$  and  $x_2$  on a neighborhood of  $x = a$  for which  $\left| \frac{f_1(x)}{f_2(x)} \right| < M$  and for which  $f_2(x)$  does not change sign. Then, by Theorem 113,

$$\left| \int_{x_1}^{x_2} f_1(x)dx \right| < M \cdot \left| \int_{x_1}^{x_2} f_2(x)dx \right| < M \cdot \varepsilon.$$

Since  $M \cdot \varepsilon$  can be made small at will by making  $\varepsilon$  small, it follows by Theorem 138 that

$$L_{x \dot{=} a} \int_x^b f_1(x)dx$$

exists and is finite.

---

<sup>4</sup>This is what Professor MOORE in his lectures calls the relative convergence theorem. Theorems 143, 144, 151, 152 in this form are due to him.

<sup>5</sup>We notice that since under the hypothesis  $f_2(x)$  does not change sign,

$$L \int_x^b f_2(x)dx$$

cannot fail to exist either finite or infinite, for it follows from this hypothesis that  $\int_x^b f_2(x)dx$  is a non-oscillating function of  $x$  and therefore, by Theorem 25 that the limit exists.

An important special case of this theorem is when  $f_1(x)$  is of the same or lower order of infinity than  $f_2(x)$ , i.e.,  $L \frac{f_1(x)}{f_2(x)} = K$ , a constant not zero.

The reader should verify for himself that Theorem 140 is a corollary of Theorem 143. The other previous tests for the existence of the improper definite integral can all be reduced to special cases of Theorem 143. Cf., for example, the logarithmic test on page 410 of PIERPONT.

**Theorem 144.** *If*

(1)  $f_1(x)$  and  $f_2(x)$  are of the same rank of infinity at  $x = a$ , or if  $f_1(x)$  is of higher order than  $f_2(x)$ ,

(2)  $\int_x^b f_1(x)dx$  and  $\int_x^b f_2(x)dx$  both exist for every  $x$  on the segment  $\overline{ab}$ ,

(3) There is a neighborhood of  $x = a$  on which  $f_1(x)$  does not change sign,

(4)  $L \int_{x \doteq a}^b f_2(x)dx$  is infinite (see note under Theorem 143),

then  $L \int_{x \doteq a}^b f_1(x)dx$  exists and is infinite or fails to exist.<sup>6</sup>

**Proof.** This is a direct consequence of Theorem 143, since if

$$L \int_{x \doteq a}^b f_1(x)dx,$$

which exists by the foot-note of Theorem 143, were finite, then

$$L \int_{x \doteq a}^b f_2(x)dx$$

would exist and be finite.

**Theorem 145.** *If for a function  $f_1(x)$  which does not change sign in the neighborhood of  $x = a$  there exists a monotonic function  $f_2(x)$  infinite of the same rank as  $f_1(x)$  as  $x$*

*approaches  $a$ ,  $\int_x^b f_1(x)dx$  and  $\int_x^b f_2(x)dx$  both existing for every  $x$  on the segment  $\overline{ab}$ ,*

*then a necessary condition that  $L \int_{x \doteq a}^b f_1(x)dx$  shall exist and be finite is that*

$$L \int_{x \doteq a} (x - a) \cdot f_1(x) = 0.$$

<sup>6</sup>This is what Professor MOORE calls the relative divergence theorem.

**Proof.** By hypothesis

$$L_{x \dot{=} a} \int_x^b f_1(x) dx$$

exists and is finite. Hence, by Theorem 143,

$$L_{x \dot{=} a} \int_x^b f_2(x) dx$$

exists and is finite. Therefore, by Theorem 142,

$$L_{x \dot{=} a} (x - a) \cdot f_2(x) = 0.$$

Since  $\left| \frac{f_1(x)}{f_2(x)} \right|$  is bounded as  $x$  approaches  $a$ , i.e.,  $|f_1(x)| < M \cdot |f_2(x)|$ , we have

$$(x - a) \cdot |f_1(x)| < M \cdot (x - a) \cdot |f_2(x)|.$$

But

$$L_{x \dot{=} a} M \cdot (x - a) \cdot |f_2(x)| = 0.$$

Therefore, by Corollary 4, Theorem 40,

$$L_{x \dot{=} a} (x - a) \cdot |f_1(x)| = 0,$$

or by Corollary 2, Theorem 27,

$$L_{x \dot{=} a} (x - a) \cdot f_1(x) = 0.$$

## § 2 The Definite Integral on an Infinite Interval.

The integral over an infinite interval, viz.,

$$L_{x \dot{=} \infty} \int_a^x f(x) dx,$$

has properties analogous to those of the improper definite integral on a finite interval discussed in the preceding section, and is likewise called an improper definite integral.

The following theorems correspond to Theorems 138 to 145.

**Theorem 146.** *If*

$$\int_a^x f(x) dx$$

exists for every  $x$ ,  $a < x$ , then a necessary and sufficient condition that

$$L_{x \doteq \infty} \int_a^x f(x) dx$$

exists and is finite, is that for every  $\varepsilon$  there exists a  $D_\varepsilon$ , such that for every two values of  $x$ ,  $x_1$  and  $x_2$ , each greater than  $D_\varepsilon$ ,

$$\left| \int_{x_1}^{x_2} f(x) dx \right| < \varepsilon.$$

**Proof.** The theorem is a direct consequence of Theorems 105 and 27.

**Theorem 147.** If

$$\int_a^x f(x) dx$$

exists for every  $x$  greater than  $a$ , and if

$$L_{x \doteq \infty} \int_a^x |f(x)| dx$$

is finite,<sup>7</sup> then

$$L_{x \doteq \infty} \int_a^x f(x) dx$$

exists and is finite.

**Proof.** The proof is like that of Theorem 139.

**Theorem 148.** If

$$\int_a^x f(x) dx$$

exists for every  $x$  greater than  $a$ , and if  $(x - a)^k \cdot f(x)$  is bounded as  $x$  approaches infinity for some  $k$ ,  $k > 1$ , then

$$L_{x \doteq \infty} \int_a^x f(x) dx$$

exists and is finite.

**Proof.** If in the proof of Theorem 140 we write  $D_\varepsilon^{1-k} = \frac{\varepsilon(1-k)}{M}$  instead of  $\delta_\varepsilon^{1-k} = \frac{\varepsilon(1-k)}{M}$ , and use Theorem 146 instead of 138, the proof of Theorem 140 will apply to Theorem 148.

**Theorem 149.** If  $f(x)$  does not change sign for  $x$  greater than some fixed number  $D$ , and if for some positive number  $m$  and some number  $k \leq 1$ ,  $|(x - a)^k \cdot f(x)| > m$  for every  $x$  greater than  $D$ , then

$$L_{x \doteq \infty} \int_a^x f(x) dx$$

cannot exist and be finite.

---

<sup>7</sup>Note on page 154 shows that this hypothesis is not redundant.

**Proof.** By making suitable changes in the proof of Theorem 141 so as to make  $x_1$  and  $x_2$  approach infinity instead of  $a$ , that proof applies to this theorem.

**Theorem 150.** *If*

$$L_{x \doteq \infty} \int_a^x f(x) dx$$

*exists and is finite, and if  $f(x)$  is monotonic for all values of  $x$  greater than some fixed number, then*

$$L_{x \doteq \infty} (x - a) \cdot f(x) = 0.$$

**Proof.** By making slight modifications of the proof of Theorem 142, that proof applies to this theorem.

*Corollary.*—If

$$\int_a^x f(x) dx$$

exists for every  $x$  greater than  $a$ , and

$$L_{x \doteq \infty} \int_a^x f(x) dx$$

exists and is finite, and if  $f(x)$  does not change sign for  $x$  greater than some fixed number, then zero is a value approached by  $(x - a)f(x)$  as  $x$  approaches  $\infty$ .

The proof is similar to that of the corollary of Theorem 142.

**Theorem 151.** *If*

- (1)  $f_1(x)$  and  $f_2(x)$  are infinitesimals of the same rank as  $x$  approaches  $\infty$ , or if  $f_1(x)$  is of higher order than  $f_2(x)$ ,
- (2)  $\int_a^x f_1(x) dx$  and  $\int_a^x f_2(x) dx$  both exist for every  $x$ ,  $a < x$ ,
- (3)  $f_2(x)$  does not change sign for  $x$  greater than some fixed number,
- (4)  $L_{x \doteq \infty} \int_a^x f_2(x) dx$  is finite,

then it follows that

$$L_{x \doteq \infty} \int_a^x f_1(x) dx$$

exists and is finite.<sup>8</sup>

**Proof.** The proof is analogous to that of Theorem 143.

---

<sup>8</sup>See note under Theorem 143.

**Theorem 152.** *If*

- (1)  $f_1(x)$  and  $f_2(x)$  are infinitesimals of the same rank as  $x$  approaches infinity, or if  $f_1(x)$  is of lower order than  $f_2(x)$ ,
- (2)  $\int_a^x f_1(x)dx$  and  $\int_a^x f_2(x)dx$  both exist for every  $x, a < x$ ,
- (3)  $f_1(x)$  does not change sign for  $x$  greater than some fixed number,
- (4)  $L_{x \rightarrow \infty} \int_a^x f_2(x)dx$  is infinite,

then

$$L_{x \rightarrow \infty} \int_a^x f_1(x)dx$$

exists and is infinite or fails to exist.

Proof like that of Theorem 144.

**Theorem 153.** *If for a function  $f_1(x)$  which does not change sign in the neighborhood of  $x = \infty$  there exists a monotonic function  $f_2(x)$  such that  $f_1(x)$  and  $f_2(x)$  are infinitesimals of the same rank as  $x$  approaches infinity,  $\int_a^x f_1(x)dx$  and  $\int_a^x f_2(x)dx$  both existing for every  $x > a$ , then a necessary condition that*

$$L_{x \rightarrow \infty} \int_a^x f_1(x)dx$$

shall exist and be finite is that

$$L_{x \rightarrow \infty} (x - a) \cdot f_1(x) = 0.$$

The proof is like that of Theorem 145.

### § 3 Properties of the Simple Improper Definite Integral.

The following definition of the simple improper definite integral is equivalent in substance to that given on page 153, and in form is partly the definition of the general improper definite integral given on page 168.

The definite integral of a function is said to *exist properly at a point  $x_1$*  or in the neighborhood of this point, on the interval  $a b$  if there exists an interval  $a_1 b_1$  containing  $x_1$  as an interior point (or as an end point in case  $x_1 = a$  or  $x_1 = b$ ) such that the proper definite integral of  $f(x)$  exists on this interval. The integral is said to exist improperly at

a point  $x_1$  on the interval  $a b$  if  $f(x)$  has an infinite singularity at  $x_1$  and there exists an interval  $a_1 b_1$  on  $a b$  containing  $x_1$  as an interior point (or end point in case  $x_1 = a$  or  $x_1 = b$ ) such that the improper definite integral exists on each of the intervals  $a_1 x_1$  and  $x_1 b_1$ .

If on an interval  $a b$  the definite integral exists properly at every point except a finite number of points, and exists improperly at each of these points, then the improper definite integral is said to exist simply on the interval  $a b$ , or the simple improper definite integral is said to exist on the interval  $a b$ . Let  $x_1, x_2, \dots, x_n$  be the points of  $a b$  at which the integral exists improperly. The *simple improper definite integral* on  $a b$  is the sum of the improper definite integrals on the intervals  $a x_1, x_1 x_2, \dots, x_{n-1} x_n, x_n b$ .

We denote the simple improper definite integral of  $f(x)$  on the interval  $a b$  by

$$S \int_a^b f(x) dx.$$

This symbol is used generically to include the proper as well as the improper definite integral.

**Theorem 154.** *If  $a < b < c$ , and if two of the three simple improper definite integrals*

$$S \int_a^b f(x) dx, \quad S \int_b^c f(x) dx, \quad \text{and} \quad S \int_a^c f(x) dx$$

*exist, then the third exists and*

$$S \int_a^b f(x) dx + S \int_b^c f(x) dx = S \int_a^c f(x) dx.$$

**Proof.** If  $b$  is a point at which the integral exists improperly, and if

$$S \int_a^b f(x) dx \quad \text{and} \quad S \int_b^c f(x) dx$$

both exist, then by the definition of

$$S \int_a^c f(x) dx$$

the latter exists and is equal to the sum of the two former.

If one of the two integrals, say

$$S \int_a^b f(x) dx,$$

exists, and if

$$\int_a^c f(x)dx$$

exists, then

$$\int_b^c f(x)dx$$

exists since only in that case does

$$\int_a^c f(x)dx$$

exist. The equation

$$\int_a^b f(x)dx + \int_b^c f(x)dx = \int_a^c f(x)dx$$

likewise holds.

If  $b$  is a point at which the integral exists *properly*, then the theorem follows from the above argument and the definition on page 164.

**Theorem 155.** *If*

$$\int_a^b f(x)dx$$

*exists, then*

$$\int_b^a f(x)dx$$

*exists and*

$$\int_a^b f(x)dx = - \int_b^a f(x)dx.$$

**Proof.** In case the integral exists improperly only at one point of the interval, then the theorem is an immediate consequence of Theorem 108 and Corollary 1, Theorem 27. (If  $\int_a^b f(x) = K$ , then  $\int_a^b \{-f(x)\} = -K$ .) The theorem in the general case follows directly from this case and the definition of the simple improper definite integral.

**Theorem 156.** *If  $c$  is a constant and if the simple improper definite integral of  $f(x)$  exists on  $a$   $b$ , then the simple improper definite integral of  $c \cdot f(x)$  exists on  $a$   $b$  and*

$$c \int_a^b f(x)dx = \int_a^b cf(x)dx.$$

**Proof.** The theorem is a direct consequence of Theorems 111 and 34.



**Theorem 157.** *If the simple improper definite integrals of  $f_1(x)$  and  $f_2(x)$  both exist on  $\overline{[a, b]}$ , then the simple improper definite integral of  $f_1(x) + f_2(x)$  and of  $f_1(x) - f_2(x)$  both exist and*

$$\int_a^b \{f_1(x) \pm f_2(x)\} dx = \int_a^b f_1(x) dx \pm \int_a^b f_2(x) dx.$$

**Proof.** The theorem is a direct consequence of Theorems 112 and 34.

**Theorem 158.** *If the simple improper definite integrals of  $f_1(x)$  and  $f_2(x)$  both exist, and if  $f_1(x) \geq f_2(x)$ , then*

$$\int_a^b f_1(x) dx \geq \int_a^b f_2(x) dx.$$

**Proof.** The theorem is a direct consequence of Theorem 113 and Corollary 2, Theorem 40.

**Theorem 159.** *If*

$$\int_a^b f(x) dx$$

*exists, then*

$$\int_a^x f(x) dx$$

*is a continuous function of the limit of integration on the interval  $\overline{[a, b]}$ .*

**Proof.** If  $x$  is a point at which the integral exists properly, the theorem is the same as 118. If  $x$  is a point at which the integral exists improperly, then the theorem follows from Theorems 138 and 27.

**Theorem 160.** *If*

$$\int_a^b f(x) dx$$

*exists, it does not follow that*

$$\int_a^b |f(x)| dx$$

*exists.*

**Proof.** Let

$$x_1, x_2, x_3, \dots, x_n, \dots$$

be an infinite sequence of points on  $\overline{[0, 1]}$  in the order indicated from 1 towards 0 such that

$$\int_{x_n}^{x_{n-1}} \frac{dx}{x} = \frac{1}{n}.$$

Consider a function  $f(x)$  defined as follows:

$$f(x) = \frac{1}{x} \quad \text{on } \overline{x_1 \ 1}, \overline{x_3 \ x_2}, \text{ etc.}$$

$$f(x) = -\frac{1}{x} \quad \text{on } \overline{x_2 \ x_1}, \overline{x_4 \ x_3}, \text{ etc.}$$

Obviously

$$L_{x \neq 0} \int_x^1 f(x) dx^9$$

exists and is finite since the series  $\frac{1}{2} - \frac{1}{3} + \frac{1}{4} \dots$  is convergent, while

$$L_{x \neq 0} \int_x^1 |f(x)| dx$$

is divergent since the harmonic series is divergent.

## § 4 A More General Improper Integral.

The problem of defining and studying the properties of the improper integral when the set of points of singularity is infinite has been treated by many writers.<sup>10</sup> In this section we give a few properties of improper integrals as defined by HARNACK and MOORE.

Denote by  $P_0$  any set of points of content zero on  $\overline{a \ b}$ , and by  $P$  the set of all points of  $\overline{a \ b}$  not points of  $P_0$ .  $P$  and  $P_0$  are complementary subsets of  $\overline{a \ b}$ . Denote by  $I$  any finite set of non-overlapping intervals of  $\overline{a \ b}$  which contain no point of the set  $P_0$ . The symbol  $m(I)$  stands for the sum of the lengths of the intervals of  $I$ . For the sake of brevity  $D$  will be used for  $|a - b|$ .

The following conditions are assumed to be satisfied:

<sup>9</sup>That 0 is a limit point of the sequence of points is obvious since in case this sequence has a limit point greater than zero the proper definite integral of the function  $\frac{1}{x}$  would fail to exist on some interval  $\overline{a \ b}$  where  $0 < a < b$ , which is impossible.

<sup>10</sup>A. CAUCHY and B. RIEMANN studied the case of a finite number of singularities in papers which are to be found in these writers' collected works. The infinite case has been treated by

A. HARNACK, *Mathematische Annalen*, Vols. 21 and 24 (1883–84).

O. HÖLDER, *Mathematische Annalen*, Vol. 24 (1884).

C. JORDAN, *Cours d'Analyse*, Vol. 2 (1894, 2d ed.).

O. STOLZ, *Grundzüge der Differential- und Integralrechnung*, Vol. 3.

A. SCHOENFLIES, *Jahresbericht der Deutschen Mathematiker-Vereinigung*, Vol. 8 (1900).

VALLÉE-POUSSIN, *Liouville's Journal*, Ser. 4, Vol. 8 (1892).

E. H. MOORE, *Transactions of the American Mathematical Society*, Vol. 2 (1901).

J. PIERPONT, *Theory of Functions of Real Variables* (1906).

(a) The definite integral of  $f(x)$  exists properly at every point of  $P$ . The sum of the integrals of  $f(x)$  on the intervals of  $I$  is denoted by

$$\int_{a I}^b f(x)dx.$$

(b) For every positive  $\varepsilon$  there exists a positive  $\delta_\varepsilon$  such that for any two sets,  $I'$  and  $I''$ , of intervals none of which contain any point of  $P_0$  and for which

$$|D - m(I')| < \delta_\varepsilon \quad \text{and} \quad |D - m(I'')| < \delta_\varepsilon,$$

$$\left| \int_{a I'}^b f(x)dx - \int_{a I''}^b f(x)dx \right| < \varepsilon.$$

It follows by Theorem 27 that

$$\lim_{m(I) \rightarrow D} \int_{a I}^b f(x)dx$$

exists and is finite. This limit is denoted by

$$\int_{a P_0}^b f(x)dx$$

and is called the *broad improper definite integral* with respect to  $P_0$  of the function  $f(x)$  on the interval  $\overline{a b}$ .

It is to be noticed that all the points of  $P_0$  need not be on  $\overline{a b}$ ; those which are not on  $\overline{a b}$  do not affect the existence of

$$\int_{a P_0}^b f(x)dx.$$

Therefore if  $f(x)$  is improperly integrable on some sub-interval  $\overline{a' b'}$  of  $\overline{a b}$ , its integral may be denoted by

$$\int_{a' P_0}^{b'} f(x)dx.$$

**Theorem 161.** *If  $a < b < c$  and if of the integrals*

$$\int_{a P_0}^b f(x)dx, \quad \int_{b P_0}^c f(x)dx, \quad \int_{a P_0}^c f(x)dx,$$

*either*

$$(a) \quad \int_{a P_0}^b f(x)dx \quad \text{and} \quad \int_{b P_0}^c f(x)dx \quad \text{exist, or}$$

$$(b) \quad \int_{b \int_a P_0}^c f(x) dx \text{ exists,}$$

then all three integrals exist and

$$\int_{b \int_a P_0}^b f(x) dx + \int_{b \int_b P_0}^c f(x) dx = \int_{b \int_a P_0}^c f(x) dx. \quad (1)$$

**Proof.** Every set  $I$  of intervals on  $\overline{a c}$  may be regarded as composed of a set  $\bar{I}$  on  $\overline{a b}$  and a set  $\bar{\bar{I}}$  on  $\overline{b c}$ , while, conversely, every pair of sets  $\bar{I}$  and  $\bar{\bar{I}}$  constitute a set  $I$ . Hence

$$\int_{a I}^c f(x) dx = \int_{a \bar{I}}^b f(x) dx + \int_{b \bar{\bar{I}}}^c f(x) dx.$$

(Note that both members of this equation are multiple-valued functions of  $m(I)$  and of  $m(\bar{I})$  and  $m(\bar{\bar{I}})$ ). The conclusion of our theorem follows in case (a) from Theorem 34.

It remains to show that if  $\int_{b \int_a P_0}^c f(x) dx$  exists, then  $\int_{b \int_a P_0}^b f(x) dx$  and  $\int_{b \int_b P_0}^c f(x) dx$  exist, and in that case also equation (1) holds. Suppose that on some sequence of sets  $[I]$  one of the two expressions  $\int_{a \bar{I}}^b f(x) dx$  and  $\int_{b \bar{\bar{I}}}^c f(x) dx$ , say  $\int_{a \bar{I}}^b f(x) dx$ , approaches two distinct values as  $m(I)$  approaches  $D$ . Since there is some sequence of sets of intervals  $\{\bar{I}'\}$  on which  $\int_{b \bar{\bar{I}'}}^c f(x)$  approaches only one value, it follows that on the sequence of sets of intervals obtained by associating with each  $\bar{I}$  an  $\bar{I}'$  and with each  $\bar{\bar{I}}$  an  $I'$ ,  $\int_{a I'}^c f(x) dx$  approaches two distinct values as  $m(I) \doteq D$ , which is contrary to hypothesis.

If  $\int_{a \bar{I}}^b f(x) dx$  approaches infinity, then clearly  $\int_{b \bar{\bar{I}}}^c f(x) dx$  must approach infinity of the opposite sign. Hence, by the corollary of Theorem 51a,  $\int_{a I}^c f(x) dx$  will approach both  $+\infty$  and  $-\infty$  as  $m(I) \doteq D$ , which again contradicts the hypothesis that  $\int_{b \int_a P_0}^c f(x) dx$  exists. The equality

$$\int_{a P_0}^c f(x) dx = \int_{a P_0}^b f(x) dx + \int_{b P_0}^c f(x) dx$$

now follows from the identity of the limitands

$$\int_{a I}^c f(x) dx \text{ and } \int_{a \bar{I}}^b f(x) dx + \int_{b \bar{\bar{I}}}^c f(x) dx.$$

**Theorem 162.** *If  $\int_{b \int_a P_0}^b f(x)dx$  exists, then  $\int_{b \int_b P_0}^a f(x)dx$  exists and*

$$\int_{b \int_a P_0}^b f(x)dx = - \int_{b \int_b P_0}^a f(x)dx.$$

**Proof.** By Theorem 108, for every  $I$

$$\int_a^b f(x)dx = - \int_b^a f(x)dx,$$

whence

$$\int_{b \int_a P_0}^b f(x)dx = - \int_{b \int_b P_0}^a f(x)dx.$$

**Theorem 163.** *If  $\int_{b \int_a P_0}^b f(x)dx$  exists, then  $\int_{b \int_a P_0}^b c \cdot f(x)dx$  exists and*

$$\int_{b \int_a P_0}^b c \cdot f(x)dx = c \cdot \int_{b \int_a P_0}^b f(x)dx.$$

**Proof.** This is a direct consequence of Theorems 111 and 34.

**Theorem 164.** *If  $\int_{b \int_a P_0}^b f_1(x)dx$  and  $\int_{b \int_a P_0}^b f_2(x)dx$  both exist, then  $\int_{b \int_a P_0}^b (f_1(x) \pm f_2(x))dx$  exists and*

$$\int_{b \int_a P_0}^b f_1(x)dx \pm \int_{b \int_a P_0}^b f_2(x)dx = \int_{b \int_a P_0}^b (f_1(x) \pm f_2(x))dx.$$

**Proof.** This is a direct consequence of Theorems 112 and 34.

**Theorem 165.** *If  $f_1(x) \geq f_2(x)$ , then*

$$\int_{b \int_a P_0}^b f_1(x)dx \geq \int_{b \int_a P_0}^b f_2(x)dx,$$

*provided these integrals exist.*

**Proof.** By Theorems 113 and 40.

**Theorem 166.** *If  $\int_{b \int_a P_0}^b f_1(x)dx$  and  $\int_{b \int_a P_0}^b f_2(x)dx$  both exist,*

$$\int_{b \int_a P_0}^b f_1(x) \cdot f_2(x)dx$$

*does not in general exist.*

**Proof.** Let  $f_1(x) = f_2(x) = \frac{1}{\sqrt{x}}$ . In this case the hypothesis of the theorem is verified but the product,  $\frac{1}{x}$ , fails to be integrable on the interval  $\overline{0\ 1}$ .

**Theorem 167.**  $\int_{a\ P_0}^x f(x)dx$  is a continuous function of  $x$ .

**Proof.** If  $x$  is a point at which the integral exists properly, the continuity follows by Theorem 118. If  $x$  is a point of the set  $P_0$ , then, by Theorem 26, we need to show that for every  $\varepsilon$  there is a  $\delta_\varepsilon$ , such that for every interval  $\overline{a'\ b'}$  containing  $x_1$  and of length less than  $\delta_\varepsilon$ ,  $\left| \int_{a'\ P_0}^{b'} f(x)dx \right| < \varepsilon$ . By definition there exists a  $\delta_\varepsilon$  such that for every  $I'$  and  $I''$  for which  $|m(I') - D| < \delta_\varepsilon$  and  $|m(I'') - D| < \delta_\varepsilon$ ,

$$\left| \int_{a\ I'}^b f(x)dx - \int_{a\ I''}^b f(x)dx \right| < \varepsilon.$$

Let  $\overline{a'\ b'}$  be an interval containing  $x_1$  such that

$$|a' - b'| < \frac{\delta_\varepsilon}{2}.$$

Let  $\overline{I'}$  be any set of intervals not containing any point of  $P_0$  and containing no point of  $\overline{a'\ b'}$ , and such that  $|m(\overline{I'}) - D| < \delta_\varepsilon$ . Denote by  $I_{(a'b')}$  any set of non-overlapping intervals on  $\overline{a'\ b'}$  containing no point of  $P_0$ , and let  $\overline{I''}$  be the set of all intervals in  $\overline{I'}$  and  $I_{(a'b')}$ . Then

$$|m(\overline{I''}) - D| < \delta_\varepsilon$$

and

$$\int_{a\ \overline{I''}}^b f(x)dx = \int_{a\ \overline{I'}}^b f(x)dx + \int_{a'\ I_{(a'b')}}^{b'} f(x)dx$$

and

$$\left| \int_{a'\ I_{(a'b')}}^{b'} f(x)dx \right| = \left| \int_{a\ \overline{I''}}^b f(x)dx \right| - \left| \int_{a\ \overline{I'}}^b f(x)dx \right|.$$

Hence

$$\left| \int_{a'\ P_0}^{b'} f(x)dx \right| \leq \varepsilon.$$

*Corollary.*—For  $x_1$  any point on  $\overline{a\ b}$

$$L_{x=x_1} \int_{b\ x_1}^x f(x)dx = 0.$$

**Theorem 168.** *If  $f(x)$  is integrable with respect to  $P_0$ , and if  $P_1$  is a set of points of content zero, then  $f(x)$  is integrable with respect to the set  $P_2$  consisting of all points in  $P_0$  and in  $P_1$  and*

$$\int_{b \int_a P_0}^b f(x)dx = \int_{b \int_a P_2}^b f(x)dx.$$

**Proof.** Obviously the set  $P_2$  is of content zero. Any set of intervals  $I$  not containing a point of  $P_2$  is also a set  $\bar{I}$  not containing a point of  $P_0$ . Hence any value approached by  $\int_{a \bar{I}}^b f(x)dx$  as  $m(\bar{I})$  approaches  $D$  is a value approached by  $\int_a^b f(x)dx$  as  $m(I)$  approaches  $D$ . Hence  $\int_{b \int_a P_2}^b f(x)dx$  exists and

$$\int_{b \int_a P_0}^b f(x)dx = \int_{b \int_a P_2}^b f(x)dx.$$

**Theorem 169.** *If  $f_1(x)$  is integrable with respect to  $P_1$  and  $f_2(x)$  is integrable with respect to  $P_2$ , then  $f_1(x) \pm f_2(x)$  is integrable with respect to the set,  $P_3$ , of all points in  $P_1$  and  $P_2$  and*

$$\int_{b \int_a P_1}^b f_1(x)dx \pm \int_{b \int_a P_2}^b f_2(x)dx = \int_{b \int_a P_3}^b (f_1(x) \pm f_2(x))dx.$$

**Proof.** By Theorem 168 each of the functions  $f_1(x)$  and  $f_2(x)$  is integrable with respect to  $P_3$ , and

$$\int_{b \int_a P_1}^b f_1(x)dx = \int_{b \int_a P_3}^b f_1(x)dx,$$

and

$$\int_{b \int_a P_2}^b f_2(x)dx = \int_{b \int_a P_3}^b f_2(x)dx,$$

and hence, by Theorem 164,  $f_1(x) \pm f_2(x)$  is integrable with respect to  $P_3$  and

$$\int_{b \int_a P_1}^b f_1(x)dx \pm \int_{b \int_a P_2}^b f_2(x)dx = \int_{b \int_a P_3}^b (f_1(x) \pm f_2(x))dx.$$

The broad improper definite integral as here defined contains as a special case the proper definite integral, the integral in that case existing properly at every point of the interval  $\overline{a b}$ . It does not, however, contain as a special case the simple improper definite integral considered in § 3. This may readily be shown by means of the function used on page 167 to show that the simple improper definite integral is not absolutely convergent. In the case of this function a sequence of sets of intervals  $I_a$  may be so chosen that  $\int_{a I_a}^b f(x)dx$  shall approach any value whatever as  $m(I_a)$  approaches  $D$ .

An improper integral which includes both the simple and the broad improper integrals is obtained as follows: Every set  $I$  is to be such that if  $I'$  is its complementary set of segments on  $\overline{a b}$ , then every segment of  $I'$  contains at least one point of  $P_0$ . The limit of  $\int_a^b f(x)dx$  as  $m(I)$  approaches  $D$ , if existent, is called the narrow improper definite integral and is denoted by  $\int_a^b f(x)dx$ .

It is evident that if the broad integral exists, then the narrow integral also exists. The narrow integral includes the simple improper definite integral of the preceding chapter. Hence it follows that the broad and the narrow integrals are not equivalent.<sup>11</sup> Theorems 161 to 167 hold of the narrow integral as well as of the broad integral. The proofs are identical with the above except that the sets  $I$  are limited as in the definition of the narrow integral. It may be shown by examples that Theorems 168 and 169 do not hold in the case of the narrow integral. To show that 168 does not hold consider the function defined in the proof of Theorem 160, where  $P_0$  consists of the point 0. Let  $P_1$  be the  $[x_i]$  of that example. Then obviously the narrow integral  $\int_0^1 f(x)dx$ , where  $P_2$  contains all the points of  $P_1$  and  $P_2$ , fails to exist. The same example shows that Theorem 169 does not hold of the narrow integral.

## § 5 Special Theorems on the Criteria of Existence of the Improper Definite Integral on a Finite Interval.

The examples of this section are intended to give an idea of the possible singularities of improperly integrable functions, and to indicate the difficulty of obtaining more general criteria of the divergence or convergence of the simple improper integral than those given in §§ 1 and 2 of this chapter.

**Lemma.**—*For every function  $f_1(x)$  which is unbounded in every neighborhood of  $x = a$  there is a function  $f_2(x)$  which is infinitesimal as  $x$  approaches  $a$ , such that  $f_1(x) \cdot f_2(x)$  is unbounded in every neighborhood of  $x = a$ , and such that*

$$\frac{f_2(x)}{x - a}$$

*is monotonic increasing as  $x$  approaches  $a$ .*

**Proof.** Since  $f_1(x)$  is unbounded in every neighborhood of  $x = a$ , it follows that for every point  $x_1$  of the segment  $\overline{a b}$  there is a point  $x_2$  on the segment  $\overline{a x_1}$  such that

$$|f_1(x_2)| > 2|f_1(x_1)| > 2M,$$

<sup>11</sup>The narrow integral is so called because it has fewer properties than the broad integral. It exists for a wider class of functions.



and such that

$$(x_2 - a) \leq \frac{1}{2}(x_1 - a).$$

Let  $x_1, x_2, x_3, \dots, x_n, \dots$  be a sequence of points dense only at  $a$  such that

$$|f_1(x_n)| > 2|f_1(x_{n-1})| > 2^{n-1} \cdot M,$$

and such that

$$|x_n - a| \leq \frac{1}{2}|x_{n-1} - a|.$$

We define  $f_2(x)$  as follows:

$$f_2(x) = \frac{1}{n} \text{ on the points } x_1, x_2, \dots, x_n, \dots$$

and  $f_2(x)$  is linear between the points of the sequence  $x_1, x_2, \dots, x_n, \dots$ . Then there are values of  $x$  on  $\overline{x_n x_{n-1}}$  such that

$$|f_1(x)| \cdot f_2(x) > \frac{2^{n-1}}{n} \cdot M,$$

whence  $f_1(x) \cdot f_2(x)$  is unbounded in the neighborhood of  $a$ .<sup>12</sup> Obviously  $\frac{f_2(x)}{x-a}$  is monotonic increasing as  $x$  approaches  $a$ .

**Theorem 170.** *For every function  $f_1(x)$  which is unbounded in every neighborhood of  $x = a$  there exists a non-oscillating function  $f_2(x)$  such that*

$$L_{x \dot{=} a} f_1(x) \int_x^b f_2(x) dx$$

*exists and is finite, while*

$$(x - a) \cdot f_1(x) \cdot f_2(x)$$

*is unbounded in the neighborhood of  $x = a$ .*

**Proof.** According to the lemma there exists a function  $f_3(x)$  such that

$$L_{x \dot{=} a} f_3(x) = 0,$$

while  $f_3(x) \cdot f_1(x)$  is unbounded and the function

$$f_4(x) = \frac{f_3(x)}{x - a}$$

---

<sup>12</sup>In case  $L_{x=0} f_1(x) = \infty$ ,  $f_2(x) = \frac{1}{\sqrt{f_1(x)}}$  or  $f_2(x) = \frac{1}{\log f_1(x)}$  would satisfy the requirements of the lemma except that they need not make  $\frac{f_2(x)}{x-a}$  monotonic.

is monotonic increasing as  $x$  approaches  $a$ . Since

$$(x - a)f_4(x) \cdot f_1(x) = f_3(x) \cdot f_1(x),$$

$(x - a) \cdot f_4(x) \cdot f_1(x)$  is unbounded in the neighborhood of  $x = a$ . Let  $x_1, \dots, x_n, \dots$  be a sequence of points on  $a \overline{b}$  whose only limit point is  $a$ , such that  $f_3(x) \cdot f_1(x)$  is unbounded on this set. In the sequence

$$(x_1 - a)f_4(x_1), \quad (x_2 - a)f_4(x_2), \quad \dots, \quad (x_n - a)f_4(x_n), \quad (1)$$

$L_{x \dot{=} a} (x_n - a)f_4(x_n) = 0$ , since  $L_{x \dot{=} a} (x - a)f_4(x) = 0$ . Hence there is a value of  $n$ ,  $n_1$ , such that

$$|(x_1 - a)f_4(x_1)| \geq 2|(x_{n_1} - a)f_4(x_{n_1})|,$$

and another value of  $n$ ,  $n_2$  such that

$$|(x_{n_1} - a)f_4(x_{n_1})| \geq 2|(x_{n_2} - a)f_4(x_{n_2})|, \text{ etc.},$$

$n_{m+1}$  being so chosen that

$$|(x_{n_m} - a)f_4(x_{n_m})| \geq 2|(x_{n_{m+1}} - a)f_4(x_{n_{m+1}})|.$$

In this manner we select from the sequence (1) a set of terms forming the convergent series

$$(x_1 - a)f_4(x_1) + (x_{n_1} - a)f_4(x_{n_1}) + \dots + (x_{n_m} - a)f_4(x_{n_m}) + \dots \quad (2)$$

We then obtain a function  $f_2(x)$  as follows: For the set of values of  $x$

$$x_{n_{m+1}} < x \leq x_{n_m}, \quad f_2(x) = f_4(x_{n_m}).$$

Then

(1)  $f_2(x)$  is non-oscillating since

$$f_4(x_{n_m}) < f_4(x_{n_{m+1}}).$$

(2)  $(x - a)f_2(x) \cdot f_1(x)$  is unbounded on the set  $x_1, x_{n_1}, x_{n_2}, \dots, x_{n_m}, \dots$ , since on this set

$$f_2(x) = f_4(x).$$

$$(3) \quad L_{x \dot{=} a} \int_x^b f_2(x) dx = \sum_{m=1}^{\infty} (x_{n_m} - x_{n_{m+1}}) f_4(x_{n_m}).$$

But the terms of this series are numerically smaller than the corresponding terms of the convergent series (2). Hence

$$L_{x \dot{=} a} \int_x^b f_2(x) dx$$

exists and is finite.

Theorem 170 may be regarded as showing that

$$L_{x \doteq a} (x - a)f_2(x) = 0$$

is a strong necessary condition that, under the hypothesis of Theorem 142,

$$L_{x \doteq a} \int_x^b f_2(x)dx$$

shall exist and be finite. For, according to Theorem 170, it is impossible to modify the function  $(x - a)$  by any factor  $f_1(x)$  which shall approach infinity so slowly that for every function  $f_2(x)$  where

$$L_{x \doteq a} \int_x^b f_2(x)dx$$

exists and is finite

$$L_{x \doteq a} (x - a)f_1(x) \cdot f_2(x) = 0. \text{ }^{13}$$

**Theorem 171.** For every function  $f_1(x)$  defined on the interval  $a b$  there exists a function  $f_2(x)$  such that

(1)  $f_2(x)$  is continuous and does not change sign on a certain neighborhood of  $x \doteq a$ .

(2)  $L_{x \doteq a} \int_x^b f_2(x)dx$  exists and is finite.

(3) For  $x$  on a certain set  $[x']$

$$L_{x \doteq a} \frac{f_1(x')}{f_2(x')} = 0.$$

**Proof.** Let  $x'_1, x'_2, \dots, x'_n, \dots$  be a set of points of the interval  $a b$  dense only at  $a$ . Let  $B_1, B_2, B_3, \dots, B_n, \dots$  be a set of numbers such that

$$B_n \cdot n|f_1(x'_n)| \geq 2 \cdot B_{n+1}(n + 1)|f_1(x'_{n+1})|. \quad (n = 1, 2, 3, \dots)$$

On the  $x$  axis lay off a set of segments  $[\sigma_n]$  such that  $\sigma_n$  is of length  $B_n$  and  $x_n$  is its middle point. On the segments  $\sigma_n$  as bases construct isosceles triangles on the positive side of the  $x$  axis whose altitudes are  $n \cdot |f_1(x)|$ . The measures of areas of these triangles form a convergent series. Let  $f_3(x)$  be any continuous, monotonic, unbounded function such that

$$L_{x \doteq a} \int_x^b f_3(x)dx$$

exists and is finite. We then define  $f_2(x)$  as the function represented by the following curve:

---

<sup>13</sup>See PRINGSHEIM, *Mathematische Annalen*, Vol. 37, pp. 591–604 (1890).

- (1) Those parts of the boundaries of the isosceles triangles just described which lie above the curve defined by  $f_3(x)$ .
- (2) Those parts of the curve defined by  $f_3(x)$  which lie outside the triangles or on their boundary.

Obviously the function so defined has the properties specified in the theorem, the points  $x'_1, x'_2, \dots, x'_n, \dots$  being the set  $[x']$  specified by (3) of the theorem.

Theorem 171 means that from the hypothesis that the improper definite integral of  $f(x)$  exists on  $a$   $\infty$  it is impossible to obtain any conclusion whatever as to the order of infinity or the rank of infinity of  $f(x)$  at  $x = a$ . This is what one would expect *a priori*, since the definite integral is a function of two parameters, while the necessary condition in terms of boundedness would be in terms of only one of these.

## § 6 Special Theorems on the Criteria of the Existence of the Improper Definite Integral on the Infinite Interval.

**Theorem 172.** For every function  $f_1(x)$  which is unbounded as  $x$  approaches  $\infty$  there exists a non-oscillating function  $f_2(x)$  such that

$$L_{x \rightarrow \infty} \int_a^x f_2(x) dx$$

exists and is finite, while  $(x - a)f_1(x) \cdot f_2(x)$  is unbounded as  $x$  approaches  $\infty$ .

**Proof.** Obviously the lemma of Theorem 170 can be stated so as to apply to the case where  $x$  approaches  $\infty$  instead of  $a$ . If then in the proof of Theorem 161 the set of points  $x_1 \dots x_n \dots$  is so taken that

$$L_{n \rightarrow \infty} x_n = \infty$$

instead of  $a$ , the proof of Theorem 161 applies with the exception that  $f_2(x)$  is non-oscillating *decreasing* instead of non-oscillating *increasing*.

**Theorem 173.** For every function  $f_1(x)$  defined on the interval  $a$   $\infty$  there exists a function  $f_2(x)$  such that

- (1)  $f_2(x)$  is continuous and does not change sign for  $x$  greater than a certain fixed number.
- (2)

$$L_{x \rightarrow \infty} \int_x^a f_2(x) dx$$

exists and is finite.

(3) For  $x$  on a certain set  $[x']$

$$L_{x \doteq \infty} \frac{f_1(x')}{f_2(x')} = 0.$$

**Proof.** Such a function  $f_2(x)$  may be defined in a manner analogous to that of the proof of Theorem 171.

The remarks as to the meaning of Theorems 170 and 171 apply with obvious modifications to Theorems 172 and 173.



# INDEX.

- Absolute convergence of infinite series, 56
- Absolute value, 11
- Algebraic
  - functions, 41
  - numbers, 14
- Approach to a limit, 47
- Axioms
  - of continuity, 3, 24
  - of the real number system, 9
- Bounds
  - of indetermination, 66
  - upper and lower, 2, 35
- Broad improper definite integral, 169
- Change of variable, 62, 100, 142
- Class, 2
- Closed set, 31
- Constant, 33
- Content of a set of points, 148
- Continuity
  - at a point, 48
  - axioms of, 3, 24
  - over an interval, 70
  - uniform, 70
- Continuous
  - function, 48
  - real number system, 3
- Continuum, linear, 3
- Convergence
  - of infinite series, 55
  - to a limit, 47
- Covering of interval or segment, 25
- Decreasing function, 36
- Dedekind cut, 5
- Definite integral, 122
- Dense, 31
- Dense in itself, 31
- Dependent variable, 33
- Derivative, 93
  - progressive and regressive, 93
- Derived function, 95
- Difference of irrational numbers, 6
- Differential, 102
- Differential coefficient, 104
- Discontinuity, 49
  - of the first and second kind, 66
- Discrete set, 31
- Divergence, 56
- Everywhere dense, 31
- Exponential function, 41
- Function, 33
  - algebraic, 41
  - continuity of
    - at a point, 48
    - over an interval, 70
  - exponential, 41
  - graph of, 34
  - infinite at a point, 81
  - inverse, 34
  - limit of, 47
  - monotonic
    - decreasing, 36
    - increasing, 36
  - non-oscillating, 36
  - oscillating, 36
  - partitively monotonic, 38
  - rational, 41
  - rational integral, 41

- transcendental, 41
  - unbounded, 35
  - uniform continuity of, 70
  - upper and lower bound of, 35
  - value approached by, 47
- Geometric series, 57
- Graph of a function, 34
- Greatest lower bound, 3
- Improper definite integral, 153
  - broad, 169
  - narrow, 174
  - simple, 164
- Improper existence of the definite integral, 164
- Increasing function, 36
- Independent variable, 33
- Infinite, 81, 82
- Infinite segment, 25
- Infinite series, 55
  - convergence and divergence of, 56
- Infinitesimals, 59
- Infinity as a limit, 30, 35, 47
- Integral
  - definite, 122
  - existing properly at a point, 164
- Integral oscillation, 124
- Interval, 24
- Inverse function, 34
- Irrational
  - number, 1, 3
  - numbers
    - difference of, 6
    - product of, 6
    - quotient of, 6
    - sum of, 6
- Least upper bound, 3
- L'Hospital's rule, 111
- Limit
  - lower, 66
  - of a function, 47
  - of integration, 123
  - point, 29
  - upper, 66
- Limitand function, 47
- Linear continuum, 3
- Logarithms, 44
- Lower bound
  - of a function, 35
  - of a set of numbers, 2
- Lower integral, 146
- Lower segment, 9
- Many-valued function, 33
- Maximum of a function, 104
- Mean-value theorem
  - of the differential calculus, 106
  - of the integral calculus, 136
- Minimum of a function, 104
- Monotonic function, 36
- Narrow improper definite integral, 174
- Necessary and sufficient condition, 51
- Neighborhood, 28
- Non-differentiable function, 120
- Non-integrable function, 124
- Non-numerably infinite set, 149
- Non-oscillating function, 36
- Nowhere dense, 31
- Number, 1
  - algebraic, 14
  - irrational, 1, 3
  - system, 3
- Numbers
  - sequence of, 55
  - sets of, 2
  - transcendental, 14
- Numerably infinite set, 149
- One-to-one correspondence, 23
- Order of function, 82
- Oscillation of a function, 36
  - at a point, 66
- Partitively monotonic, 38
- Perfect set, 31



- Polynomial, 41
- Product of irrational numbers, 6
- Progressive derivative, 93
- Proper existence of the definite integral at a point, 164
  
- Quotient of irrational numbers, 6
  
- Rank of infinitesimals and infinites, 91
- Ratio test for convergence of infinite series, 57
- Rational
  - functions, 41
  - integral functions, 41
  - numbers, 1
- Real number system, 3, 9
- Regressive derivative, 93
- Rolle's theorem, 105
  
- Segment, 24
  - infinite, 25
  - lower, 9
- Sequence of numbers, 55
- Series
  - geometric, 57
  - infinite, 55
    - convergence and divergence of, 56
  - Taylor's, 107, 108
- Sets of numbers, 2
- Simple improper definite integral, 164
- Single-valued functions, 33
- Singularity, 81
- Sum of irrational numbers, 6
  
- Taylor's series, 107
- Theorem of uniformity, 26
- Transcendental
  - functions, 41
  - numbers, 14
  
- Unbounded function, 35
- Uniform continuity, 70
- Uniformity, 26
- Upper
  - integral, 146
  - limit, 66
- Upper bound
  - of a function, 35
  - of a set of numbers, 2
  
- Value approached by
  - a function, 47
  - the independent variable, 47
- Variable
  - dependent, 33
  - independent, 33
- Vicinity, 28
- $V(a)$ , 28
- $V^*(a)$ , 28

# SHORT-TITLE CATALOGUE

OF THE  
PUBLICATIONS  
OF  
JOHN WILEY & SONS,  
NEW YORK.

LONDON: CHAPMAN & HALL, LIMITED.

---

ARRANGED UNDER SUBJECTS.

---

Descriptive circulars sent on application. Books marked with an asterisk (\*) are sold at *net* prices only. All books are bound in cloth unless otherwise stated.

---

## AGRICULTURE.

Armsby's Manual of Cattle-feeding. . . . .	12mo, \$1 75
Principles of Animal Nutrition. . . . .	8vo, 4 00
Budd and Hansen's American Horticultural Manual:	
Part I. Propagation, Culture, and Improvement. . . . .	12mo, 1 50
Part II. Systematic Pomology. . . . .	12mo, 1 50
Downing's Fruits and Fruit-trees of America. . . . .	8vo, 5 00
Elliott's Engineering for Land Drainage. . . . .	12mo, 1 50
Practical Farm Drainage. . . . .	12mo, 1 00
Graves's Forest Mensuration. . . . .	8vo, 4 00
Green's Principles of American Forestry. . . . .	12mo, 1 50
Grotenfelt's Principles of Modern Dairy Practice. (Woll.) . . . . .	12mo, 2 00
Kemp's Landscape Gardening. . . . .	12mo, 2 50
Maynard's Landscape Gardening as Applied to Home Decoration. . . . .	12mo, 1 50
* McKay and Larsen's Principles and Practice of Butter-making. . . . .	8vo, 1 50
Sanderson's Insects Injurious to Staple Crops. . . . .	12mo, 1 50
Insects Injurious to Garden Crops. (In preparation.)	
Insects Injuring Fruits. (In preparation.)	
Stockbridge's Rocks and Soils. . . . .	8vo, 2 50
Winton's Microscopy of Vegetable Foods. . . . .	8vo, 7 50
Woll's Handbook for Farmers and Dairymen. . . . .	16mo, 1 50

## ARCHITECTURE.

Baldwin's Steam Heating for Buildings.....	12mo,	2 50
Bashore's Sanitation of a Country House.....	12mo.	1 00
Berg's Buildings and Structures of American Railroads.....	4to,	5 00
Birkmire's Planning and Construction of American Theatres.....	8vo,	3 00
Architectural Iron and Steel.....	8vo,	3 50
Compound Riveted Girders as Applied in Buildings.....	8vo,	2 00
Planning and Construction of High Office Buildings.....	8vo,	3 50
Skeleton Construction in Buildings.....	8vo,	3 00
Brigg's Modern American School Buildings.....	8vo,	4 00
Carpenter's Heating and Ventilating of Buildings.....	8vo,	4 00
Freitag's Architectural Engineering.....	8vo,	3 50
Fireproofing of Steel Buildings.....	8vo,	2 50
French and Ives's Stereotomy.....	8vo,	2 50
Gerhard's Guide to Sanitary House-inspection.....	16mo,	1 00
Theatre Fires and Panics.....	12mo,	1 50
* Greene's Structural Mechanics.....	8vo,	2 50
Holly's Carpenters' and Joiners' Handbook.....	18mo,	75
Johnson's Statics by Algebraic and Graphic Methods.....	8vo,	2 00
Kidder's Architects' and Builders' Pocket-book.		
Rewritten Edition.....	16mo, mor.,	5 00
Merrill's Stones for Building and Decoration.....	8vo,	5 00
Non-metallic Minerals: Their Occurrence and Uses.....	8vo,	4 00
Monckton's Stair-building.....	4to,	4 00
Patton's Practical Treatise on Foundations.....	8vo,	5 00
Peabody's Naval Architecture.....	8vo,	7 50
Rice's Concrete-block Manufacture.....	8vo,	2 00
Richey's Handbook for Superintendents of Construction.....	16mo, mor.,	4 00
* Building Mechanics' Ready Reference Book. Carpenters'		
and Woodworkers' Edition.....	16mo, morocco,	1 50
Sabin's Industrial and Artistic Technology of Paints and Varnish.....	8vo,	3 00
Siebert and Biggin's Modern Stone-cutting and Masonry.....	8vo,	1 50
Snow's Principal Species of Wood.....	8vo,	3 50
Sondericker's Graphic Statics with Applications to Trusses, Beams,		
and Arches.....	8vo,	2 00
Towne's Locks and Builders' Hardware.....	18mo, morocco,	3 00
Wait's Engineering and Architectural Jurisprudence.....	8vo,	6 00
	Sheep,	6 50
Law of Operations Preliminary to Construction in Engineering		
and Architecture.....	8vo,	5 00
	Sheep,	5 50
Law of Contracts.....	8vo,	3 00
Wood's Rustless Coatings: Corrosion and Electrolysis of Iron		
and Steel.....	8vo,	4 00
Worcester and Atkinson's Small Hospitals, Establishment and		
Maintenance, Suggestions for Hospital Architecture,		
with Plans for a Small Hospital.....	12mo,	1 25
The World's Columbian Exposition of 1893.....	Large 4to,	1 00

## ARMY AND NAVY.

Bernadou's Smokeless Powder, Nitro-cellulose, and the Theory of the Cellulose Molecule. . . . .	12mo,	2 50
* Bruff's Text-book Ordnance and Gunnery. . . . .	8vo,	6 00
Chase's Screw Propellers and Marine Propulsion. . . . .	8vo,	3 00
Cloke's Gunner's Examiner. . . . .	8vo,	1 50
Craig's Azimuth. . . . .	4to,	3 50
Crehore and Squier's Polarizing Photo-chronograph. . . . .	8vo,	3 00
* Davis's Elements of Law. . . . .	8vo,	2 50
* Treatise on the Military Law of United States. . . . .	8vo,	7 00
	Sheep,	7 50
De Brack's Cavalry Outposts Duties. (Carr.) . . . . .	24mo, morocco,	2 00
Dietz's Soldier's First Aid Handbook. . . . .	16mo, morocco,	1 25
* Dudley's Military Law and the Procedure of Courts-martial. . . . .	Large 12mo,	2 50
Durand's Resistance and Propulsion of Ships. . . . .	8vo,	5 00
* Dyer's Handbook of Light Artillery. . . . .	12mo,	3 00
Eissler's Modern High Explosives. . . . .	8vo,	4 00
* Fiebege's Text-book on Field Fortification. . . . .	Small 8vo,	2 00
Hamilton's The Gunner's Catechism. . . . .	18mo,	1 00
* Hoff's Elementary Naval Tactics. . . . .	8vo,	1 50
Ingalls's Handbook of Problems in Direct Fire. . . . .	8vo,	4 00
* Ballistic Tables. . . . .	8vo,	1 50
* Lyons's Treatise on Electromagnetic Phenomena. Vols. I. and II. . . . .	8vo, each,	6 00
* Mahan's Permanent Fortifications. (Mercur.) . . . . .	8vo, half morocco,	7 50
Manual for Courts-martial. . . . .	16mo, morocco,	1 50
* Mercur's Attack of Fortified Places. . . . .	12mo,	2 00
* Elements of the Art of War. . . . .	8vo,	4 00
Metcalf's Cost of Manufactures—And the Administration of Workshops. . . . .	8vo,	5 00
* Ordnance and Gunnery. 2 vols. . . . .	12mo,	5 00
Murray's Infantry Drill Regulations. . . . .	18mo, paper,	10
Nixon's Adjutants' Manual. . . . .	24mo,	1 00
Peabody's Naval Architecture. . . . .	8vo,	7 50
* Phelps's Practical Marine Surveying. . . . .	8vo,	2 50
Powell's Army Officer's Examiner. . . . .	12mo,	4 00
Sharpe's Art of Subsisting Armies in War. . . . .	18mo, morocco,	1 50
* Tupes and Poole's Manual of Bayonet Exercises and Musketry Fencing. . . . .	24mo, leather,	50
* Walke's Lectures on Explosives. . . . .	8vo,	4 00
Weaver's Military Explosives. . . . .	8vo,	3 00
* Wheeler's Siege Operations and Military Mining. . . . .	8vo,	2 00
Winthrop's Abridgment of Military Law. . . . .	12mo,	2 50
Woodhull's Notes on Military Hygiene. . . . .	16mo,	1 50
Young's Simple Elements of Navigation. . . . .	16mo, morocco,	2 00

## ASSAYING.

Fletcher's Practical Instructions in Quantitative Assaying with the Blowpipe.....	12mo, morocco,	1 50
Furman's Manual of Practical Assaying.....	8vo,	3 00
Lodge's Notes on Assaying and Metallurgical Laboratory Experiments.....	8vo,	3 00
Low's Technical Methods of Ore Analysis.....	8vo,	3 00
Miller's Manual of Assaying.....	12mo,	1 00
Cyanide Process.....	12mo,	1 00
Minet's Production of Aluminum and its Industrial Use. (Waldo.).....	12mo,	2 50
O'Driscoll's Notes on the Treatment of Gold Ores.....	8vo,	2 00
Ricketts and Miller's Notes on Assaying.....	8vo,	3 00
Robine and Lenglen's Cyanide Industry. (Le Clerc.).....	8vo,	4 00
Ulke's Modern Electrolytic Copper Refining.....	8vo,	3 00
Wilson's Cyanide Processes.....	12mo,	1 50
Chlorination Process.....	12mo,	1 50

## ASTRONOMY.

Comstock's Field Astronomy for Engineers.....	8vo,	2 50
Craig's Azimuth.....	4to,	3 50
Crandall's Text-book on Geodesy and Least Squares.....	8vo,	3 00
Doolittle's Treatise on Practical Astronomy.....	8vo,	4 00
Gore's Elements of Geodesy.....	8vo,	2 50
Hayford's Text-book of Geodetic Astronomy.....	8vo,	3 00
Merriman's Elements of Precise Surveying and Geodesy.....	8vo,	2 50
* Michie and Harlow's Practical Astronomy.....	8vo,	3 00
* White's Elements of Theoretical and Descriptive Astronomy.....	12mo,	2 00

## BOTANY.

Davenport's Statistical Methods, with Special Reference to Biological Variation.....	16mo, morocco,	1 25
Thomé and Bennett's Structural and Physiological Botany.....	16mo,	2 25
Westermaier's Compendium of General Botany. (Schneider.).....	8vo,	2 00

## CHEMISTRY.

* Abegg's Theory of Electrolytic Dissociation. (Von Ende.).....	12mo,	1 25
Adriance's Laboratory Calculations and Specific Gravity Tables.....	12mo,	1 25
Alexeyeff's General Principles of Organic Synthesis. (Matthews.).....	8vo,	3 00
Allen's Tables for Iron Analysis.....	8vo,	3 00
Arnold's Compendium of Chemistry. (Mandel.).....	Small 8vo,	3 50
Austen's Notes for Chemical Students.....	12mo,	1 50
Bernadou's Smokeless Powder.—Nitro-cellulose, and Theory of the Cellulose Molecule.....	12mo,	2 50

* Browning's Introduction to the Rarer Elements.....	8vo,	1 50
Brush and Penfield's Manual of Determinative Mineralogy.....	8vo,	4 00
* Claassen's Beet-sugar Manufacture. (Hall and Rolfe.).....	8vo,	3 00
Classen's Quantitative Chemical Analysis by Electrolysis. (Boltwood.).....	8vo,	3 00
Cohn's Indicators and Test-papers.....	12mo,	2 00
Tests and Reagents.....	8vo,	3 00
Crafts's Short Course in Qualitative Chemical Analysis. (Schaeffer.).....	12mo,	1 50
* Danneel's Electrochemistry. (Merriam.).....	12mo,	1 25
Dolezalek's Theory of the Lead Accumulator (Storage Battery). (Von Ende.).....	12mo,	2 50
Drechsel's Chemical Reactions. (Merrill.).....	12mo,	1 25
Duhem's Thermodynamics and Chemistry. (Burgess.).....	8vo,	4 00
Eissler's Modern High Explosives.....	8vo,	4 00
Effront's Enzymes and their Applications. (Prescott.).....	8vo,	3 00
Erdmann's Introduction to Chemical Preparations. (Dunlap.).....	12mo,	1 25
Fletcher's Practical Instructions in Quantitative Assaying with the Blowpipe.....	12mo, morocco,	1 50
Fowler's Sewage Works Analyses.....	12mo,	2 00
Fresenius's Manual of Qualitative Chemical Analysis. (Wells.).....	8vo,	5 00
Manual of Qualitative Chemical Analysis. Part I. Descriptive. (Wells.).....	8vo,	3 00
System of Instruction in Quantitative Chemical Analysis. (Cohn.) 2 vols.....	8vo,	12 50
Fuertes's Water and Public Health.....	12mo,	1 50
Furman's Manual of Practical Assaying.....	8vo,	3 00
* Getman's Exercises in Physical Chemistry.....	12mo,	2 00
Gill's Gas and Fuel Analysis for Engineers.....	12mo,	1 25
* Gooch and Browning's Outlines of Qualitative Chemical Analysis.....	Small 8vo,	1 25
Grotenfelt's Principles of Modern Dairy Practice. (Woll.).....	12mo,	2 00
Groth's Introduction to Chemical Crystallography (Marshall).....	12mo,	1 25
Hammarsten's Text-book of Physiological Chemistry. (Mandel.).....	8vo,	4 00
Helm's Principles of Mathematical Chemistry. (Morgan.).....	12mo,	1 50
Hering's Ready Reference Tables (Conversion Factors).....	16mo, morocco,	2 50
Hind's Inorganic Chemistry.....	8vo,	3 00
* Laboratory Manual for Students.....	12mo,	1 00
Holleman's Text-book of Inorganic Chemistry. (Cooper.).....	8vo,	2 50
Text-book of Organic Chemistry. (Walker and Mott.).....	8vo,	2 50
* Laboratory Manual of Organic Chemistry. (Walker.).....	12mo,	1 00
Hopkins's Oil-chemists' Handbook.....	8vo,	3 00
Iddings's Rock Minerals.....	8vo,	5 00
Jackson's Directions for Laboratory Work in Physiological Chemistry.....	8vo,	1 25
Keep's Cast Iron.....	8vo,	2 50
Ladd's Manual of Quantitative Chemical Analysis.....	12mo,	1 00
Landauer's Spectrum Analysis. (Tingle.).....	8vo,	3 00
* Langworthy and Austen. The Occurrence of Aluminium in Vegetable Products, Animal Products, and Natural Waters.....	8vo,	2 00

Lassar-Cohn's Application of Some General Reactions to Investigations in Organic Chemistry. (Tingle.)	12mo,	1 00
Leach's The Inspection and Analysis of Food with Special Reference to State Control.	8vo,	7 50
Löb's Electrochemistry of Organic Compounds. (Lorenz.)	8vo,	3 00
Lodge's Notes on Assaying and Metallurgical Laboratory Experiments.	8vo,	3 00
Low's Technical Method of Ore Analysis.	8vo,	3 00
Lunge's Techno-chemical Analysis. (Cohn.)	12mo,	1 00
* McKay and Larsen's Principles and Practice of Butter-making.	8vo,	1 50
Mandel's Handbook for Bio-chemical Laboratory.	12mo,	1 50
* Martin's Laboratory Guide to Qualitative Analysis with the Blowpipe.	12mo,	60
Mason's Water-supply. (Considered Principally from a Sanitary Standpoint.) 3d Edition, Rewritten.	8vo,	4 00
Examination of Water. (Chemical and Bacteriological.)	12mo,	1 25
Matthew's The Textile Fibres.	8vo,	3 50
Meyer's Determination of Radicles in Carbon Compounds. (Tingle.)	12mo,	1 00
Miller's Manual of Assaying.	12mo,	1 00
Cyanide Process.	12mo,	1 00
Minet's Production of Aluminum and its Industrial Use. (Waldo.)	12mo,	2 50
Mixter's Elementary Text-book of Chemistry.	12mo,	1 50
Morgan's An Outline of the Theory of Solutions and its Results.	12mo,	1 00
Elements of Physical Chemistry.	12mo,	3 00
* Physical Chemistry for Electrical Engineers.	12mo,	1 50
Morse's Calculations used in Cane-sugar Factories.	16mo, morocco,	1 50
* Muir's History of Chemical Theories and Laws.	8vo,	4 00
Mulliken's General Method for the Identification of Pure Organic Compounds. Vol. I.	Large 8vo,	5 00
O'Brine's Laboratory Guide in Chemical Analysis.	8vo,	2 00
O'Driscoll's Notes on the Treatment of Gold Ores.	8vo,	2 00
Ostwald's Conversations on Chemistry. Part One. (Ramsey.)	12mo,	1 50
“ “ “ “ Part Two. (Turnbull.)	12mo,	2 00
* Pauli's Physical Chemistry in the Service of Medicine. (Fischer.)	12mo,	1 25
* Penfield's Notes on Determinative Mineralogy and Record of Mineral Tests.	8vo, paper,	50
Pictet's The Alkaloids and their Chemical Constitution. (Biddle.)	8vo,	5 00
Pinner's Introduction to Organic Chemistry. (Austen.)	12mo	1 50
Poole's Calorific Power of Fuels.	8vo,	3 00
Prescott and Winslow's Elements of Water Bacteriology, with Special Reference to Sanitary Water Analysis.	12mo,	1 25
* Reising's Guide to Piece-dyeing.	8vo,	25 00
Richards and Woodman's Air, Water, and Food from a Sanitary Standpoint.	8vo,	2 00
Ricketts and Russell's Skeleton Notes upon Inorganic Chemistry. (Part I. Non-metallic Elements.)	8vo, morocco,	75
Ricketts and Miller's Notes on Assaying.	8vo,	3 00
Rideal's Sewage and the Bacterial Purification of Sewage.	8vo,	3 50
Disinfection and the Preservation of Food.	8vo,	4 00
Riggs's Elementary Manual for the Chemical Laboratory.	8vo,	1 25

Robine and Lenglen's Cyanide Industry. (Le Clerc.)	8vo,	4 00
Ruddiman's Incompatibilities in Prescriptions.	8vo,	2 00
* Whys in Pharmacy.	12mo,	1 00
Sabin's Industrial and Artistic Technology of Paints and Varnish.	8vo,	3 00
Salkowski's Physiological and Pathological Chemistry. (Orndorff.)	8vo,	2 50
Schimpf's Text-book of Volumetric Analysis.	12mo,	2 50
Essentials of Volumetric Analysis.	12mo,	1 25
* Qualitative Chemical Analysis.	8vo,	1 25
Smith's Lecture Notes on Chemistry for Dental Students.	8vo,	2 50
Spencer's Handbook for Chemists of Beet-sugar Houses.	16mo, morocco,	3 00
Handbook for Cane Sugar Manufacturers.	16mo, morocco,	3 00
Stockbridge's Rocks and Soils.	8vo,	2 50
* Tillman's Elementary Lessons in Heat.	8vo,	1 50
* Descriptive General Chemistry.	8vo,	3 00
Treadwell's Qualitative Analysis. (Hall.)	8vo,	3 00
Quantitative Analysis. (Hall.)	8vo,	4 00
Turneure and Russell's Public Water-supplies.	8vo,	5 00
Van Deventer's Physical Chemistry for Beginners. (Boltwood.)	12mo,	1 50
* Walke's Lectures on Explosives.	8vo,	4 00
Ware's Beet-sugar Manufacture and Refining.	Small 8vo, cloth,	4 00
Washington's Manual of the Chemical Analysis of Rocks.	8vo,	2 00
Weaver's Military Explosives.	8vo,	3 00
Wehrenfennig's Analysis and Softening of Boiler Feed-Water.	8vo,	4 00
Wells's Laboratory Guide in Qualitative Chemical Analysis.	8vo,	1 50
Short Course in Inorganic Qualitative Chemical Analysis for		
Engineering Students.	12mo,	1 50
Text-book of Chemical Arithmetic.	12mo,	1 25
Whipple's Microscopy of Drinking-water.	8vo,	3 50
Wilson's Cyanide Processes.	12mo,	1 50
Chlorination Process.	12mo,	1 50
Winton's Microscopy of Vegetable Foods.	8vo,	7 50
Wulling's Elementary Course in Inorganic, Pharmaceutical, and Medical		
Chemistry.	12mo,	2 00

## CIVIL ENGINEERING.

### BRIDGES AND ROOFS. HYDRAULICS. MATERIALS OF ENGINEERING. RAILWAY ENGINEERING.

Baker's Engineers' Surveying Instruments.	12mo,	3 00
Bixby's Graphical Computing Table.	Paper 19 $\frac{1}{2}$ × 24 $\frac{1}{4}$ inches	25
Breed and Hosmer's Principles and Practice of Surveying.	8vo,	3 00
* Burr's Ancient and Modern Engineering and		
the Isthmian Canal.	8vo,	3 50
Comstock's Field Astronomy for Engineers.	8vo,	2 50
Crandall's Text-book on Geodesy and Least Squares.	8vo,	3 00
Davis's Elevation and Stadia Tables.	8vo,	1 00
Elliott's Engineering for Land Drainage.	12mo,	1 50
Practical Farm Drainage.	12mo,	1 00
* Fieberger's Treatise on Civil Engineering.	8vo,	5 00



Flemer's Phototopographic Methods and Instruments. . . . .	8vo,	5 00
Folwell's Sewerage. (Designing and Maintenance.) . . . . .	8vo,	3 00
Freitag's Architectural Engineering. 2d Edition, Rewritten. . . . .	8vo,	3 50
French and Ives's Stereotomy. . . . .	8vo,	2 50
Goodhue's Municipal Improvements. . . . .	12mo,	1 75
Gore's Elements of Geodesy. . . . .	8vo,	2 50
Hayford's Text-book of Geodetic Astronomy. . . . .	8vo,	3 00
Hering's Ready Reference Tables (Conversion Factors) . . . . .	16mo, morocco,	2 50
Howe's Retaining Walls for Earth. . . . .	12mo,	1 25
* Ives's Adjustments of the Engineer's Transit and Level. . . . .	16mo, Bds,	25
Ives and Hilts's Problems in Surveying. . . . .	16mo, morocco,	1 50
Johnson's (J. B.) Theory and Practice of Surveying. . . . .	Small 8vo,	4 00
Johnson's (L. J.) Statics by Algebraic and Graphic Methods. . . . .	8vo,	2 00
Laplace's Philosophical Essay on Probabilities (Truscott and Emory.) . . . . .	12mo,	2 00
Mahan's Treatise on Civil Engineering. (1873.) (Wood.) . . . . .	8vo,	5 00
* Descriptive Geometry. . . . .	8vo,	1 50
Merriman's Elements of Precise Surveying and Geodesy. . . . .	8vo,	2 50
Merriman and Brooks's Handbook for Surveyors. . . . .	16mo, morocco,	2 00
Nugent's Plane Surveying. . . . .	8vo,	3 50
Ogden's Sewer Design. . . . .	12mo,	2 00
Parsons's Disposal of Municipal Refuse. . . . .	8vo,	2 00
Patton's Treatise on Civil Engineering. . . . .	8vo half leather,	7 50
Reed's Topographical Drawing and Sketching. . . . .	4to,	5 00
Rideal's Sewage and the Bacterial Purification of Sewage. . . . .	8vo,	3 50
Siebert and Biggin's Modern Stone-cutting and Masonry. . . . .	8vo,	1 50
Smith's Manual of Topographical Drawing. (McMillan.) . . . . .	8vo,	2 50
Sondericker's Graphic Statics, with Applications to Trusses, Beams, and Arches. . . . .	8vo,	2 00
Taylor and Thompson's Treatise on Concrete, Plain and Reinforced. . . . .	8vo,	5 00
* Trautwine's Civil Engineer's Pocket-book. . . . .	16mo, morocco,	5 00
Venable's Garbage Crematories in America. . . . .	8vo,	2 00
Wait's Engineering and Architectural Jurisprudence. . . . .	8vo,	6 00
	Sheep,	6 50
Law of Operations Preliminary to Construction in Engineering and Architecture. . . . .	8vo,	5 00
	Sheep,	5 50
Law of Contracts. . . . .	8vo,	3 00
Warren's Stereotomy—Problems in Stone-cutting. . . . .	8vo,	2 50
Webb's Problems in the Use and Adjustment of Engineering Instruments. . . . .	16mo, morocco,	1 25
Wilson's Topographic Surveying. . . . .	8vo,	3 50

#### BRIDGES AND ROOFS.

Boller's Practical Treatise on the Construction of Iron Highway Bridges. . . . .	8vo,	2 00
* Thames River Bridge. . . . .	4to, paper,	5 00
Burr's Course on the Stresses in Bridges and Roof Trusses, Arched Ribs, and Suspension Bridges. . . . .	8vo,	3 50

Burr and Falk's Influence Lines for Bridge and Roof Computations.....	8vo,	3 00
Design and Construction of Metallic Bridges.....	8vo,	5 00
Du Bois's Mechanics of Engineering. Vol. II.....	Small 4to,	10 00
Foster's Treatise on Wooden Trestle Bridges.....	4to,	5 00
Fowler's Ordinary Foundations.....	8vo,	3 50
Greene's Roof Trusses.....	8vo,	1 25
Bridge Trusses.....	8vo,	2 50
Arches in Wood, Iron, and Stone.....	8vo,	2 50
Howe's Treatise on Arches.....	8vo,	4 00
Design of Simple Roof-trusses in Wood and Steel.....	8vo,	2 00
Symmetrical Masonry Arches.....	8vo,	2 50
Johnson, Bryan, and Turneure's Theory and Practice in the Designing of Modern Framed Structures.....	Small 4to,	10 00
Merriman and Jacoby's Text-book on Roofs and Bridges:		
Part I. Stresses in Simple Trusses.....	8vo,	2 50
Part II. Graphic Statics.....	8vo,	2 50
Part III. Bridge Design.....	8vo,	2 50
Part IV. Higher Structures.....	8vo,	2 50
Morison's Memphis Bridge.....	4to,	10 00
Waddell's De Pontibus, a Pocket-book for Bridge Engineers.....	16mo, morocco,	2 00
* Specifications for Steel Bridges.....	12mo,	5 00
Wright's Designing of Draw-spans. Two parts in one volume.....	8vo,	3 50

#### HYDRAULICS.

Barnes's Ice Formation.....	8vo,	3 00
Bazin's Experiments upon the Contraction of the Liquid Vein Issuing from an Orifice. (Trautwine.).....	8vo,	2 00
Bovey's Treatise on Hydraulics.....	8vo,	5 00
Church's Mechanics of Engineering.....	8vo,	6 00
Diagrams of Mean Velocity of Water in Open Channels.....	paper,	1 50
Hydraulic Motors.....	8vo,	2 00
Coffin's Graphical Solution of Hydraulic Problems.....	16mo, morocco,	2 50
Flather's Dynamometers, and the Measurement of Power.....	12mo,	3 00
Folwell's Water-supply Engineering.....	8vo,	4 00
Frizell's Water-power.....	8vo,	5 00
Fuertes's Water and Public Health.....	12mo,	1 50
Water-filtration Works.....	12mo,	2 50
Ganguillet and Kutter's General Formula for the Uniform Flow of Water in Rivers and Other Channels. (Hering and Trautwine.).....	8vo,	4 00
Hazen's Filtration of Public Water-supply.....	8vo,	3 00
Hazlehurst's Towers and Tanks for Water-works.....	8vo,	2 50
Herschel's 115 Experiments on the Carrying Capacity of Large, Riveted, Metal Conduits.....	8vo,	2 00
Mason's Water-supply. (Considered Principally from a Sanitary Standpoint.).....	8vo,	4 00
Merriman's Treatise on Hydraulics.....	8vo,	5 00
* Michie's Elements of Analytical Mechanics.....	8vo,	4 00
Schuyler's Reservoirs for Irrigation, Water-power, and Domestic Water-supply.....	Large 8vo,	5 00

* Thomas and Watt's Improvement of Rivers.....	4to,	6 00
Turneure and Russell's Public Water-supplies.....	8vo,	5 00
Wegmann's Design and Construction of Dams.....	4to,	5 00
Water-supply of the City of New York from 1658 to 1895.....	4to,	10 00
Whipple's Value of Pure Water.....	Large 12mo,	1 00
Williams and Hazen's Hydraulic Tables.....	8vo,	1 50
Wilson's Irrigation Engineering.....	Small 8vo,	4 00
Wolff's Windmill as a Prime Mover.....	8vo,	3 00
Wood's Turbines.....	8vo,	2 50
Elements of Analytical Mechanics.....	8vo,	3 00

#### MATERIALS OF ENGINEERING.

Baker's Treatise on Masonry Construction.....	8vo,	5 00
Roads and Pavements.....	8vo,	5 00
Black's United States Public Works.....	Oblong 4to,	5 00
* Bovey's Strength of Materials and Theory of Structures.....	8vo,	7 50
Burr's Elasticity and Resistance of the Materials of Engineering.....	8vo,	7 50
Byrne's Highway Construction.....	8vo,	5 00
Inspection of the Materials and Workmanship Employed in Construction.....	16mo,	3 00
Church's Mechanics of Engineering.....	8vo,	6 00
Du Bois's Mechanics of Engineering. Vol. I.....	Small 4to,	7 50
* Eckel's Cements, Limes, and Plasters.....	8vo,	6 00
Johnson's Materials of Construction.....	Large 8vo,	6 00
Fowler's Ordinary Foundations.....	8vo,	3 50
Graves's Forest Mensuration.....	8vo,	4 00
* Greene's Structural Mechanics.....	8vo,	2 50
Keep's Cast Iron.....	8vo,	2 50
Lanza's Applied Mechanics.....	8vo,	7 50
Marten's Handbook on Testing Materials. (Henning.) 2 vols.....	8vo,	7 50
Maurer's Technical Mechanics.....	8vo,	4 00
Merrill's Stones for Building and Decoration.....	8vo,	5 00
Merriman's Mechanics of Materials.....	8vo,	5 00
* Strength of Materials.....	12mo,	1 00
Metcalf's Steel. A Manual for Steel-users.....	12mo,	2 00
Patton's Practical Treatise on Foundations.....	8vo,	5 00
Richardson's Modern Asphalt Pavements.....	8vo,	3 00
Richey's Handbook for Superintendents of Construction.....	16mo, mor.,	4 00
* Ries's Clays: Their Occurrence, Properties, and Uses.....	8vo,	5 00
Rockwell's Roads and Pavements in France.....	12mo,	11 25
Sabin's Industrial and Artistic Technology of Paints and Varnish.....	8vo,	3 00
Smith's Materials of Machines.....	12mo,	1 00
Snow's Principal Species of Wood.....	8vo,	3 50
Spalding's Hydraulic Cement.....	12mo,	2 00
Text-book on Roads and Pavements.....	12mo,	2 00
Taylor and Thompson's Treatise on Concrete, Plain and Reinforced.....	8vo,	5 00

Thurston's Materials of Engineering. 3 Parts.....	8vo,	8 00
Part I. Non-metallic Materials of Engineering and Metallurgy.....	8vo,	2 00
Part II. Iron and Steel.....	8vo,	3 50
Part III. A Treatise on Brasses, Bronzes, and Other Alloys and their Constituents.....	8vo,	2 50
Tillson's Street Pavements and Paving Materials.....	8vo,	4 00
Waddell's De Pontibus (A Pocket-book for Bridge Engineers.).....	16mo, mor.,	2 00
Specifications for Steel Bridges.....	12mo,	1 25
Wood's (De V.) Treatise on the Resistance of Materials, and an Appendix on the Preservation of Timber.....	8vo,	2 00
Wood's (De V.) Elements of Analytical Mechanics.....	8vo,	3 00
Wood's (M. P.) Rustless Coatings: Corrosion and Electrolysis of Iron and Steel.....	8vo,	4 00

#### RAILWAY ENGINEERING.

Andrew's Handbook for Street Railway Engineers.....	3 × 5 inches, morocco,	1 25
Berg's Buildings and Structures of American Railroads.....	4to,	5 00
Brook's Handbook of Street Railroad Location.....	16mo, morocco,	1 50
Butt's Civil Engineer's Field-book.....	16mo, morocco,	2 50
Crandall's Transition Curve.....	16mo, morocco,	1 50
Railway and Other Earthwork Tables.....	8vo,	1 50
Dawson's "Engineering" and Electric Traction Pocket-book.....	16mo, morocco,	5 00
Dredge's History of the Pennsylvania Railroad: (1879).....	Paper,	5 00
Fisher's Table of Cubic Yards.....	Cardboard,	25
Godwin's Railroad Engineers' Field-book and Explorers' Guide.....	16mo, mor.,	2 50
Hudson's Tables for Calculating the Cubic Contents of Excavations and Embankments.....	8vo,	1 00
Molitor and Beard's Manual for Resident Engineers.....	16mo,	1 00
Nagle's Field Manual for Railroad Engineers.....	16mo, morocco,	3 00
Philbrick's Field Manual for Engineers.....	16mo, morocco,	3 00
Searles's Field Engineering.....	16mo, morocco,	3 00
Railroad Spiral.....	16mo, morocco,	1 50
Taylor's Prismoidal Formulæ and Earthwork.....	8vo,	1 50
* Trautwine's Method of Calculating the Cube Contents of Excavations and Embankments by the Aid of Diagrams.....	8vo,	2 00
The Field Practice of Laying Out Circular Curves for Railroads.....	12mo, morocco,	2 50
Cross-section Sheet.....	Paper,	25
Webb's Railroad Construction.....	16mo, morocco,	5 00
Economics of Railroad Construction.....	Large 12mo,	2 50
Wellington's Economic Theory of the Location of Railways.....	Small 8vo,	5 00

#### DRAWING.

Barr's Kinematics of Machinery.....	8vo,	2 50
-------------------------------------	------	------

* Bartlett's Mechanical Drawing. . . . .	8vo,	3 00
* " " " " Abridged Ed. . . . .	8vo,	1 50
Coolidge's Manual of Drawing. . . . .	8vo, paper,	1 00
Coolidge and Freeman's Elements of General Drafting for Mechanical Engineers. . . . .	Oblong 4to,	2 50
Durley's Kinematics of Machines. . . . .	8vo,	4 00
Emch's Introduction to Projective Geometry and its Applications. . . . .	8vo,	2 50
Hill's Text-book on Shades and Shadows, and Perspective. . . . .	8vo,	2 00
Jamison's Elements of Mechanical Drawing. . . . .	8vo,	2 50
Advanced Mechanical Drawing. . . . .	8vo,	2 00
Jones's Machine Design:		
Part I. Kinematics of Machinery. . . . .	8vo,	1 50
Part II. Form, Strength, and Proportions of Parts. . . . .	8vo,	3 00
MacCord's Elements of Descriptive Geometry. . . . .	8vo,	3 00
Kinematics; or, Practical Mechanism. . . . .	8vo,	5 00
Mechanical Drawing. . . . .	4to,	4 00
Velocity Diagrams. . . . .	8vo,	1 50
MacLeod's Descriptive Geometry. . . . .	Small 8vo,	1 50
* Mahan's Descriptive Geometry and Stone-cutting. . . . .	8vo,	1 50
Industrial Drawing. (Thompson.) . . . . .	8vo,	3 50
Moyer's Descriptive Geometry. . . . .	8vo,	2 00
Reed's Topographical Drawing and Sketching. . . . .	4to,	5 00
Reid's Course in Mechanical Drawing. . . . .	8vo,	2 00
Text-book of Mechanical Drawing and Elementary Machine Design. . . . .	8vo,	3 00
Robinson's Principles of Mechanism. . . . .	8vo,	3 00
Schwamb and Merrill's Elements of Mechanism. . . . .	8vo,	3 00
Smith's (R. S.) Manual of Topographical Drawing. (McMillan.) . . . . .	8vo,	2 50
Smith (A. W.) and Marx's Machine Design. . . . .	8vo,	3 00
* Titsworth's Elements of Mechanical Drawing. . . . .	Oblong 8vo,	1 25
Warren's Elements of Plane and Solid Free-hand Geometrical Drawing. . . . .	12mo,	1 00
Drafting Instruments and Operations. . . . .	12mo,	1 25
Manual of Elementary Projection Drawing. . . . .	12mo,	1 50
Manual of Elementary Problems in the Linear Perspective of Form and Shadow. . . . .	12mo,	1 00
Plane Problems in Elementary Geometry. . . . .	12mo,	1 25
Primary Geometry. . . . .	12mo,	75
Elements of Descriptive Geometry, Shadows, and Perspective. . . . .	8vo,	3 50
General Problems of Shades and Shadows. . . . .	8vo,	3 00
Elements of Machine Construction and Drawing. . . . .	8vo,	7 50
Problems, Theorems, and Examples in Descriptive Geometry. . . . .	8vo,	2 50
Weisbach's Kinematics and Power of Transmission. (Hermann and Klein.) . . . . .	8vo,	5 00
Whelpley's Practical Instruction in the Art of Letter Engraving. . . . .	12mo,	2 00
Wilson's (H. M.) Topographic Surveying. . . . .	8vo,	3 50
Wilson's (V. T.) Free-hand Perspective. . . . .	8vo,	2 50
Wilson's (V. T.) Free-hand Lettering. . . . .	8vo,	1 00
Woolf's Elementary Course in Descriptive Geometry. . . . .	Large 8vo,	3 00

## ELECTRICITY AND PHYSICS.

* Abegg's Theory of Electrolytic Dissociation. (Von Ende.)	12mo,	1 25
Anthony and Brackett's Text-book of Physics. (Magie.)	Small 8vo,	3 00
Anthony's Lecture-notes on the Theory of Electrical Measurements.	12mo,	1 00
Benjamin's History of Electricity.	8vo,	3 00
Voltaic Cell.	8vo,	3 00
Classen's Quantitative Chemical Analysis by Electrolysis. (Boltwood.)	8vo,	3 00
* Collins's Manual of Wireless Telegraphy.	12mo,	1 50
	Morocco,	2 00
Crehore and Squier's Polarizing Photo-chronograph.	8vo,	3 00
* Danneel's Electrochemistry. (Merriam.)	12mo,	1 25
Dawson's "Engineering" and Electric Traction Pocket-book.	16mo, morocco,	5 00
Dolezalek's Theory of the Lead Accumulator (Storage Battery). (Von Ende.)	12mo,	2 50
Duhem's Thermodynamics and Chemistry. (Burgess.)	8vo,	4 00
Flather's Dynamometers, and the Measurement of Power.	12mo,	3 00
Gilbert's De Magnete. (Mottelay.)	8vo,	2 50
Hanchett's Alternating Currents Explained.	12mo,	1 00
Hering's Ready Reference Tables (Conversion Factors)	16mo, morocco,	2 50
Holman's Precision of Measurements.	8vo,	2 00
Telescopic Mirror-scale Method, Adjustments, and Tests.	Large 8vo,	75
Kinzbrunner's Testing of Continuous-current Machines.	8vo,	2 00
Landauer's Spectrum Analysis. (Tingle.)	8vo,	3 00
Le Chatelier's High-temperature Measurements. (Boudouard—Burgess.)	12mo,	3 00
Löb's Electrochemistry of Organic Compounds. (Lorenz.)	8vo,	3 00
* Lyons's Treatise on Electromagnetic Phenomena. Vols. I. and II.	8vo, each,	6 00
* Michie's Elements of Wave Motion Relating to Sound and Light.	8vo,	4 00
Niaudet's Elementary Treatise on Electric Batteries. (Fishback.)	12mo,	50
* Parshall and Hobart's Electric Machine Design.	4to, half morocco,	12 50
Reagan's Locomotives: Simple, Compound, and Electric. New Edition.	Large 12mo,	2 50
* Rosenberg's Electrical Engineering. (Haldane Gee—Kinzbrunner.)	8vo,	1 50
Ryan, Norris, and Hoxie's Electrical Machinery. Vol. I.	8vo,	2 50
Thurston's Stationary Steam-engines.	8vo,	2 50
* Tillman's Elementary Lessons in Heat.	8vo,	1 50
Tory and Pitcher's Manual of Laboratory Physics.	Small 8vo,	2 00
Ulke's Modern Electrolytic Copper Refining.	8vo,	3 00

## LAW.

* Davis's Elements of Law.	8vo,	2 50
* Treatise on the Military Law of United States.	8vo,	7 00
*	Sheep,	7 50

* Dudley's Military Law and the Procedure of Courts-martial. . . . .	Large 12mo,	2 50
Manual for Courts-martial. . . . .	16mo, morocco,	1 50
Wait's Engineering and Architectural Jurisprudence. . . . .	8vo,	6 00
	Sheep,	6 50
Law of Operations Preliminary to Construction in Engineering and Architecture. . . . .	8vo,	5 00
	Sheep,	5 50
Law of Contracts. . . . .	8vo,	3 00
Winthrop's Abridgment of Military Law. . . . .	12mo,	2 50

## MANUFACTURES.

Bernadou's Smokeless Powder—Nitro-cellulose and Theory of the Cellulose Molecule. . . . .	12mo,	2 50
Bolland's Iron Founder. . . . .	12mo,	2 50
"The Iron Founder," Supplement. . . . .	12mo,	2 50
Encyclopedia of Founding and Dictionary of Foundry Terms Used in the Practice of Moulding. . . . .	12mo,	3 00
* Claassen's Beet-sugar Manufacture. (Hall and Rolfe.) . . . . .	8vo,	3 00
* Eckel's Cements, Limes, and Plasters. . . . .	8vo,	6 00
Eissler's Modern High Explosives. . . . .	8vo,	4 00
Effront's Enzymes and their Applications. (Prescott.) . . . . .	8vo,	3 00
Fitzgerald's Boston Machinist. . . . .	12mo,	1 00
Ford's Boiler Making for Boiler Makers. . . . .	18mo,	1 00
Hopkin's Oil-chemists' Handbook. . . . .	8vo,	3 00
Keep's Cast Iron. . . . .	8vo,	2 50
Leach's The Inspection and Analysis of Food with Special Reference to State Control. . . . .	Large 8vo,	7 50
* McKay and Larsen's Principles and Practice of Butter-making. . . . .	8vo,	1 50
Matthews's The Textile Fibres. . . . .	8vo,	3 50
Metcalf's Steel. A Manual for Steel-users. . . . .	12mo,	2 00
Metcalf's Cost of Manufactures—And the Administration of Workshops. . . . .	8vo,	5 00
Meyer's Modern Locomotive Construction. . . . .	4to,	10 00
Morse's Calculations used in Cane-sugar Factories. . . . .	16mo, morocco,	1 50
* Reisig's Guide to Piece-dyeing. . . . .	8vo,	25 00
Rice's Concrete-block Manufacture. . . . .	8vo,	2 00
Sabin's Industrial and Artistic Technology of Paints and Varnish. . . . .	8vo,	3 00
Smith's Press-working of Metals. . . . .	8vo,	3 00
Spalding's Hydraulic Cement. . . . .	12mo,	2 00
Spencer's Handbook for Chemists of Beet-sugar Houses. . . . .	16mo, morocco,	3 00
Handbook for Cane Sugar Manufacturers. . . . .	16mo, morocco,	3 00
Taylor and Thompson's Treatise on Concrete, Plain and Reinforced. . . . .	8vo,	5 00
Thurston's Manual of Steam-boilers, their Designs, Construction and Operation. . . . .	8vo,	5 00
* Walke's Lectures on Explosives. . . . .	8vo,	4 00
Ware's Beet-sugar Manufacture and Refining. . . . .	Small 8vo,	4 00
Weaver's Military Explosives. . . . .	8vo,	3 00





No. 1. History of Modern Mathematics, by David Eugene Smith.		
No. 2. Synthetic Projective Geometry, by George Bruce Halsted.		
No. 3. Determinants, by Laenas Gifford Weld. No. 4. Hyperbolic Functions, by James McMahon. No. 5. Harmonic Functions, by William E. Byerly. No. 6. Grassmann's Space Analysis, by Edward W. Hyde. No. 7. Probability and Theory of Errors, by Robert S. Woodward. No. 8. Vector Analysis and Quaternions, by Alexander Macfarlane. No. 9. Differential Equations, by William Woolsey Johnson. No. 10. The Solution of Equations, by Mansfield Merriman. No. 11. Functions of a Complex Variable, by Thomas S. Fiske.		
Maurer's Technical Mechanics.....	8vo,	4 00
Merriman's Method of Least Squares.....	8vo,	2 00
Rice and Johnson's Elementary Treatise on the Differential Calculus.....	Sm. 8vo,	3 00
Differential and Integral Calculus. 2 vols. in one.....	Small 8vo,	2 50
* Veblen and Lennes's Introduction to the Real Infinitesimal Analysis of One Variable.....	8vo,	2 00
Wood's Elements of Co-ordinate Geometry.....	8vo,	2 00
Trigonometry: Analytical, Plane, and Spherical.....	12mo,	1 00

## MECHANICAL ENGINEERING.

### MATERIALS OF ENGINEERING, STEAM-ENGINES AND BOILERS.

Bacon's Forge Practice.....	12mo,	1 50
Baldwin's Steam Heating for Buildings.....	12mo,	2 50
Barr's Kinematics of Machinery.....	8vo,	2 50
* Bartlett's Mechanical Drawing.....	8vo,	3 00
* " " " " Abridged Ed.....	8vo,	1 50
Benjamin's Wrinkles and Recipes.....	12mo,	2 00
Carpenter's Experimental Engineering.....	8vo,	6 00
Heating and Ventilating Buildings.....	8vo,	4 00
Clerk's Gas and Oil Engine.....	Small 8vo,	4 00
Coolidge's Manual of Drawing.....	8vo, paper,	1 00
Coolidge and Freeman's Elements of General Drafting for Mechanical Engineers.....	Oblong 4to,	2 50
Cromwell's Treatise on Toothed Gearing.....	12mo,	1 50
Treatise on Belts and Pulleys.....	12mo,	1 50
Durley's Kinematics of Machines.....	8vo,	4 00
Flather's Dynamometers and the Measurement of Power.....	12mo,	3 00
Rope Driving.....	12mo,	2 00
Gill's Gas and Fuel Analysis for Engineers.....	12mo,	1 25
Hall's Car Lubrication.....	12mo,	1 00
Hering's Ready Reference Tables (Conversion Factors).....	16mo, morocco,	2 50
Hutton's The Gas Engine.....	8vo,	5 00
Jamison's Mechanical Drawing.....	8vo,	2 50
Jones's Machine Design:		
Part I. Kinematics of Machinery.....	8vo,	1 50
Part II. Form, Strength, and Proportions of Parts.....	8vo,	3 00
Kent's Mechanical Engineers' Pocket-book.....	16mo, morocco,	5 00

Kerr's Power and Power Transmission.....	8vo,	2 00
Leonard's Machine Shop, Tools, and Methods.....	8vo,	4 00
* Lorenz's Modern Refrigerating Machinery. (Pope, Haven, and Dean.).....	8vo,	4 00
MacCord's Kinematics; or Practical Mechanism.....	8vo,	5 00
Mechanical Drawing.....	4to,	4 00
Velocity Diagrams.....	8vo,	1 50
MacFarland's Standard Reduction Factors for Gases.....	8vo,	1 50
Mahan's Industrial Drawing. (Thompson.).....	8vo,	3 50
Poole's Calorific Power of Fuels.....	8vo,	3 00
Reid's Course in Mechanical Drawing.....	8vo,	2 00
Text-book of Mechanical Drawing and Elementary Machine Design.....	8vo,	3 00
Richard's Compressed Air.....	12mo,	1 50
Robinson's Principles of Mechanism.....	8vo,	3 00
Schwamb and Merrill's Elements of Mechanism.....	8vo,	3 00
Smith's (O.) Press-working of Metals.....	8vo,	3 00
Smith (A. W.) and Marx's Machine Design.....	8vo,	3 00
Thurston's Treatise on Friction and Lost Work in Machinery and Mill Work.....	8vo,	3 00
Animal as a Machine and Prime Motor, and the Laws of Energetics.....	12mo,	1 00
Tillson's Complete Automobile Instructor.....	16mo,	1 50
	Morocco,	2 00
Warren's Elements of Machine Construction and Drawing.....	8vo,	7 50
Weisbach's Kinematics and the Power of Transmission. (Herrmann—Klein.).....	8vo,	5 00
Machinery of Transmission and Governors. (Herrmann—Klein.).....	8vo,	5 00
Wolff's Windmill as a Prime Mover.....	8vo,	3 00
Wood's Turbines.....	8vo,	2 50

#### MATERIALS OF ENGINEERING.

* Bovey's Strength of Materials and Theory of Structures.....	8vo,	7 50
Burr's Elasticity and Resistance of the Materials of Engineering. 6th Edition. Reset.....	8vo,	7 50
Church's Mechanics of Engineering.....	8vo,	6 00
* Greene's Structural Mechanics.....	8vo,	2 50
Johnson's Materials of Construction.....	8vo,	6 00
Keep's Cast Iron.....	8vo,	2 50
Lanza's Applied Mechanics.....	8vo,	7 50
Martens's Handbook on Testing Materials. (Henning.).....	8vo,	7 50
Maurer's Technical Mechanics.....	8vo,	4 00
Merriman's Mechanics of Materials.....	8vo,	5 00
* Strength of Materials.....	12mo,	1 00
Metcalf's Steel. A Manual for Steel-users.....	12mo,	2 00
Sabin's Industrial and Artistic Technology of Paints and Varnish.....	8vo,	3 00
Smith's Materials of Machines.....	12mo,	1 00
Thurston's Materials of Engineering.....	3 vols., 8vo,	8 00
Part II. Iron and Steel.....	8vo,	3 50

Part III. A Treatise on Brasses, Bronzes, and Other Alloys and their Constituents.....	8vo,	2 50
Wood's (De V.) Treatise on the Resistance of Materials and an Appendix on the Preservation of Timber.....	8vo,	2 00
Elements of Analytical Mechanics.....	8vo,	3 00
Wood's (M. P.) Rustless Coatings: Corrosion and Electrolysis of Iron and Steel.....	8vo,	4 00

#### STEAM-ENGINES AND BOILERS.

Berry's Temperature-entropy Diagram.....	12mo,	1 25
Carnot's Reflections on the Motive Power of Heat (Thurston.).....	12mo,	1 50
Dawson's "Engineering" and Electric Traction Pocket-book.....	16mo mor.,	5 00
Ford's Boiler Making for Boiler Makers.....	18mo,	1 00
Goss's Locomotive Sparks.....	8vo,	2 00
Locomotive Performance.....	8vo,	5 00
Hemenway's Indicator Practice and Steam-engine Economy.....	12mo,	2 00
Hutton's Mechanical Engineering of Power Plants.....	8vo,	5 00
Heat and Heat-engines.....	8vo,	5 00
Kent's Steam boiler Economy.....	8vo,	4 00
Kneass's Practice and Theory of the Injector.....	8vo,	1 50
MacCord's Slide-valves.....	8vo,	2 00
Meyer's Modern Locomotive Construction.....	4to,	10 00
Peabody's Manual of the Steam-engine Indicator.....	12mo,	1 50
Tables of the Properties of Saturated Steam and Other Vapors.....	8vo,	1 00
Thermodynamics of the Steam-engine and Other Heat-engines.....	8vo,	5 00
Valve-gears for Steam-engines.....	8vo,	2 50
Peabody and Miller's Steam-boilers.....	8vo,	4 00
Pray's Twenty Years with the Indicator.....	Large 8vo,	2 50
Pupin's Thermodynamics of Reversible Cycles in Gases and Saturated Vapors. (Osterberg.).....	12mo,	1 25
Reagan's Locomotives: Simple, Compound, and Electric.....	Large 12mo,	2 50
Rontgen's Principles of Thermodynamics. (Du Bois.).....	8vo,	5 00
Sinclair's Locomotive Engine Running and Management.....	12mo,	2 00
Smart's Handbook of Engineering Laboratory Practice.....	12mo,	2 50
Snow's Steam-boiler Practice.....	8vo,	3 00
Spangler's Valve-gears.....	8vo,	2 50
Notes on Thermodynamics.....	12mo,	1 00
Spangler, Greene, and Marshall's Elements of Steam-engineering.....	8vo,	3 00
Thomas's Steam-turbines.....	8vo,	3 50
Thurston's Handy Tables.....	8vo,	1 50
Manual of the Steam-engine.....	2 vols., 8vo,	10 00
Part I. History, Structure, and Theory.....	8vo,	6 00
Part II. Design, Construction, and Operation.....	8vo,	6 00
Handbook of Engine and Boiler Trials, and the Use of the Indicator and the Prony Brake.....	8vo,	5 00
Stationary Steam-engines.....	8vo,	2 50
Steam-boiler Explosions in Theory and in Practice.....	12mo,	1 50
Manual of Steam-boilers, their Designs, Construction, and Operation.....	8vo,	5 00

Wehrenfennig's Analysis and Softening of Boiler		
Feed-water (Patterson) .....	8vo,	4 00
Weisbach's Heat, Steam, and Steam-engines. (Du Bois.) .....	8vo,	5 00
Whitham's Steam-engine Design .....	8vo,	5 00
Wood's Thermodynamics, Heat Motors, and Refrigerating Machines .....	8vo,	4 00

## MECHANICS AND MACHINERY.

Barr's Kinematics of Machinery .....	8vo,	2 50
* Bovey's Strength of Materials and Theory of Structures .....	8vo,	7 50
Chase's The Art of Pattern-making .....	12mo,	2 50
Church's Mechanics of Engineering .....	8vo,	6 00
Notes and Examples in Mechanics .....	8vo,	2 00
Compton's First Lessons in Metal-working .....	12mo,	1 50
Compton and De Groodt's The Speed Lathe .....	12mo,	1 50
Cromwell's Treatise on Toothed Gearing .....	12mo,	1 50
Treatise on Belts and Pulleys .....	12mo,	1 50
Dana's Text-book of Elementary Mechanics for Colleges and Schools .....	12mo,	1 50
Dingey's Machinery Pattern Making .....	12mo,	2 00
Dredge's Record of the Transportation Exhibits Building of the World's Columbian Exposition of 1893 .....	4to half morocco,	5 00
Du Bois's Elementary Principles of Mechanics:		
Vol. I. Kinematics .....	8vo,	3 50
Vol. II. Statics .....	8vo,	4 00
Mechanics of Engineering. Vol. I .....	Small 4to,	7 50
Vol. II .....	Small 4to,	10 00
Durley's Kinematics of Machines .....	8vo,	4 00
Fitzgerald's Boston Machinist .....	16mo,	1 00
Flather's Dynamometers, and the Measurement of Power .....	12mo,	3 00
Rope Driving .....	12mo,	2 00
Goss's Locomotive Sparks .....	8vo,	2 00
Locomotive Performance .....	8vo,	5 00
* Greene's Structural Mechanics .....	8vo,	2 50
Hall's Car Lubrication .....	12mo,	1 00
Holly's Art of Saw Filing .....	18mo,	75
James's Kinematics of a Point and the Rational Mechanics of a Particle .....	Small 8vo,	2 00
* Johnson's (W. W.) Theoretical Mechanics .....	12mo,	3 00
Johnson's (L. J.) Statics by Graphic and Algebraic Methods .....	8vo,	2 00
Jones's Machine Design:		
Part I. Kinematics of Machinery .....	8vo,	1 50
Part II. Form, Strength, and Proportions of Parts .....	8vo,	3 00
Kerr's Power and Power Transmission .....	8vo,	2 00
Lanza's Applied Mechanics .....	8vo,	7 50
Leonard's Machine Shop, Tools, and Methods .....	8vo,	4 00
* Lorenz's Modern Refrigerating Machinery. (Pope, Haven, and Dean.) .....	8vo,	4 00
MacCord's Kinematics; or, Practical Mechanism .....	8vo,	5 00

Velocity Diagrams. ....	8vo,	1 50
* Martin's Text Book on Mechanics, Vol. I, Statics. ....	12mo,	1 25
Maurer's Technical Mechanics. ....	8vo,	4 00
Merriman's Mechanics of Materials. ....	8vo,	5 00
* Elements of Mechanics. ....	12mo,	1 00
* Michie's Elements of Analytical Mechanics. ....	8vo,	4 00
* Parshall and Hobart's Electric Machine Design. ....	4to, half morocco,	12 50
Reagan's Locomotives: Simple, Compound, and Electric. New Edition. ....	Large 12mo,	3 00
Reid's Course in Mechanical Drawing. ....	8vo,	2 00
Text-book of Mechanical Drawing and Elementary Machine Design. ....	8vo,	3 00
Richards's Compressed Air. ....	12mo,	1 50
Robinson's Principles of Mechanism. ....	8vo,	3 00
Ryan, Norris, and Hoxie's Electrical Machinery. Vol. I. ....	8vo,	2 50
Sanborn's Mechanics: Problems. ....	Large 12mo,	1 50
Schwamb and Merrill's Elements of Mechanism. ....	8vo,	3 00
Sinclair's Locomotive-engine Running and Management. ....	12mo,	2 00
Smith's (O.) Press-working of Metals. ....	8vo,	3 00
Smith's (A. W.) Materials of Machines. ....	12mo,	1 00
Smith (A. W.) and Marx's Machine Design. ....	8vo,	3 00
Spangler, Greene, and Marshall's Elements of Steam-engineering. ....	8vo,	3 00
Thurston's Treatise on Friction and Lost Work in Machinery and Mill Work. ....	8vo,	3 00
Animal as a Machine and Prime Motor, and the Laws of Energetics. ....	12mo,	1 00
Tillson's Complete Automobile Instructor. ....	16mo,	1 50
	Morocco,	2 00
Warren's Elements of Machine Construction and Drawing. ....	8vo,	7 50
Weisbach's Kinematics and Power of Transmission. (Herrmann—Klein.) ....	8vo,	5 00
Machinery of Transmission and Governors. (Herrmann—Klein.) ....	8vo,	5 00
Wood's Elements of Analytical Mechanics. ....	8vo,	3 00
Principles of Elementary Mechanics. ....	12mo,	1 25
Turbines. ....	8vo,	2 50
The World's Columbian Exposition of 1893. ....	4to,	1 00

## MEDICAL.

De Fursac's Manual of Psychiatry. (Rosanoff and Collins.) ....	Large 12mo,	2 50
Ehrlich's Collected Studies on Immunity. (Bolduan.) ....	8vo,	6 00
Hammarsten's Text-book on Physiological Chemistry. (Mandel.) ....	8vo,	4 00
Lassar-Cohn's Practical Urinary Analysis. (Lorenz.) ....	12mo,	1 00
* Pauli's Physical Chemistry in the Service of Medicine. (Fischer.) ....	12mo,	1 25
* Pozzi-Escot's The Toxins and Venoms and their Antibodies. (Cohn.) ....	12mo,	1 00
Rostoski's Serum Diagnosis. (Bolduan.) ....	12mo,	1 00
Salkowski's Physiological and Pathological Chemistry. (Orndorff.) ....	8vo,	2 50

* Satterlee's Outlines of Human Embryology. ....	12mo,	1 25
Steel's Treatise on the Diseases of the Dog. ....	8vo,	3 50
Von Behring's Suppression of Tuberculosis. (Bolduan.).....	12mo,	1 00
Wassermann's Immune Sera: Hæmolysis, Cytotoxins, and Precipitins. (Bolduan.) .....	12mo, cloth,	1 00
Woodhull's Notes on Military Hygiene.....	16mo,	1 50
* Personal Hygiene.....	12mo,	1 00
Wulling's An Elementary Course in Inorganic Pharmaceutical and Medical Chemistry.....	12mo,	2 00

## METALLURGY.

Egleston's Metallurgy of Silver, Gold, and Mercury:		
Vol. I. Silver.....	8vo,	7 50
Vol. II. Gold and Mercury.....	8vo,	7 50
Goessel's Minerals and Metals: A Reference Book. ....	16mo, mor.	3 00
* Iles's Lead-smelting. ....	12mo,	2 50
Keep's Cast Iron.....	8vo,	2 50
Kunhardt's Practice of Ore Dressing in Europe.....	8vo,	1 50
Le Chatelier's High-temperature Measurements. (Boudouard—Burgess.) .....	12mo,	3 00
Metcalf's Steel. A Manual for Steel-users.....	12mo,	2 00
Miller's Cyanide Process. ....	12mo,	1 00
Minet's Production of Aluminum and its Industrial Use. (Waldo.) .....	12mo,	2 50
Robine and Lenglen's Cyanide Industry. (Le Clerc.) .....	8vo,	4 00
Smith's Materials of Machines.....	12mo,	1 00
Thurston's Materials of Engineering. In Three Parts. ....	8vo,	8 00
Part II. Iron and Steel.....	8vo,	3 50
Part III. A Treatise on Brasses, Bronzes, and Other Alloys and their Constituents.....	8vo,	2 50
Ulke's Modern Electrolytic Copper Refining.....	8vo,	3 00

## MINERALOGY.

Barringer's Description of Minerals of Commercial Value. ....	Oblong, morocco,	2 50
Boyd's Resources of Southwest Virginia. ....	8vo,	3 00
Map of Southwest Virginia.....	Pocket-book form,	2 00
Brush's Manual of Determinative Mineralogy. (Penfield.) .....	8vo,	4 00
Chester's Catalogue of Minerals.....	8vo, paper,	1 00
Dictionary of the Names of Minerals. ....	Cloth,	1 25
8vo,	3 50	
Dana's System of Mineralogy.....	Large 8vo, half leather,	12 50
First Appendix to Dana's New "System of Mineralogy." .....	Large 8vo,	1 00
Text-book of Mineralogy. ....	8vo,	4 00
Minerals and How to Study Them.....	12mo,	1 50
Catalogue of American Localities of Minerals. ....	Large 8vo,	1 00

Manual of Mineralogy and Petrography.....	12mo,	2 00
Douglas's Untechnical Addresses on Technical Subjects.....	12mo,	1 00
Eakle's Mineral Tables.....	8vo,	1 25
Egleston's Catalogue of Minerals and Synonyms.....	8vo,	2 50
Goesel's Minerals and Metals: A Reference Book. ....	16mo, mor.	3 00
Groth's Introduction to Chemical Crystallography (Marshall).....	12mo,	1 25
Iddings's Rock Minerals.....	8vo,	5 00
Merrill's Non-metallic Minerals: Their Occurrence and Uses.....	8vo,	4 00
* Penfield's Notes on Determinative Mineralogy and Record of Mineral Tests. ....	8vo, paper,	50
* Richards's Synopsis of Mineral Characters.....	12mo, morocco,	1 25
* Ries's Clays: Their Occurrence, Properties, and Uses.....	8vo,	5 00
Rosenbusch's Microscopical Physiography of the Rock-making Minerals. (Iddings.).....	8vo,	5 00
* Tillman's Text-book of Important Minerals and Rocks. ....	8vo,	2 00

## MINING.

Boyd's Resources of Southwest Virginia.....	8vo,	3 00
Map of Southwest Virginia.....	Pocket-book form,	2 00
Douglas's Untechnical Addresses on Technical Subjects.....	12mo,	1 00
Eissler's Modern High Explosives. ....	8vo,	4 00
Goesel's Minerals and Metals: A Reference Book. ....	16mo, mor.	3 00
Goodyear's Coal-mines of the Western Coast of the United States.....	12mo,	2 50
Ihlseng's Manual of Mining. ....	8vo,	5 00
* Iles's Lead-smelting. ....	12mo,	2 50
Kunhardt's Practice of Ore Dressing In Europe. ....	8vo,	1 50
Miller's Cyanide Process. ....	12mo,	1 00
O'Driscoll's Notes on the Treatment of Gold Ores.....	8vo,	2 00
Robine and Lenglen's Cyanide Industry. (Le Clerc.) ....	8vo,	4 00
* Walke's Lectures on Explosives.....	8vo,	4 00
Weaver's Military Explosives.....	8vo,	3 00
Wilson's Cyanide Processes.....	12mo,	1 50
Chlorination Process.....	12mo,	1 50
Hydraulic and Placer Mining.....	12mo,	2 00
Treatise on Practical and Theoretical Mine Ventilation.....	12mo,	1 25

## SANITARY SCIENCE.

Bashore's Sanitation of a Country House.....	12mo,	1 00
* Outlines of Practical Sanitation.....	12mo,	1 25
Folwell's Sewerage. (Designing, Construction, and Maintenance.).....	8vo,	3 00
Water-supply Engineering.....	8vo,	4 00
Fowler's Sewage Works Analyses.....	12mo,	2 00
Fuertes's Water and Public Health.....	12mo,	1 50
Water-filtration Works.....	12mo,	2 50
Gerhard's Guide to Sanitary House-inspection.....	16mo,	1 00
Hazen's Filtration of Public Water-supplies.....	8vo,	3 00

Leach's The Inspection and Analysis of Food with Special Reference to State Control. ....	8vo,	7 50
Mason's Water-supply (Considered principally from a Sanitary Standpoint) .....	8vo,	4 00
Examination of Water. (Chemical and Bacteriological.) .....	12mo,	1 25
* Merriman's Elements of Sanitary Engineering. ....	8vo,	2 00
Ogden's Sewer Design. ....	12mo,	2 00
Prescott and Winslow's Elements of Water Bacteriology, with Special Reference to Sanitary Water Analysis. ....	12mo,	1 25
* Price's Handbook on Sanitation. ....	12mo,	1 50
Richards's Cost of Food. A Study in Dietaries. ....	12mo,	1 00
Cost of Living as Modified by Sanitary Science. ....	12mo,	1 00
Cost of Shelter. ....	12mo,	1 00
Richards and Woodman's Air, Water, and Food from a Sanitary Standpoint. ....	8vo,	2 00
* Richards and Williams's The Dietary Computer. ....	8vo,	1 50
Rideal's Sewage and Bacterial Purification of Sewage. ....	8vo,	4 00
Turneure and Russell's Public Water-supplies. ....	8vo,	5 00
Von Behring's Suppression of Tuberculosis. (Bolduan.) .....	12mo,	1 00
Whipple's Microscopy of Drinking-water. ....	8vo,	3 50
Winton's Microscopy of Vegetable Foods. ....	8vo,	7 50
Woodhull's Notes on Military Hygiene. ....	16mo,	1 50
* Personal Hygiene. ....	12mo,	1 00

## MISCELLANEOUS.

Emmons's Geological Guide-book of the Rocky Mountain Excursion of the International Congress of Geologists. ....	Large 8vo,	1 50
Ferrel's Popular Treatise on the Winds. ....	8vo,	4 00
Gannett's Statistical Abstract of the World. ....	24mo,	75
Haines's American Railway Management. ....	12mo,	2 50
Ricketts's History of Rensselaer Polytechnic Institute, 1824-1894. ....	Small 8vo,	3 00
Rotherham's Emphasized New Testament. ....	Large 8vo,	3 00
The World's Columbian Exposition of 1893. ....	4to,	1 00
Winslow's Elements of Applied Microscopy. ....	12mo,	1 50

## HEBREW AND CHALDEE TEXT-BOOKS.

Green's Elementary Hebrew Grammar. ....	12mo,	1 25
Hebrew Chrestomathy. ....	8vo,	2 00
Gesenius's Hebrew and Chaldee Lexicon to the Old Testament Scriptures. (Tregelles.) .....	Small 4to, half morocco,	5 00
Letteris's Hebrew Bible. ....	8vo,	2 25



End of Project Gutenberg's Introduction to Infinitesimal Analysis  
by Oswald Veblen and N. J. Lennes

\*\*\* END OF THIS PROJECT GUTENBERG EBOOK INFINITESIMAL ANALYSIS \*\*\*

\*\*\* This file should be named 18741-t.tex or 18741-t.zip \*\*\*  
\*\*\* or 18741-pdf.pdf or 18741-pdf.pdf \*\*\*  
This and all associated files of various formats will be found in:  
<http://www.gutenberg.org/1/8/7/4/18741/>

Produced by K.F. Greiner, Joshua Hutchinson, Laura Wisewell,  
Owen Whitby and the Online Distributed Proofreading Team at  
<http://www.pgdp.net> (This file was produced from images  
generously made available by Cornell University Digital  
Collections.)

Updated editions will replace the previous one--the old editions  
will be renamed.

Creating the works from public domain print editions means that no  
one owns a United States copyright in these works, so the Foundation  
(and you!) can copy and distribute it in the United States without  
permission and without paying copyright royalties. Special rules,  
set forth in the General Terms of Use part of this license, apply to  
copying and distributing Project Gutenberg-tm electronic works to  
protect the PROJECT GUTENBERG-tm concept and trademark. Project  
Gutenberg is a registered trademark, and may not be used if you  
charge for the eBooks, unless you receive specific permission. If  
you do not charge anything for copies of this eBook, complying with  
the rules is very easy. You may use this eBook for nearly any  
purpose such as creation of derivative works, reports, performances  
and research. They may be modified and printed and given away--you  
may do practically ANYTHING with public domain eBooks.  
Redistribution is subject to the trademark license, especially  
commercial redistribution.

\*\*\* START: FULL LICENSE \*\*\*

THE FULL PROJECT GUTENBERG LICENSE PLEASE READ THIS BEFORE YOU  
DISTRIBUTE OR USE THIS WORK

To protect the Project Gutenberg-tm mission of promoting the free distribution of electronic works, by using or distributing this work (or any other work associated in any way with the phrase "Project Gutenberg"), you agree to comply with all the terms of the Full Project Gutenberg-tm License (available with this file or online at <http://gutenberg.net/license>).

## Section 1. General Terms of Use and Redistributing Project Gutenberg-tm electronic works

1.A. By reading or using any part of this Project Gutenberg-tm electronic work, you indicate that you have read, understand, agree to and accept all the terms of this license and intellectual property (trademark/copyright) agreement. If you do not agree to abide by all the terms of this agreement, you must cease using and return or destroy all copies of Project Gutenberg-tm electronic works in your possession. If you paid a fee for obtaining a copy of or access to a Project Gutenberg-tm electronic work and you do not agree to be bound by the terms of this agreement, you may obtain a refund from the person or entity to whom you paid the fee as set forth in paragraph 1.E.8.

1.B. "Project Gutenberg" is a registered trademark. It may only be used on or associated in any way with an electronic work by people who agree to be bound by the terms of this agreement. There are a few things that you can do with most Project Gutenberg-tm electronic works even without complying with the full terms of this agreement. See paragraph 1.C below. There are a lot of things you can do with Project Gutenberg-tm electronic works if you follow the terms of this agreement and help preserve free future access to Project Gutenberg-tm electronic works. See paragraph 1.E below.

1.C. The Project Gutenberg Literary Archive Foundation ("the Foundation" or PGLAF), owns a compilation copyright in the collection of Project Gutenberg-tm electronic works. Nearly all the individual works in the collection are in the public domain in the United States. If an individual work is in the public domain in the United States and you are located in the United States, we do not claim a right to prevent you from copying, distributing, performing, displaying or creating derivative works based on the work as long as all references to Project Gutenberg are removed. Of course, we hope that you will support the Project Gutenberg-tm mission of promoting free access to electronic works by freely sharing Project Gutenberg-tm works in compliance with the terms of this agreement

for keeping the Project Gutenberg-tm name associated with the work. You can easily comply with the terms of this agreement by keeping this work in the same format with its attached full Project Gutenberg-tm License when you share it without charge with others.

1.D. The copyright laws of the place where you are located also govern what you can do with this work. Copyright laws in most countries are in a constant state of change. If you are outside the United States, check the laws of your country in addition to the terms of this agreement before downloading, copying, displaying, performing, distributing or creating derivative works based on this work or any other Project Gutenberg-tm work. The Foundation makes no representations concerning the copyright status of any work in any country outside the United States.

1.E. Unless you have removed all references to Project Gutenberg:

1.E.1. The following sentence, with active links to, or other immediate access to, the full Project Gutenberg-tm License must appear prominently whenever any copy of a Project Gutenberg-tm work (any work on which the phrase "Project Gutenberg" appears, or with which the phrase "Project Gutenberg" is associated) is accessed, displayed, performed, viewed, copied or distributed:

This eBook is for the use of anyone anywhere at no cost and with almost no restrictions whatsoever. You may copy it, give it away or re-use it under the terms of the Project Gutenberg License included with this eBook or online at [www.gutenberg.net](http://www.gutenberg.net)

1.E.2. If an individual Project Gutenberg-tm electronic work is derived from the public domain (does not contain a notice indicating that it is posted with permission of the copyright holder), the work can be copied and distributed to anyone in the United States without paying any fees or charges. If you are redistributing or providing access to a work with the phrase "Project Gutenberg" associated with or appearing on the work, you must comply either with the requirements of paragraphs 1.E.1 through 1.E.7 or obtain permission for the use of the work and the Project Gutenberg-tm trademark as set forth in paragraphs 1.E.8 or 1.E.9.

1.E.3. If an individual Project Gutenberg-tm electronic work is posted with the permission of the copyright holder, your use and distribution must comply with both paragraphs 1.E.1 through 1.E.7 and any additional terms imposed by the copyright holder. Additional terms will be linked to the Project Gutenberg-tm License

for all works posted with the permission of the copyright holder found at the beginning of this work.

1.E.4. Do not unlink or detach or remove the full Project Gutenberg-tm License terms from this work, or any files containing a part of this work or any other work associated with Project Gutenberg-tm.

1.E.5. Do not copy, display, perform, distribute or redistribute this electronic work, or any part of this electronic work, without prominently displaying the sentence set forth in paragraph 1.E.1 with active links or immediate access to the full terms of the Project Gutenberg-tm License.

1.E.6. You may convert to and distribute this work in any binary, compressed, marked up, nonproprietary or proprietary form, including any word processing or hypertext form. However, if you provide access to or distribute copies of a Project Gutenberg-tm work in a format other than "Plain Vanilla ASCII" or other format used in the official version posted on the official Project Gutenberg-tm web site ([www.gutenberg.net](http://www.gutenberg.net)), you must, at no additional cost, fee or expense to the user, provide a copy, a means of exporting a copy, or a means of obtaining a copy upon request, of the work in its original "Plain Vanilla ASCII" or other form. Any alternate format must include the full Project Gutenberg-tm License as specified in paragraph 1.E.1.

1.E.7. Do not charge a fee for access to, viewing, displaying, performing, copying or distributing any Project Gutenberg-tm works unless you comply with paragraph 1.E.8 or 1.E.9.

1.E.8. You may charge a reasonable fee for copies of or providing access to or distributing Project Gutenberg-tm electronic works provided that

- You pay a royalty fee of 20% of the gross profits you derive from the use of Project Gutenberg-tm works calculated using the method you already use to calculate your applicable taxes. The fee is owed to the owner of the Project Gutenberg-tm trademark, but he has agreed to donate royalties under this paragraph to the Project Gutenberg Literary Archive Foundation. Royalty payments must be paid within 60 days following each date on which you prepare (or are legally required to prepare) your periodic tax returns. Royalty payments should be clearly marked as such and sent to the Project Gutenberg Literary Archive Foundation at the

address specified in Section 4, "Information about donations to the Project Gutenberg Literary Archive Foundation."

- You provide a full refund of any money paid by a user who notifies you in writing (or by e-mail) within 30 days of receipt that s/he does not agree to the terms of the full Project Gutenberg-tm License. You must require such a user to return or destroy all copies of the works possessed in a physical medium and discontinue all use of and all access to other copies of Project Gutenberg-tm works.
- You provide, in accordance with paragraph 1.F.3, a full refund of any money paid for a work or a replacement copy, if a defect in the electronic work is discovered and reported to you within 90 days of receipt of the work.
- You comply with all other terms of this agreement for free distribution of Project Gutenberg-tm works.

1.E.9. If you wish to charge a fee or distribute a Project Gutenberg-tm electronic work or group of works on different terms than are set forth in this agreement, you must obtain permission in writing from both the Project Gutenberg Literary Archive Foundation and Michael Hart, the owner of the Project Gutenberg-tm trademark. Contact the Foundation as set forth in Section 3 below.

#### 1.F.

1.F.1. Project Gutenberg volunteers and employees expend considerable effort to identify, do copyright research on, transcribe and proofread public domain works in creating the Project Gutenberg-tm collection. Despite these efforts, Project Gutenberg-tm electronic works, and the medium on which they may be stored, may contain "Defects," such as, but not limited to, incomplete, inaccurate or corrupt data, transcription errors, a copyright or other intellectual property infringement, a defective or damaged disk or other medium, a computer virus, or computer codes that damage or cannot be read by your equipment.

1.F.2. LIMITED WARRANTY, DISCLAIMER OF DAMAGES - Except for the "Right of Replacement or Refund" described in paragraph 1.F.3, the Project Gutenberg Literary Archive Foundation, the owner of the Project Gutenberg-tm trademark, and any other party distributing a Project Gutenberg-tm electronic work under this agreement, disclaim all liability to you for damages, costs and expenses, including

legal fees. YOU AGREE THAT YOU HAVE NO REMEDIES FOR NEGLIGENCE, STRICT LIABILITY, BREACH OF WARRANTY OR BREACH OF CONTRACT EXCEPT THOSE PROVIDED IN PARAGRAPH F3. YOU AGREE THAT THE FOUNDATION, THE TRADEMARK OWNER, AND ANY DISTRIBUTOR UNDER THIS AGREEMENT WILL NOT BE LIABLE TO YOU FOR ACTUAL, DIRECT, INDIRECT, CONSEQUENTIAL, PUNITIVE OR INCIDENTAL DAMAGES EVEN IF YOU GIVE NOTICE OF THE POSSIBILITY OF SUCH DAMAGE.

1.F.3. LIMITED RIGHT OF REPLACEMENT OR REFUND - If you discover a defect in this electronic work within 90 days of receiving it, you can receive a refund of the money (if any) you paid for it by sending a written explanation to the person you received the work from. If you received the work on a physical medium, you must return the medium with your written explanation. The person or entity that provided you with the defective work may elect to provide a replacement copy in lieu of a refund. If you received the work electronically, the person or entity providing it to you may choose to give you a second opportunity to receive the work electronically in lieu of a refund. If the second copy is also defective, you may demand a refund in writing without further opportunities to fix the problem.

1.F.4. Except for the limited right of replacement or refund set forth in paragraph 1.F.3, this work is provided to you 'AS-IS', WITH NO OTHER WARRANTIES OF ANY KIND, EXPRESS OR IMPLIED, INCLUDING BUT NOT LIMITED TO WARRANTIES OF MERCHANTABILITY OR FITNESS FOR ANY PURPOSE.

1.F.5. Some states do not allow disclaimers of certain implied warranties or the exclusion or limitation of certain types of damages. If any disclaimer or limitation set forth in this agreement violates the law of the state applicable to this agreement, the agreement shall be interpreted to make the maximum disclaimer or limitation permitted by the applicable state law. The invalidity or unenforceability of any provision of this agreement shall not void the remaining provisions.

1.F.6. INDEMNITY - You agree to indemnify and hold the Foundation, the trademark owner, any agent or employee of the Foundation, anyone providing copies of Project Gutenberg-tm electronic works in accordance with this agreement, and any volunteers associated with the production, promotion and distribution of Project Gutenberg-tm electronic works, harmless from all liability, costs and expenses, including legal fees, that arise directly or indirectly from any of the following which you do or cause to occur: (a) distribution of

this or any Project Gutenberg-tm work, (b) alteration, modification, or additions or deletions to any Project Gutenberg-tm work, and (c) any Defect you cause.

## Section 2. Information about the Mission of Project Gutenberg-tm

Project Gutenberg-tm is synonymous with the free distribution of electronic works in formats readable by the widest variety of computers including obsolete, old, middle-aged and new computers. It exists because of the efforts of hundreds of volunteers and donations from people in all walks of life.

Volunteers and financial support to provide volunteers with the assistance they need, is critical to reaching Project Gutenberg-tm's goals and ensuring that the Project Gutenberg-tm collection will remain freely available for generations to come. In 2001, the Project Gutenberg Literary Archive Foundation was created to provide a secure and permanent future for Project Gutenberg-tm and future generations. To learn more about the Project Gutenberg Literary Archive Foundation and how your efforts and donations can help, see Sections 3 and 4 and the Foundation web page at <http://www.pglaf.org>.

## Section 3. Information about the Project Gutenberg Literary Archive Foundation

The Project Gutenberg Literary Archive Foundation is a non profit 501(c)(3) educational corporation organized under the laws of the state of Mississippi and granted tax exempt status by the Internal Revenue Service. The Foundation's EIN or federal tax identification number is 64-6221541. Its 501(c)(3) letter is posted at <http://pglaf.org/fundraising>. Contributions to the Project Gutenberg Literary Archive Foundation are tax deductible to the full extent permitted by U.S. federal laws and your state's laws.

The Foundation's principal office is located at 4557 Melan Dr. S. Fairbanks, AK, 99712., but its volunteers and employees are scattered throughout numerous locations. Its business office is located at 809 North 1500 West, Salt Lake City, UT 84116, (801) 596-1887, email [business@pglaf.org](mailto:business@pglaf.org). Email contact links and up to date contact information can be found at the Foundation's web site and official page at <http://pglaf.org>

For additional contact information:

Dr. Gregory B. Newby  
Chief Executive and Director  
gbnewby@pglaf.org

#### Section 4. Information about Donations to the Project Gutenberg Literary Archive Foundation

Project Gutenberg-tm depends upon and cannot survive without wide spread public support and donations to carry out its mission of increasing the number of public domain and licensed works that can be freely distributed in machine readable form accessible by the widest array of equipment including outdated equipment. Many small donations (\$1 to \$5,000) are particularly important to maintaining tax exempt status with the IRS.

The Foundation is committed to complying with the laws regulating charities and charitable donations in all 50 states of the United States. Compliance requirements are not uniform and it takes a considerable effort, much paperwork and many fees to meet and keep up with these requirements. We do not solicit donations in locations where we have not received written confirmation of compliance. To SEND DONATIONS or determine the status of compliance for any particular state visit <http://pglaf.org>

While we cannot and do not solicit contributions from states where we have not met the solicitation requirements, we know of no prohibition against accepting unsolicited donations from donors in such states who approach us with offers to donate.

International donations are gratefully accepted, but we cannot make any statements concerning tax treatment of donations received from outside the United States. U.S. laws alone swamp our small staff.

Please check the Project Gutenberg Web pages for current donation methods and addresses. Donations are accepted in a number of other ways including including checks, online payments and credit card donations. To donate, please visit: <http://pglaf.org/donate>

#### Section 5. General Information About Project Gutenberg-tm electronic works.

Professor Michael S. Hart is the originator of the Project Gutenberg-tm concept of a library of electronic works that could be



freely shared with anyone. For thirty years, he produced and distributed Project Gutenberg-tm eBooks with only a loose network of volunteer support.

Project Gutenberg-tm eBooks are often created from several printed editions, all of which are confirmed as Public Domain in the U.S. unless a copyright notice is included. Thus, we do not necessarily keep eBooks in compliance with any particular paper edition.

Most people start at our Web site which has the main PG search facility:

<http://www.gutenberg.net>

This Web site includes information about Project Gutenberg-tm, including how to make donations to the Project Gutenberg Literary Archive Foundation, how to help produce our new eBooks, and how to subscribe to our email newsletter to hear about new eBooks.

\*\*\* END: FULL LICENSE \*\*\*